

MAX40200

Ultra-Tiny Micropower, 1A Ideal Diode with Ultra-Low Voltage Drop

General Description

The MAX40200 is an ideal diode current-switch that drops so little voltage that it approaches an order of magnitude better than Schottky diodes.

When forward-biased and enabled, the MAX40200 conducts with as little as 85mV of voltage drop while carrying currents as high as 1A. Typical voltage drop is 43mV at 500mA, with the voltage drop increasing linearly at higher currents. The MAX40200 thermally protects itself, and any downstream circuitry, from overtemperature conditions.

When disabled (EN = low) the MAX40200 blocks voltages up to 6V in either direction, making it suitable for most low-voltage, portable electronic devices. The MAX40200 operates from a supply voltage of 1.5V to 5.5V.

The MAX40200 is available in a tiny, 0.73mm X 0.73mm, 4-bump wafer-level package (WLP), with a 0.35mm bump pitch and only 0.5mm high and 5-pin SOT-23 package. The MAX40200 operates over the extended -40°C to +125°C temperature range.

Applications

- Notebook and Tablet Computers
- Portable Media Players
- Cellular Phones
- Portable/Wearable Medical Devices
- Electronic Toys
- USB-Powered Peripherals

Ordering Information appears at end of data sheet.

Benefits and Features

- Save Critical Voltage Drop in Portable Application
 - Drops Less Than 43mV at 500mA; 85mV at 1A
- Longer Battery Life
 - Low Leakage When Reverse-Biased : 70nA (Typ), 1.5µA (Max)
 - Low Supply Quiescent Current: 7µA (Typ), 18µA (Max)
- Saves Space Over Larger Schottky Diodes
 - Tiny 0.73mm x 0.73mm 4-bump WLP
 - SOT23-5 Package
- Supply Voltage Range 1.5V to 5.5V
- Thermally Self-Protecting
- -40°C to +125°C Temperature Range

Functional Diagram and Package

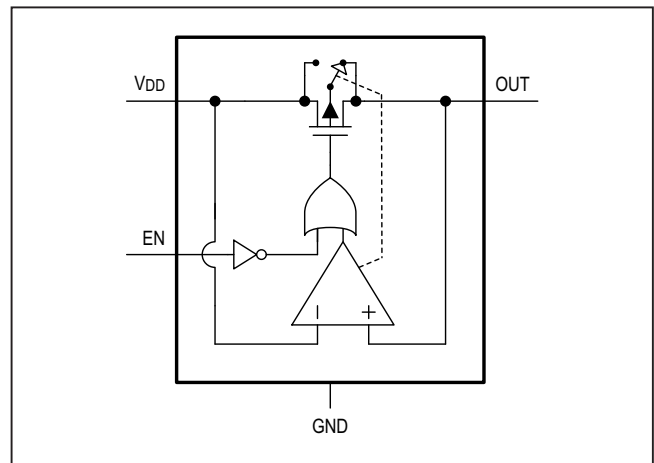

Absolute Maximum Ratings

Any Pin to GND.....	-0.3V to +6V	4 WLP
Continuous Current Into EN.....	10mA	Thermal Resistance (Multi-Layer Board)
Continuous Current Flowing Between V _{DD} and OUT (WLP Package).....	1.2A	Junction to Ambient (θ _{JA}).....
Continuous current flowing between V _{DD} and OUT (SOT23-5 Package).....	1.0A	5 SOT-23
Maximum Power Dissipation		Thermal Resistance (Multi-Layer Board)
WLP, Derate 9.58mW/°C above +70°C.....	766mW	Junction to Ambient (θ _{JA}).....
SOT, Derate 3.90mW/°C above +70°C.....	312.60mW	Junction to Case (θ _{JC}).....
		Operating Temperature Range.....
		Junction Temperature.....
		Storage Temperature Range.....
		Reflow Soldering Peak Temperature (Pb-free).....

Stresses beyond those listed under "Absolute Maximum Ratings" may cause permanent damage to the device. These are stress ratings only, and functional operation of the device at these or any other conditions beyond those indicated in the operational sections of the specifications is not implied. Exposure to absolute maximum rating conditions for extended periods may affect device reliability.

Note 1: Package thermal resistances were obtained using the method described in JEDEC specification JESD51-7, using a four-layer board. For detailed information on package thermal considerations, refer to www.maximintegrated.com/thermal-tutorial.

Electrical Characteristics

V_{DD} = 3.3V, GND = 0V, EN = V_{DD}, T_A = -40°C to +125°C, unless otherwise noted. Typical values are at +25°C (Note 2)

PARAMETER	SYMBOL	CONDITIONS	MIN	TYP	MAX	UNITS
Supply Voltage Range	V _{DD}	Guaranteed by ΔV _{ON_FRWD}	1.5		5.5	V
Quiescent Current	I _{DD}	EN = V _{DD} , I _{FORWARD} = 0 mA		7	18	μA
		EN = V _{GND} , I _{FORWARD} = 0 mA		0.7	2.5	
Quiescent Current in Reverse Operation		Current drawn from V _{DD} ; V _{OUT} - V _{DD} = 0.1V	-1.5	0.072	1.5	μA
		Current drawn from OUT; V _{OUT} - V _{DD} = 0.1V		1.2	3.5	
V _{DD} Leakage Current		Current sourced into V _{DD} ; V _{DD} = 0V, V _{OUT} = 5.5V	-5.5	-0.55	+2.5	μA
Forward Turn-On Threshold Voltage	V _{ON_FRWD}	Voltage between V _{DD} and OUT (V _{DD} more positive than OUT) I _{FORWARD} = 1mA		18	40	mV
Forward Turn-On Threshold Voltage Change Over Supply Voltage	ΔV _{ON_FRWD}	V _{DD} = 1.5V to 5.5V	-3	+0.2	+3	mV
Reverse Turn-Off Threshold	V _{OFF_REV}	Voltage between V _{DD} and V _{OUT}		20		mV
Forward Voltage (V _{DD} - V _{OUT}) (WLP Only)	V _{FWD}	I _{FORWARD} = 100mA		21	52	mV
		I _{FORWARD} = 200mA	V _{DD} = 1.5V	45	89	
			V _{DD} = 3.3V	24	57	
		I _{FORWARD} = 500mA		43	89	
		I _{FORWARD} = 1A		85	175	
Forward Voltage (V _{DD} - V _{OUT}) (SOT Only)	V _{FWD}	I _{FORWARD} = 100mA		32	65	mV
		I _{FORWARD} = 200mA	V _{DD} = 1.5V	63	110	
			V _{DD} = 3.3V	46	90	
		I _{FORWARD} = 500mA		97	175	
		I _{FORWARD} = 1A (Note 3)		197	350	

Electrical Characteristics (continued)

$V_{DD} = 3.3V$, $GND = 0V$, $EN = V_{DD}$, $T_A = -40^{\circ}C$ to $+125^{\circ}C$, unless otherwise noted. Typical values are at $+25^{\circ}C$ (Note 2)

PARAMETER	SYMBOL	CONDITIONS	MIN	TYP	MAX	UNITS
Capacitive Load Range	C_{OUT}	Stable for all load currents		0.3 - 100		μF
Thermal Protection Threshold				154		$^{\circ}C$
Thermal Protection Hysteresis				10		$^{\circ}C$
ENABLE (EN) CHARACTERISTICS						
Low-Level Input Current		$EN = 0V$	-1	-0.1	+0.1	μA
Low-Level Voltage Level	LOW				0.6	V
High Input Voltage Level	HIGH		1.2			V
High Level Input Current		$EN = V_{DD}$		0.5	2.5	μA
Enable Input Hysteresis				50		mV
Enable Time		$I_{FORWARD}$ reaching 90% of its final value with a resistive load ($R_{OUT} = 33\Omega$ and $4.7\mu F$, enable input toggled from 0V to 3.3V		65		μs
Disable Time		$I_{FORWARD}$ prior to disable = 100mA, $I_{FORWARD}$ reaching $\leq 1mA$ resistive load ($R_{OUT} = 33\Omega$ and $4.7\mu F$, enable input toggled from 0V to 3.3V		1.6		ms
Power-Up Delay Time				65		μs

Note 2: All devices are production tested at $T_A = +25^{\circ}C$. Specifications over temperature are guaranteed by design

Note 3: 1A pulsed current in duty cycle used for this test to make sure the device's self heating is negligible. For more information, see *Thermal Performance and Power Dissipation Information* section.

Typical Operating Characteristics

$V_{DD} = 3.3V$, $GND = 0V$, $EN = V_{DD}$, 100mA load or $I_{FORWARD}$ and $10\mu F$ C_{OUT} on OUT , $T_A = -40^{\circ}C$ to $+125^{\circ}C$, unless otherwise noted. Typical values are at $+25^{\circ}C$.

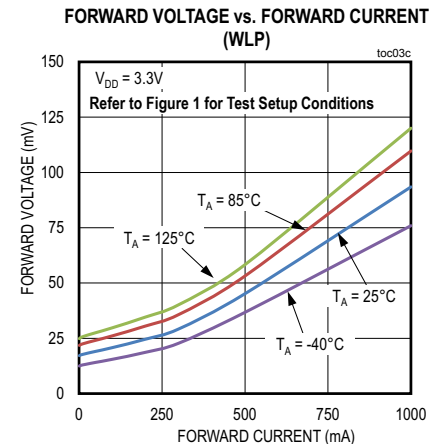
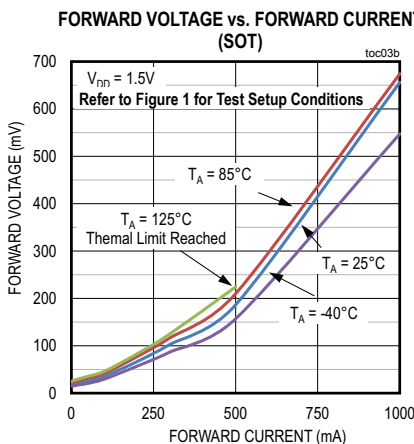
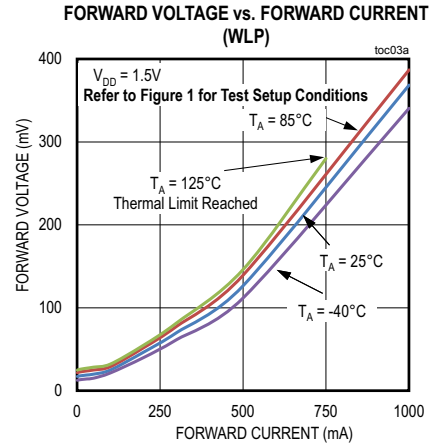
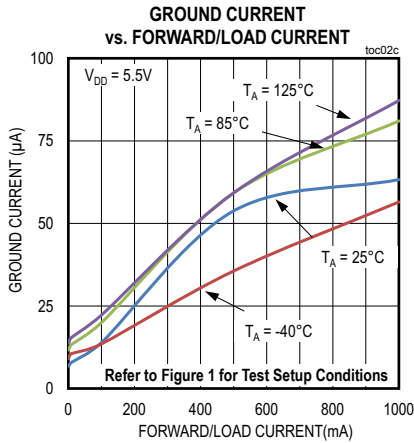
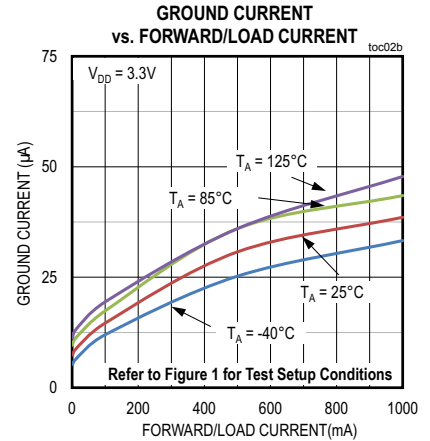
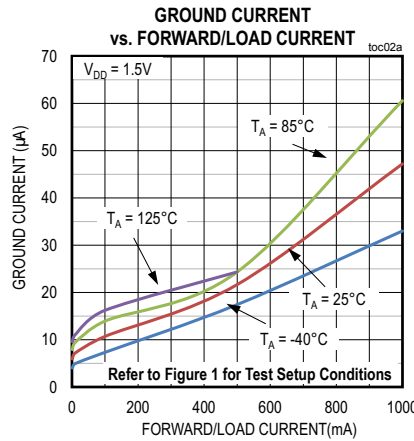
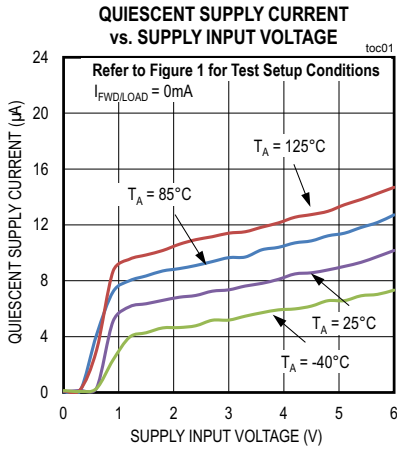

Typical Operating Characteristics (continued)

$V_{DD} = 3.3V$, $GND = 0V$, $EN = V_{DD}$, 100mA load or $I_{FORWARD}$ and $10\mu F$ C_{OUT} on OUT , $T_A = -40^{\circ}C$ to $+125^{\circ}C$, unless otherwise noted. Typical values are at $+25^{\circ}C$.

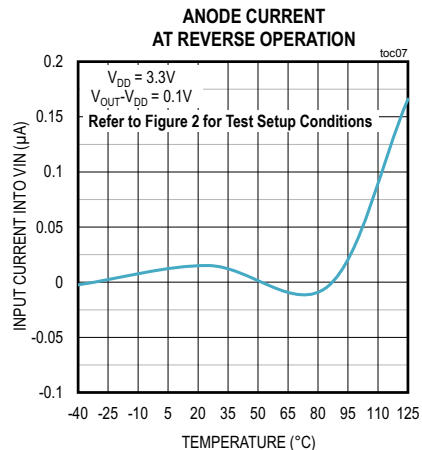
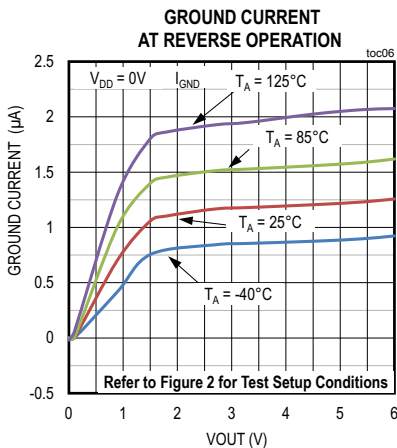
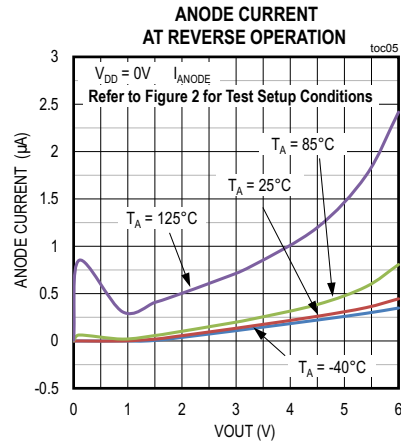
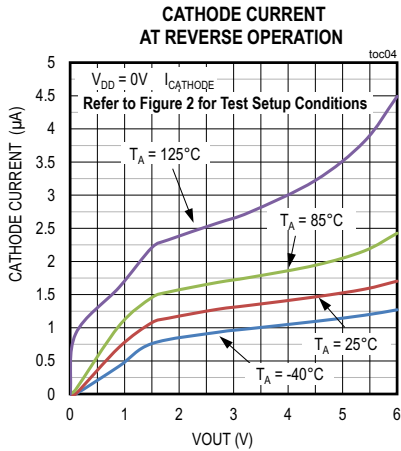
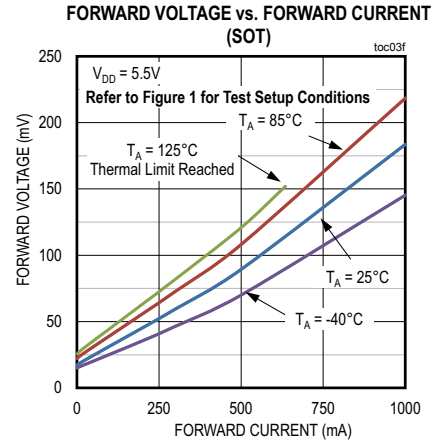
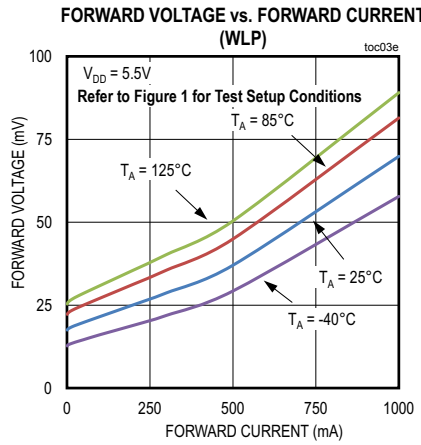
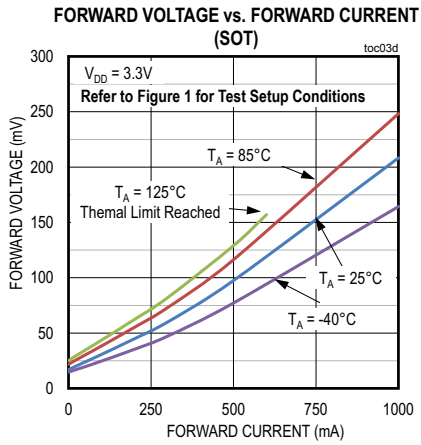

Typical Operating Characteristics (continued)

V_{DD} = 3.3V, GND = 0V, EN = V_{DD}, 100mA load or I_{FORWARD} and 10μF C_{OUT} on OUT, T_A = -40°C to +125°C, unless otherwise noted. Typical values are at +25°C.

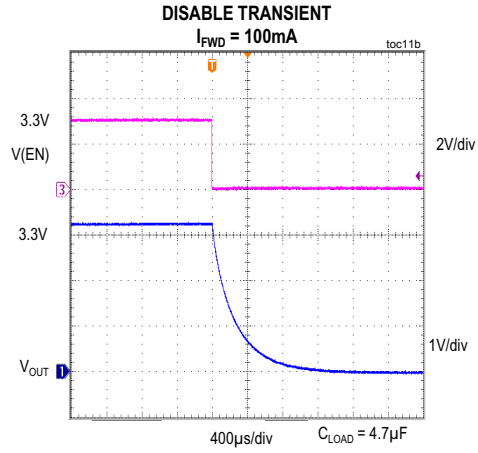
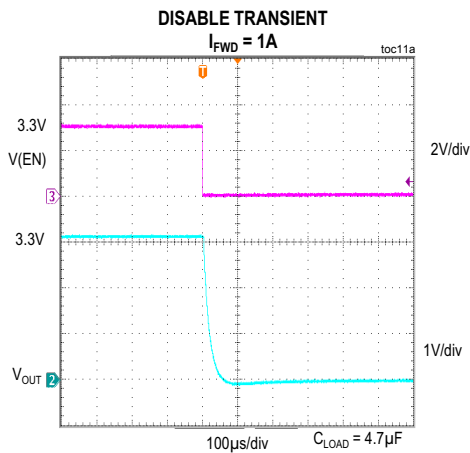
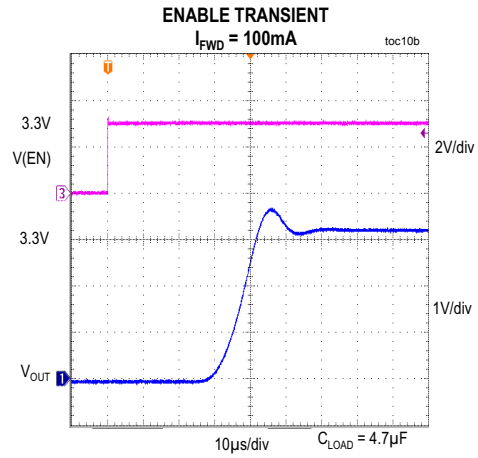
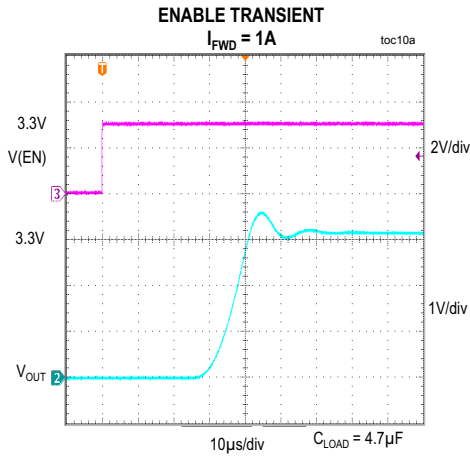
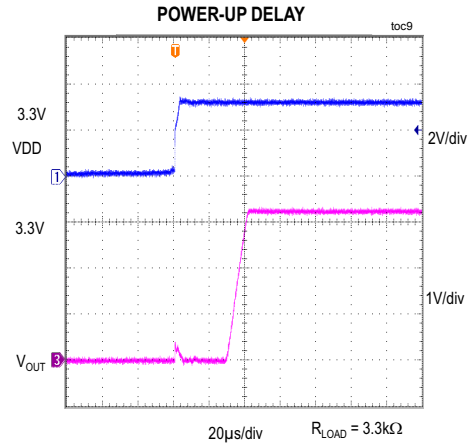
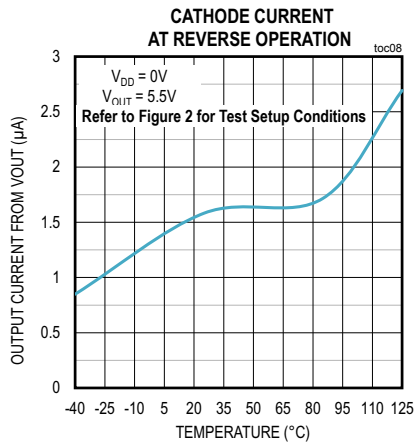

Test Setup

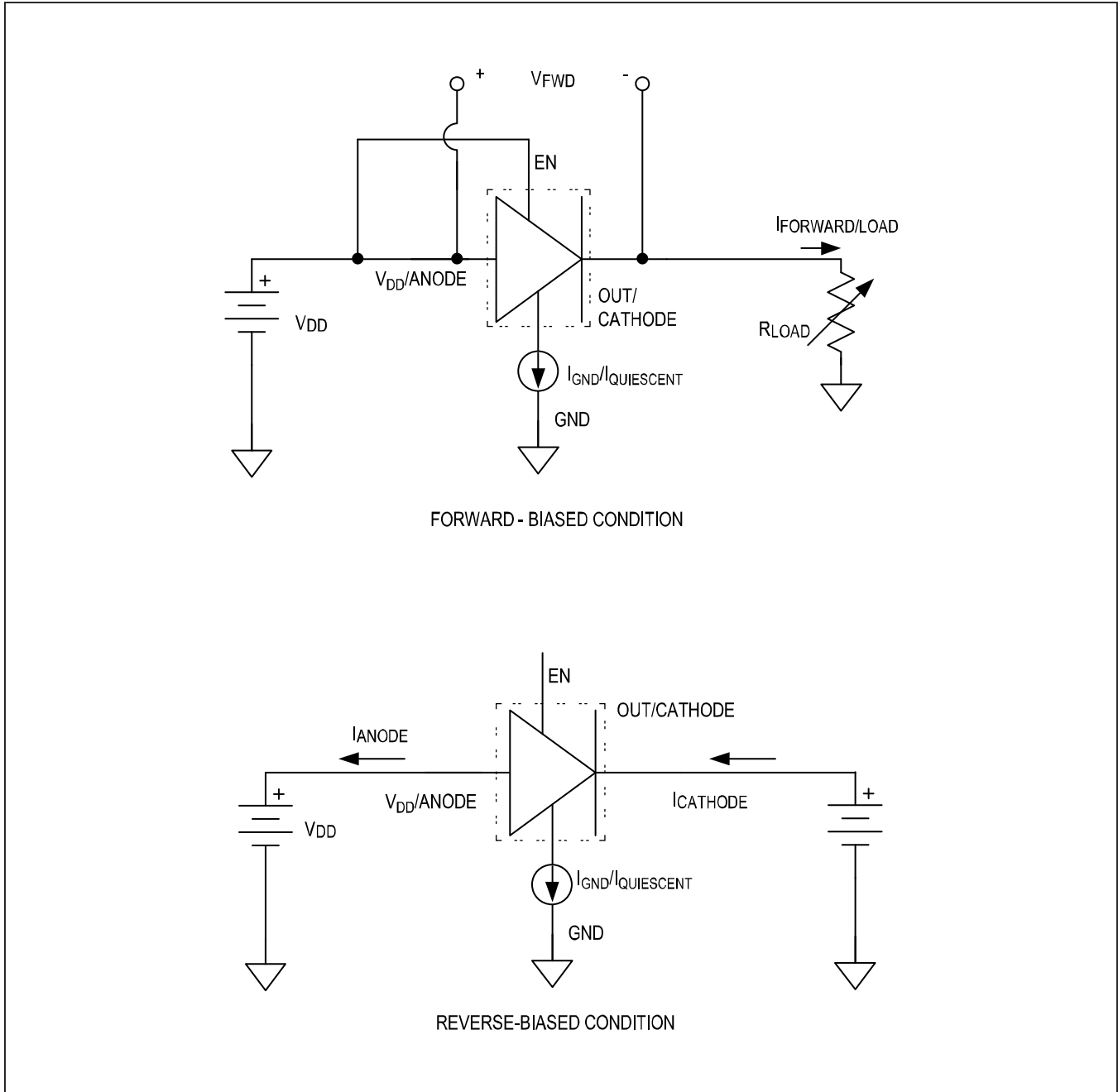

Pin Configurations

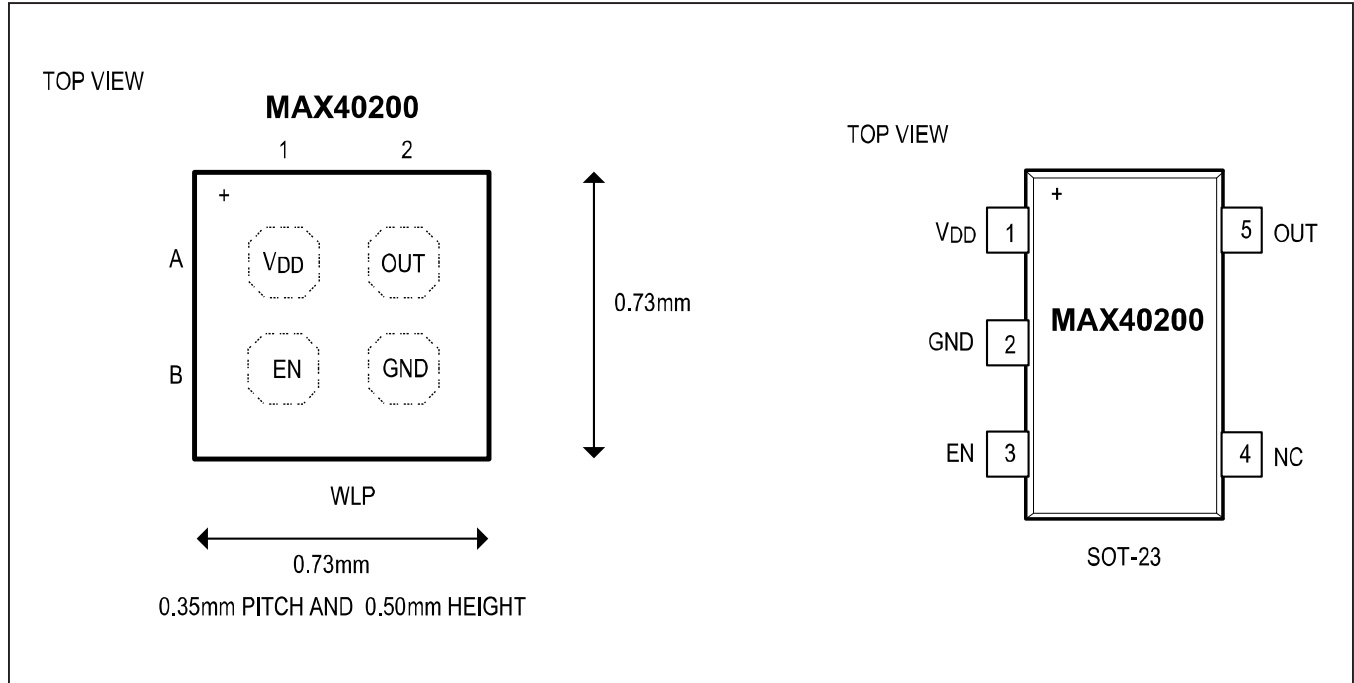

Pin Description

WLP	5 SOT-23	NAME	FUNCTION
A1	1	V _{DD}	Supply Input or Anode.
A2	5	OUT	Ideal Diode Output or Cathode.
B1	3	EN	Enable Input. Pull high to enable the device and pull low to disable the device. Active pullup.
B24	2	GND	Circuit Ground and Substrate Connection.
—	4	N.C.	No Connect. Internally not connected.

Detailed Description

The MAX40200 mimics a near-ideal diode. The device blocks reverse-voltages and passes current when forward-biased just as a normal diode. The improvements are that instead of a cut-in voltage around 500mV and a logarithmic voltage-current transfer curve, the MAX40200 has a near constant voltage drop independent of the magnitude of the forward current flowing through it. This voltage drop is around 45mV at 500mA of forward or load current.

The constant forward voltage drop significantly helps with supply regulation; a normal diode typically drops an additional 60mV for every 10 times change in current through it.

Similar to a normal diode, the MAX40200 also becomes resistive as the forward current exceeds the specified limit (see [Figure 1](#)). Unlike a normal diode, should the MAX40200 exceed the specified temperature, it will turn off in order to protect itself and the circuitry connected to it. Like a normal diode MAX40200 will turn-off when it is reverse biased. The turn-on and turn-off times for enable and disable responses are similar to those of forward and reverse bias conditions.

MAX40200 has an enable function feature. Unlike a normal diode the device can be turned off when not required. When turned off, it blocks voltages on either side to a maximum of 6V above ground. This feature allows MAX40200 to be used, to switch supply sources, or to control which sub-systems are to be powered up.

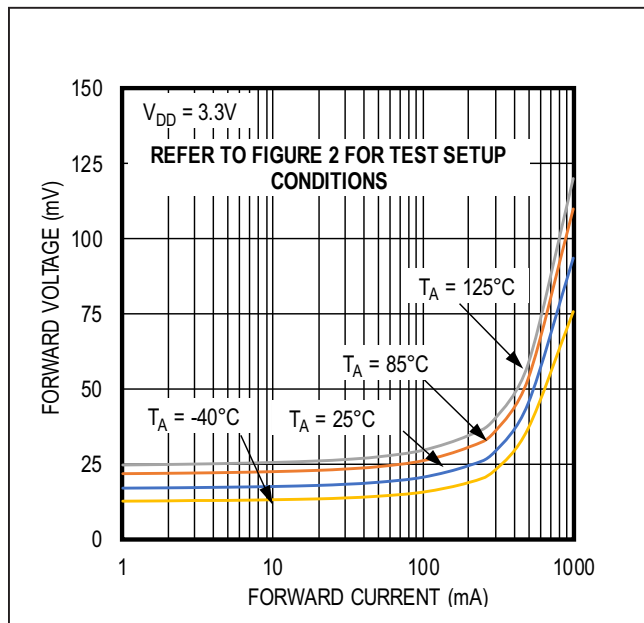

Figure 1. Forward Voltage vs. Forward Current (WLP)

It should be noted, however, that, unlike normal diodes, this “ideal diode” is not suited to rectifying AC. In applications where the supply is inductively coupled, conventional diodes should be used for the rectification part of the circuitry. MAX40200 is designed to be used in applications to switch between different DC sources.

Principle of Operation

The MAX40200 features an internal pMOSFET to pass the current from the V_{DD} input to the OUT output. The internal MOSFET is controlled by circuitry that:

- 1) Creates the 18mV constant forward drop when the MAX40200 is forward-biased.
- 2) Turns the MOSFET off when the part is reverse-biased.
- 3) Turns the MOSFET off if the enable input is pulled low.
- 4) Turns the device off when the device temperature exceeds the thermal protection threshold.

This control circuitry consumes 7 μ A typical current and this limits the rate at which the internal MOSFET can be turned on/off.

To ensure the control loop remains stable for all output current levels, there should always be a minimum of 0.33 μ F connected to the OUT output and likewise, a minimum of 0.33 μ F on the V_{DD} input.

These capacitors also improve the surge capability of power supply. In general for higher Output Capacitive Loads [e.g., $C_{OUT} = 10\mu\text{F}$], then C_{IN} should be kept to $C_{OUT}/10$ (μF) for optimum transient response.

Applications Information

The simplest application would be as shown in [Figure 2](#), where the battery has to be disconnected from the load when the wall-supply is connected. Often, the wall-supply can handle the additional losses of a normal diode, so it would use a regular diode to prevent battery power from flowing back into it.

The battery, on the other hand, benefits significantly by only losing 30mV when powering the load, thus increasing the battery life between charging cycles.

For systems that require more than the 500mA that the MAX40200 is specified for, it may be convenient to split the load up into various sections that could also benefit from the individual power enabling that the MAX40200’s Enable pins offer.

This also suggests that any integrated circuit without built-in power-down capability can have it added by powering it through a MAX40200.

This allows many parts to be used in portable and other power-sensitive products.

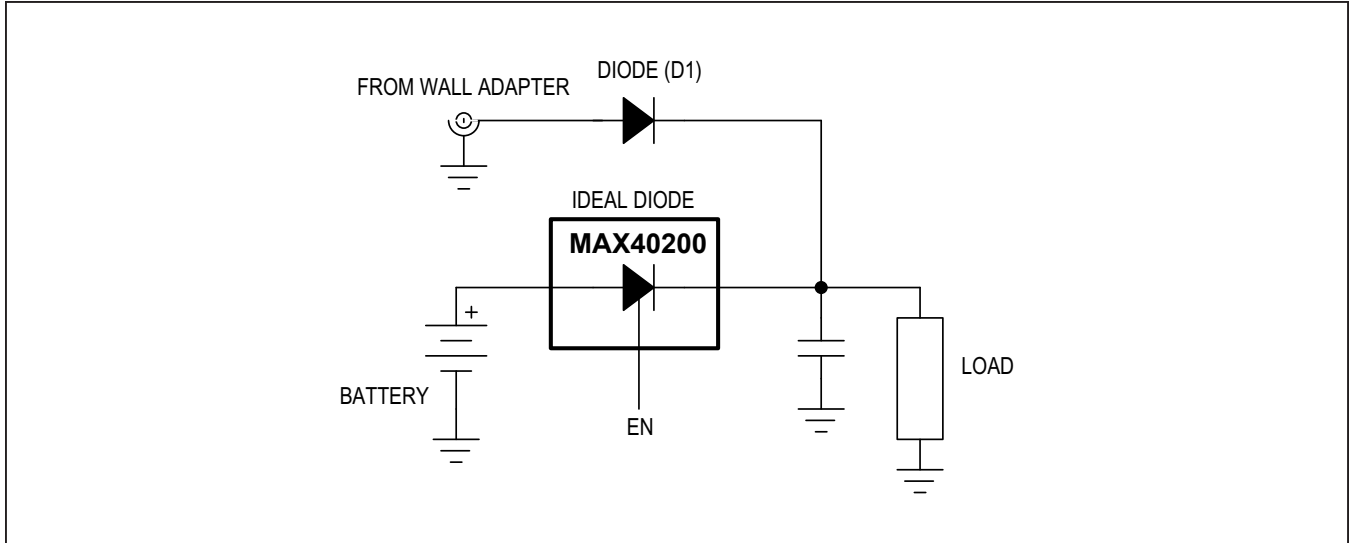

Figure 2. Diode ORing Circuit 1

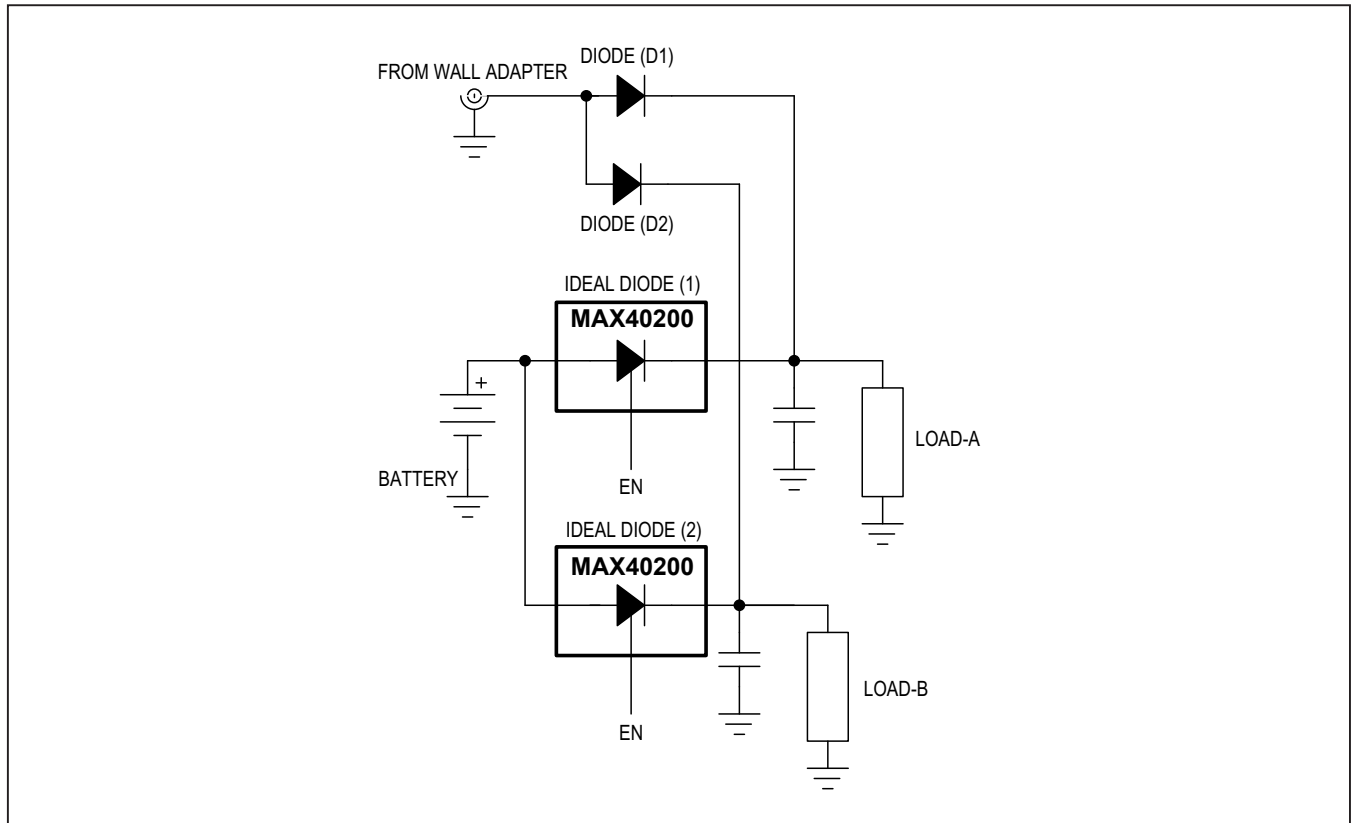

Figure 3. Diode ORing Circuit 2

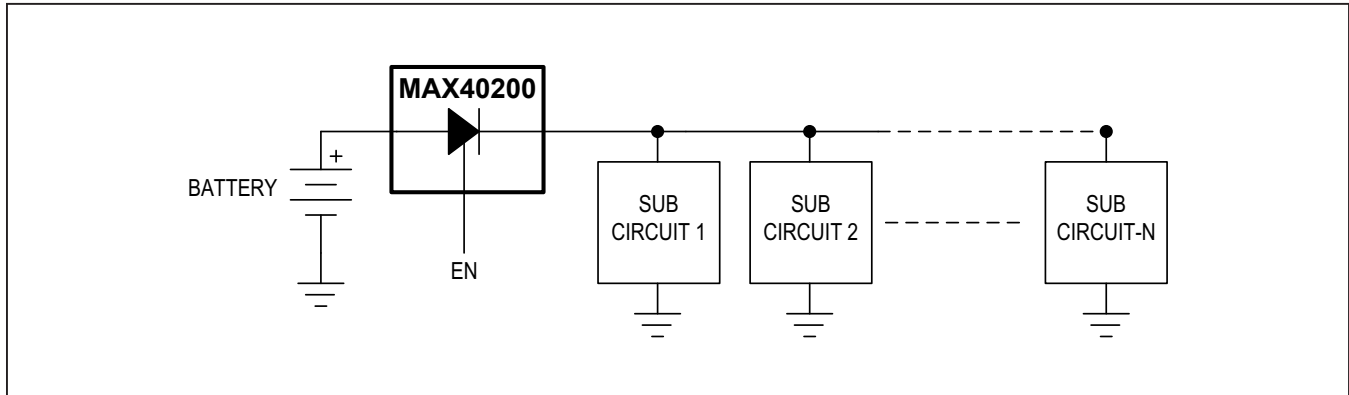

Figure 4. Typical Application Circuit

Thermal Performance and Power Dissipation Information

Although the device is guaranteed for $T_A = -40^\circ\text{C}$ to 125°C , care must be taken when using heavy loads (e.g., I_{FWD} above 500mA to 1A) where the forward current across the ideal diode is large. The forward voltage drop across the VDD and OUT pins increases linearly with forward current. The device's power dissipation is directly proportional to the voltage drop across the device.

The power dissipation is going to be the differential voltage (V_{FWD}) multiplied by the current passed by the device (I_{FWD}). The quiescent current of the device is negligible for these calculations. The ambient temperature is essentially the PCB temperature, since this is where all the heat is sunk to. Therefore, the parts temperature rise is $[V_{FWD} \times I_{FWD} \times \theta_{JA}] + T_A$, where T_A is the temperature of the board or ambient temperature. From this exercise, we observe that the internal temperature from power dissipation will be higher than the ambient temperature. The device has an internal thermal shutdown temperature of about $+154^\circ\text{C}$ and, typically, 12°C hysteresis.

For example:

WLP:

At 1A I_{FWD} , $T_A = 85^\circ\text{C}$. $V_{FWD} = 110\text{mV}$. Therefore, $P_{DIS} = 110\text{mW}$.

Package Derate Calculation:

For 85°C : Maximum Power Dissipation from the data sheet: $766\text{mW} - [(85 - 70) \times 9.58] = 622\text{mW}$. The device is within specification. Therefore, the junction temperature: $85^\circ\text{C} + (104.41^\circ\text{C/W} \times 0.110\text{W}) = 85^\circ\text{C} + 11.5^\circ\text{C} = 96.5^\circ\text{C}$

SOT-23 (Small Outline Transistor Package):

At 1A I_{FWD} , $T_A = 85^\circ\text{C}$. $V_{FWD} = 250\text{mV}$. Hence, $P_{DIS} = 250\text{mW}$.

Package Derate Calculation:

For 85°C : Maximum Power Dissipation from the data sheet: $312.6\text{mW} - [(85 - 70)^\circ\text{C} \times 3.9\text{mW}/^\circ\text{C}] = 254.1\text{mW}$. The device is very close to the power dissipation ratings provided in the absolute maximum specification.

Hence the device's junction temperature: $85^\circ\text{C} + (255.90^\circ\text{C/W} \times 0.2541\text{W}) = 85^\circ\text{C} + 65.02^\circ\text{C} = 150.02^\circ\text{C}$

As the above example shows, the thermal performance of the WLP exceeds the SOT package.

When the device's junction temperature rises to 154°C thermal trip is triggered, the thermal cycle for the WLP and SOT packages are shown in [Figure 5](#) and [Figure 6](#).

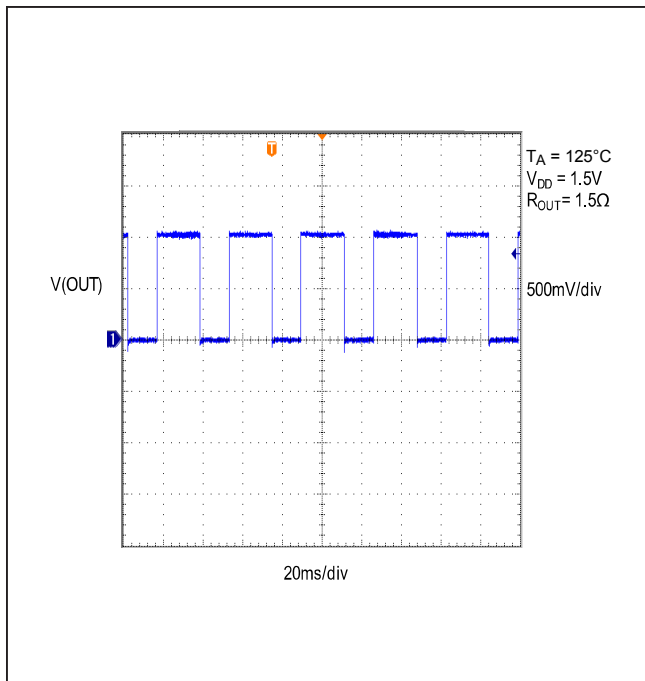

Figure 5. Thermal Protection (WLP)

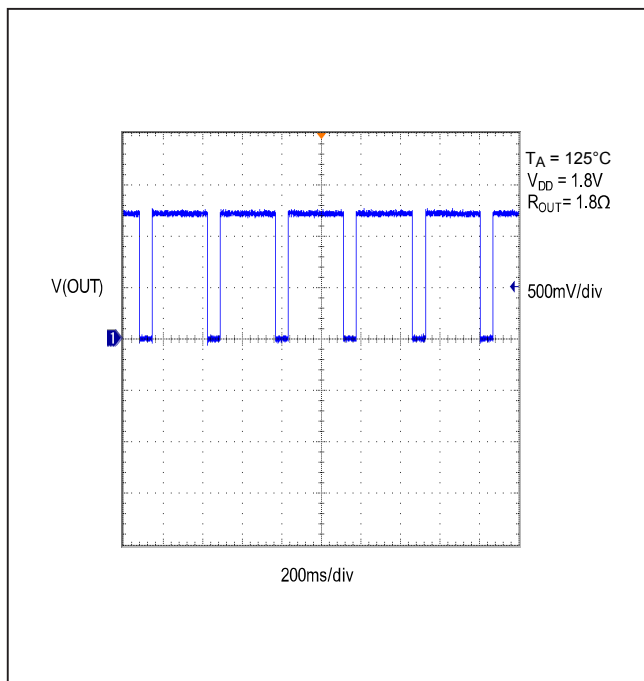

Figure 6. Thermal Protection (SOT)

MAX40200

Ultra-Tiny Micropower, 1A Ideal Diode with Ultra-Low Voltage Drop

Ordering Information

PART	TEMP RANGE	PIN-PACKAGE
MAX40200ANS+	-40°C to +125°C	4 WLP
MAX40200AUK+	-40°C to +125°C	5 SOT23

+Denotes a lead(Pb)-free/RoHS-compliant package.

Chip Information

PROCESS: BiCMOS

Package Information

For the latest package outline information and land patterns (footprints), go to www.maximintegrated.com/packages. Note that a "+", "#", or "-" in the package code indicates RoHS status only. Package drawings may show a different suffix character, but the drawing pertains to the package regardless of RoHS status.

PACKAGE TYPE	PACKAGE CODE	OUTLINE NO.	LAND PATTERN NO.
4 WLP	N40C0+1	21-100103	Refer to App Note 1891
5 SOT23	U5+1	21-0057	90-0174

Revision History

REVISION NUMBER	REVISION DATE	DESCRIPTION	PAGES CHANGED
0	12/16	Initial release	—
1	4/17	Updated <i>Electrical Characteristics</i> table, correct typos in <i>Applications</i> and <i>Detailed Description</i> sections, added TOC, and removed future product asterisk from SOT version	1–3, 9, 13

For pricing, delivery, and ordering information, please contact Maxim Direct at 1-888-629-4642, or visit Maxim Integrated's website at www.maximintegrated.com.

Maxim Integrated cannot assume responsibility for use of any circuitry other than circuitry entirely embodied in a Maxim Integrated product. No circuit patent licenses are implied. Maxim Integrated reserves the right to change the circuitry and specifications without notice at any time. The parametric values (min and max limits) shown in the *Electrical Characteristics* table are guaranteed. Other parametric values quoted in this data sheet are provided for guidance.