



Low Cost Universal AC Input LED Circuit

ON Semiconductor

Application	Input Voltage	Topology	Output Power	Input Power
LED Lighting, AC	80 to 280 V _{AC}	Chopper	0.74 to 0.85 W	1.5 to 1.8 W

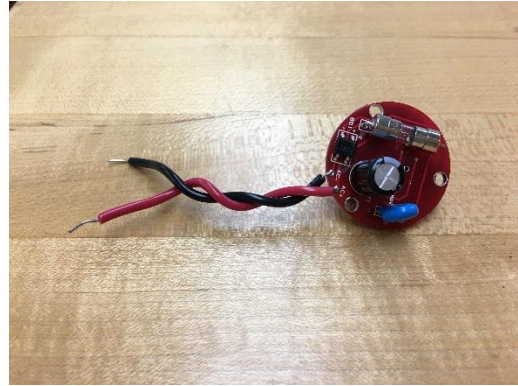
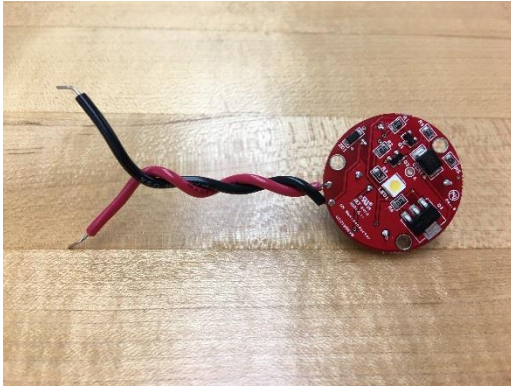

Figure 1 – Universal Input Chopper Circuit Top/ Bottom View

Key Features

- Operates from 80 to 280 V_{AC} with just one 48 V LED required
- The LED receives a constant current independent of input voltage
- Extremely low BOM cost

Schematic

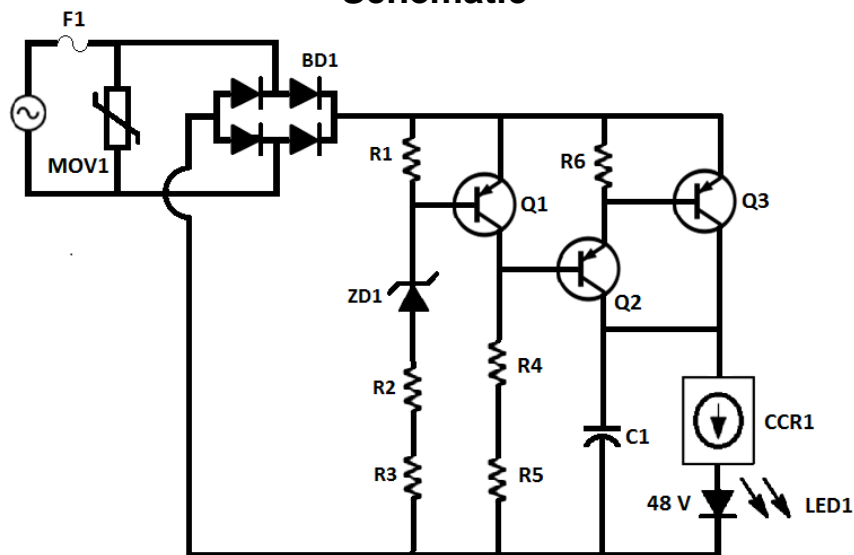

Figure 2 – Universal Input Chopper Schematic.

Circuit Operation

This circuit is a simple, low parts count, chopper topology. It is designed to safely operate with input voltages varying from 80 V_{AC} to 280 V_{AC}. ON Semiconductor CCRs are used to provide constant LED current and to protect LEDs from over-voltage conditions.

This circuit uses active switching to change how the load is being driven. The LED load will either be driven from the capacitor, C1, discharging, or directly from the AC source. The CCR ensures a constant current through the LED throughout all modes of operation. The switching point of the circuit may be changed by varying the resistor, R1. Changing this switching point will change the amount of time the capacitor is charging. If a higher power output is desired a higher current CCR can be used and the switching point will need to be changed. A metal oxide varistor and fuse are designed into the circuit for surge protection purposes.

Universal Input Chopper Attributes vs. Input Voltages

We created the following plots in order to show how the universal input chopper circuit performs over a wide range of input voltages. We varied the input voltage from 80 V_{AC} up to 280 V_{AC}. Figure 3 shows that the output current and the output power being supplied to the LED remains very constant. This leads to a constant and predictable light output of the LED. Figure 4 plots the power factor and efficiency of the driver vs. input voltage. Again, we varied the input voltage from 80 V_{AC} to 280 V_{AC}. The efficiency remains fairly constant at 50%. This is because our input and output power levels do not vary that much, as seen in figure 3. The power factor, however, does decrease at the higher input voltages. This decrease in power factor arises from a decrease in the amount of time we are conducting from the AC source at the higher voltages. Our LED driver meets all of the power factor requirements in the U.S. because it draws less than 5 W of power.

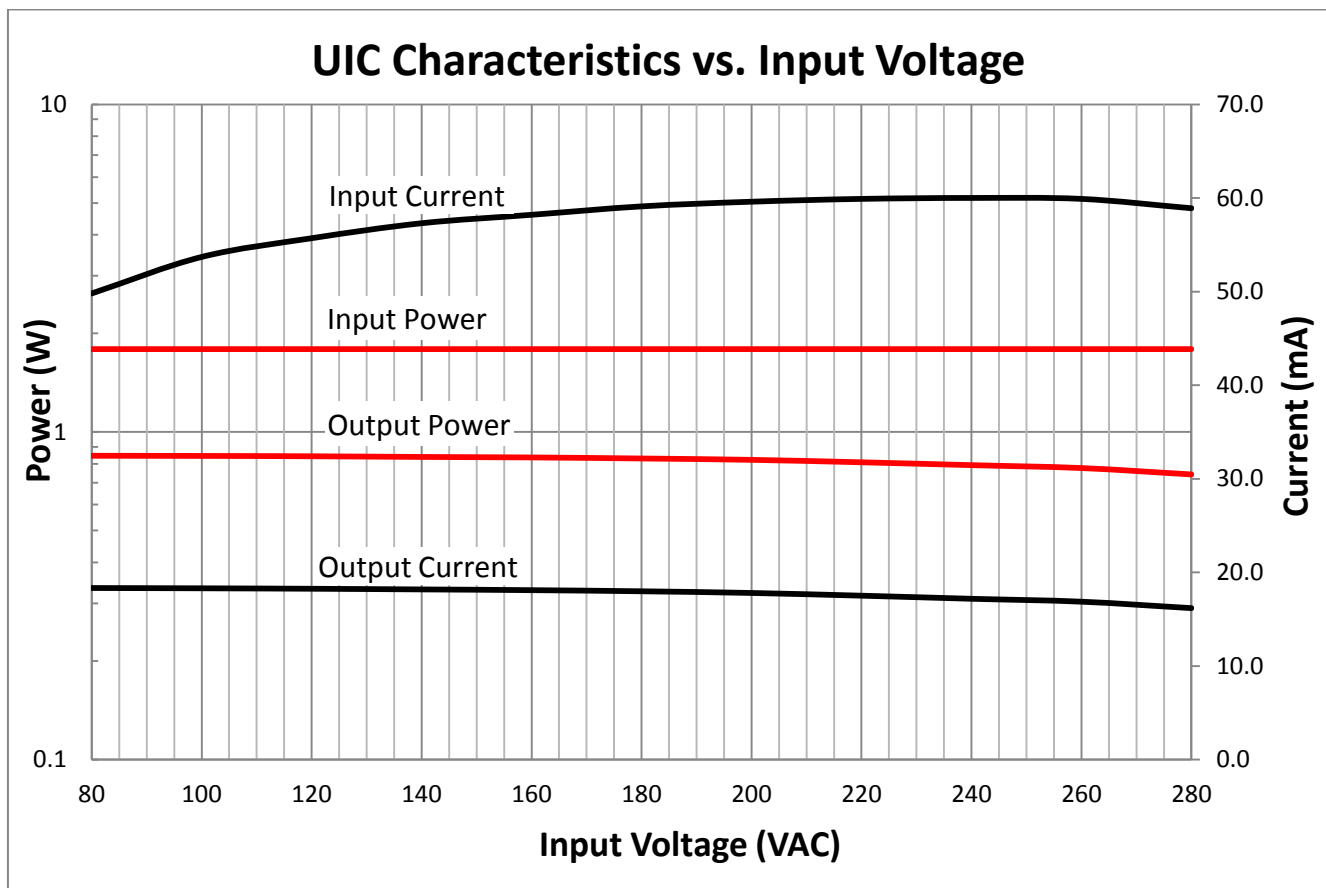

Figure 3 – The plot above shows the constant current, power nature of the LED driver.

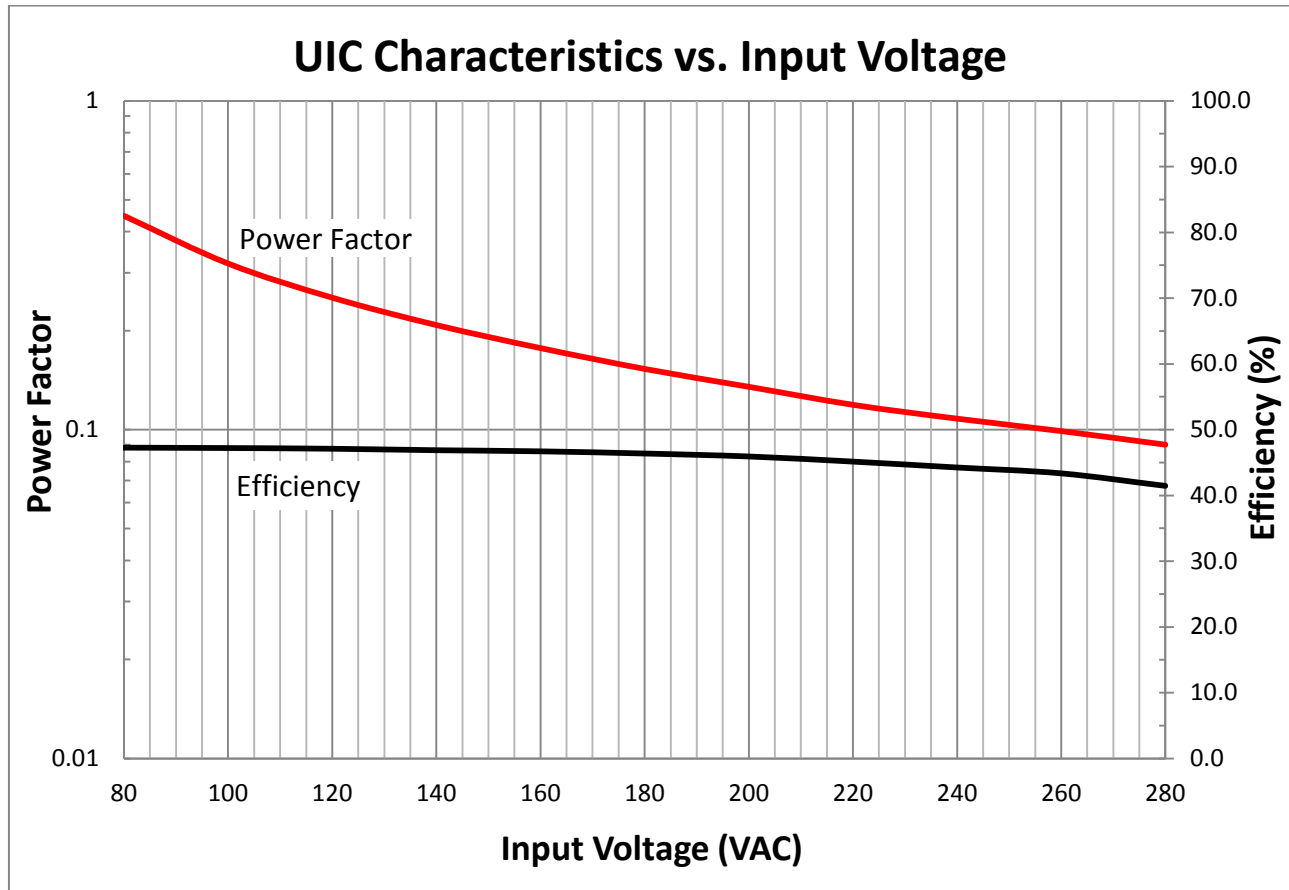

Figure 4 – The plot above shows how the power factor and the efficiency of the driver varies with the input voltage.

Universal Input Chopper Thermal Considerations

When it comes to designing circuits and PCB's one must take into account the amount of power that will be dissipating on each part. With an excessive amount of power on a part we will observe an excessive amount of heat on that part. The biggest challenge is creating an aesthetically pleasing PCB that embodies a small form factor, all while allowing proper heat dissipation. Because of our expertise in circuit design we know that the majority of the power in this circuit will be dissipated over the CCR at low input voltages and over Q3 at higher input voltages. It is critical to add heat sinking to the cathode of the CCR and also the collector of Q3.

By using a FLIR camera we are able to study how our circuit/PCB performs thermally over different input voltages. We are also able to verify our logic of where the heat should be dissipating for the given input voltage. Figure 5 shows the universal input chopper operating with an input voltage of 120 V_{AC}. The hot spot in the image is the CCR, peaking at approximately 90°C. At the lower input voltages the CCR and LED are being driven by C1 discharging for a longer period of time. There is a large voltage across the CCR, causing it to heat up. Our thermal images verify to us that the CCR is still safely operating.

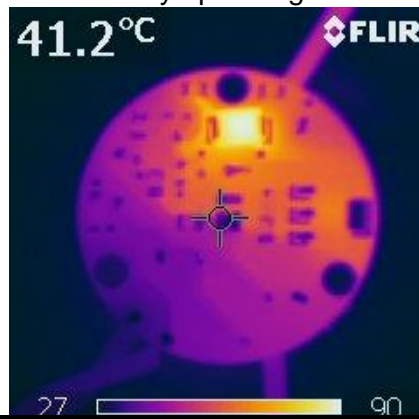

Figure 5 – The image above shows the heat dissipation of the driver operating at 120 V_{AC}.

We next moved on to a higher input voltage, 240 V_{AC}. Figure 6 below shows the thermal characteristics of the universal input chopper now. Please notice how the CCR has now cooled off and the majority of the heat dissipation is now across Q3. The capacitor C1 is not driving the CCR and LED for an extended period of time. We get a voltage built up across the emitter-collector junction of Q3, causing this BJT to dissipate heat, peaking at approximately 80°C. These thermal images again assure us that the circuit/PCB are operating in a safe region.

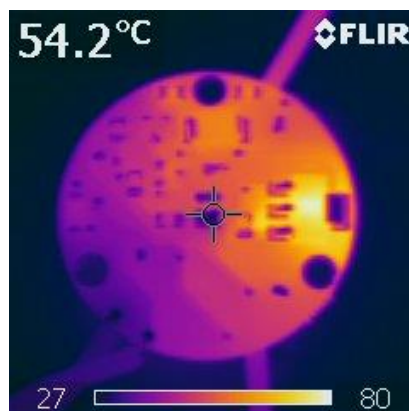

Figure 6 – The image above shows the heat dissipation of the driver operating at 240 V_{AC}.

Circuit Performance Data

Input Voltage (VAC)	PF	Input Current (mA)	Input Power (W)	Output Power (W)	Output Current (mA)	Efficiency (%)
80	0.447	49.8	1.79	0.846	18.3	47.3
100	0.320	53.7	1.68	0.845	18.3	50.3
120	0.252	55.7	1.70	0.843	18.3	49.6
140	0.208	57.3	1.66	0.839	18.2	50.5
160	0.177	58.2	1.66	0.836	18.1	50.4
180	0.153	59.1	1.58	0.830	18.0	52.5
200	0.135	59.6	1.62	0.822	17.8	50.7
220	0.119	59.9	1.60	0.808	17.5	50.5
240	0.108	60.0	1.56	0.792	17.2	50.8
260	0.099	59.9	1.59	0.776	16.9	48.8
280	0.090	58.9	1.50	0.742	16.2	49.5

Bill of Materials

Designator	Quantity	Description	Value	Tolerance	Footprint	Manufacturer	Manufacturer Part Number	Substitution Allowed
R1	1	Resistor SMD	33k Ω , 1/8th W	1%	0805	Any	Any	Yes
R2-R6	5	Resistor SMD	510k Ω , 1/8th W	1%	0805	Any	Any	Yes
C1	1	Capacitor Aluminum TH	10 μ F, 160 V	20%	TH	Chemi-Con	EKXE161ELL100MH B5D	Yes
Q1	1	PNP Bipolar Transistor SMD	N/A	N/A	SOT-23	ON Semiconductor	MMBT3906LT1G	No
Q2	1	PNP Bipolar Transistor SMD	N/A	N/A	SOT-23	ON Semiconductor	MMBT6520LT1G	No
Q3	1	NPN Bipolar Transistor SMD	N/A	N/A	SOT-223	ON Semiconductor	PZTA96S	No
ZD1	1	Zener Diode SMD	91 Vz	N/A	SOD-123	ON Semiconductor	MMSZ5270B	No
CCR1	1	Constant Current Regulator SMD	120V, 20mA	15%	SMB	ON Semiconductor	NSIC2020JB	No
BD1	1	Bridge Rectifier	N/A	N/A	DIP4	ON Semiconductor	DBB08G	Yes
F1	1	Fuse	1A, 350 VAC	N/A	TH	Bel Fuse Inc.	3JQ 1-R	Yes
MOV1	1	Varistor	423V, 1.2kA	N/A	TH	Bourns Inc.	MOV-07D471KTR	Yes
LED1	1	SMD LED	48V	N/A	2-SMD	Phillips Lumileds	L135- 50800CHV00001	No

© 2016 ON Semiconductor.

Disclaimer: ON Semiconductor is providing this design note "AS IS" and does not assume any liability arising from its use; nor does ON Semiconductor convey any license to its or any third party's intellectual property rights. This document is provided only to assist customers in evaluation of the referenced circuit implementation and the recipient assumes all liability and risk associated with its use, including, but not limited to, compliance with all regulatory standards. ON Semiconductor may change any of its products at any time, without notice.

Design note created by Andrew Niles and Andrew Stemple