

# IRLML6402

HEXFET® Power MOSFET

- Ultra Low On-Resistance
- P-Channel MOSFET
- SOT-23 Footprint
- Low Profile (<1.1mm)
- Available in Tape and Reel
- Fast Switching

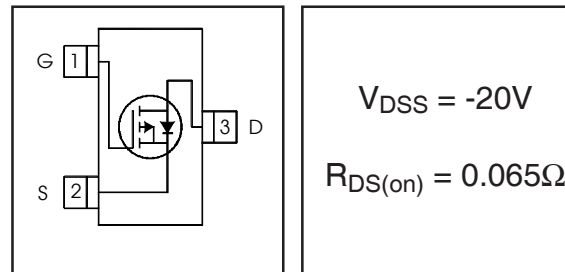

## Description

These P-Channel MOSFETs from International Rectifier utilize advanced processing techniques to achieve extremely low on-resistance per silicon area. This benefit, combined with the fast switching speed and ruggedized device design that HEXFET® power MOSFETs are well known for, provides the designer with an extremely efficient and reliable device for use in battery and load management.

A thermally enhanced large pad leadframe has been incorporated into the standard SOT-23 package to produce a HEXFET Power MOSFET with the industry's smallest footprint. This package, dubbed the Micro3™, is ideal for applications where printed circuit board space is at a premium. The low profile (<1.1mm) of the Micro3 allows it to fit easily into extremely thin application environments such as portable electronics and PCMCIA cards. The thermal resistance and power dissipation are the best available.

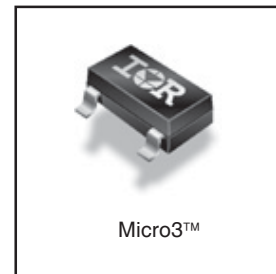

## Absolute Maximum Ratings

	Parameter	Max.	Units
$V_{DS}$	Drain- Source Voltage	-20	V
$I_D @ T_A = 25^\circ C$	Continuous Drain Current, $V_{GS} @ -4.5V$	-3.7	A
$I_D @ T_A = 70^\circ C$	Continuous Drain Current, $V_{GS} @ -4.5V$	-2.2	
$I_{DM}$	Pulsed Drain Current ①	-22	
$P_D @ T_A = 25^\circ C$	Power Dissipation	1.3	W
$P_D @ T_A = 70^\circ C$	Power Dissipation	0.8	
	Linear Derating Factor	0.01	W/°C
$E_{AS}$	Single Pulse Avalanche Energy④	11	mJ
$V_{GS}$	Gate-to-Source Voltage	$\pm 12$	V
$T_J, T_{STG}$	Junction and Storage Temperature Range	-55 to + 150	°C

## Thermal Resistance

	Parameter	Typ.	Max.	Units
$R_{\theta JA}$	Maximum Junction-to-Ambient③	75	100	°C/W

## Electrical Characteristics @ T<sub>J</sub> = 25°C (unless otherwise specified)

	Parameter	Min.	Typ.	Max.	Units	Conditions
V <sub>(BR)DSS</sub>	Drain-to-Source Breakdown Voltage	-20	—	—	V	V <sub>GS</sub> = 0V, I <sub>D</sub> = -250μA
ΔV <sub>(BR)DSS</sub> /ΔT <sub>J</sub>	Breakdown Voltage Temp. Coefficient	—	-0.009	—	V/°C	Reference to 25°C, I <sub>D</sub> = -1mA ②
R <sub>DS(on)</sub>	Static Drain-to-Source On-Resistance	—	0.050	0.065	Ω	V <sub>GS</sub> = -4.5V, I <sub>D</sub> = -3.7A ②
		—	0.080	0.135		V <sub>GS</sub> = -2.5V, I <sub>D</sub> = -3.1A ②
V <sub>GS(th)</sub>	Gate Threshold Voltage	-0.40	-0.55	-1.2	V	V <sub>DS</sub> = V <sub>GS</sub> , I <sub>D</sub> = -250μA
g <sub>fs</sub>	Forward Transconductance	6.0	—	—	S	V <sub>DS</sub> = -10V, I <sub>D</sub> = -3.7A ②
I <sub>DSS</sub>	Drain-to-Source Leakage Current	—	—	-1.0	μA	V <sub>DS</sub> = -20V, V <sub>GS</sub> = 0V
		—	—	-25		V <sub>DS</sub> = -20V, V <sub>GS</sub> = 0V, T <sub>J</sub> = 70°C
I <sub>GSS</sub>	Gate-to-Source Forward Leakage	—	—	-100	nA	V <sub>GS</sub> = -12V
	Gate-to-Source Reverse Leakage	—	—	100		V <sub>GS</sub> = 12V
Q <sub>g</sub>	Total Gate Charge	—	8.0	12	nC	I <sub>D</sub> = -3.7A
Q <sub>gs</sub>	Gate-to-Source Charge	—	1.2	1.8		V <sub>DS</sub> = -10V
Q <sub>gd</sub>	Gate-to-Drain ("Miller") Charge	—	2.8	4.2		V <sub>GS</sub> = -5.0V ②
t <sub>d(on)</sub>	Turn-On Delay Time	—	350	—	ns	V <sub>DD</sub> = -10V
t <sub>r</sub>	Rise Time	—	48	—		I <sub>D</sub> = -3.7A
t <sub>d(off)</sub>	Turn-Off Delay Time	—	588	—		R <sub>G</sub> = 89Ω
t <sub>f</sub>	Fall Time	—	381	—		R <sub>D</sub> = 2.7Ω
C <sub>iss</sub>	Input Capacitance	—	633	—	pF	V <sub>GS</sub> = 0V
C <sub>oss</sub>	Output Capacitance	—	145	—		V <sub>DS</sub> = -10V
C <sub>rss</sub>	Reverse Transfer Capacitance	—	110	—		f = 1.0MHz

## Source-Drain Ratings and Characteristics

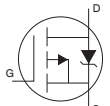
	Parameter	Min.	Typ.	Max.	Units	Conditions
I <sub>S</sub>	Continuous Source Current (Body Diode)	—	—	-1.3	A	MOSFET symbol showing the integral reverse p-n junction diode. 
I <sub>SM</sub>	Pulsed Source Current (Body Diode) ①	—	—	-22		
V <sub>SD</sub>	Diode Forward Voltage	—	—	-1.2	V	T <sub>J</sub> = 25°C, I <sub>S</sub> = -1.0A, V <sub>GS</sub> = 0V ②
t <sub>rr</sub>	Reverse Recovery Time	—	29	43	ns	T <sub>J</sub> = 25°C, I <sub>F</sub> = -1.0A
Q <sub>rr</sub>	Reverse Recovery Charge	—	11	17	nC	di/dt = -100A/μs ②

### Notes:

- ① Repetitive rating; pulse width limited by max. junction temperature.
- ② Pulse width ≤ 400μs; duty cycle ≤ 2%.
- ③ Surface mounted on 1" square single layer 1oz. copper FR4 board, steady state.
- ④ Starting T<sub>J</sub> = 25°C, L = 1.65mH  
R<sub>G</sub> = 25Ω, I<sub>AS</sub> = -3.7A.

\*\* For recommended footprint and soldering techniques refer to application note #AN-994.

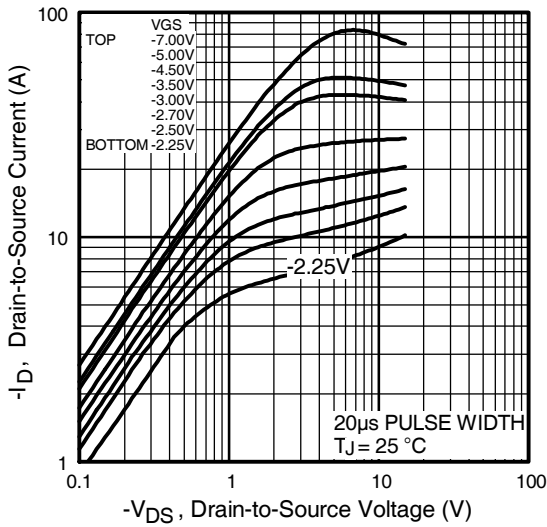

**Fig 1.** Typical Output Characteristics

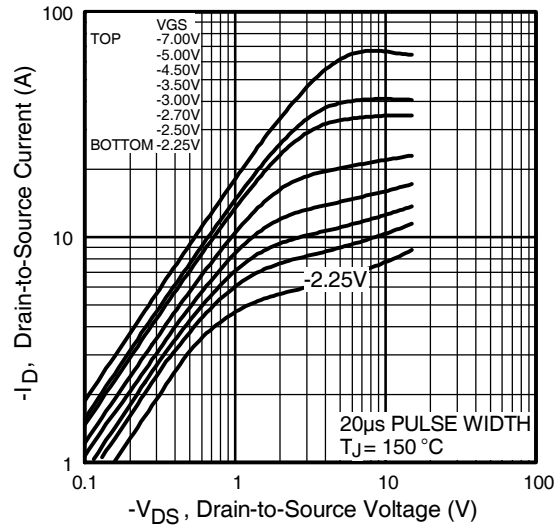

**Fig 2.** Typical Output Characteristics

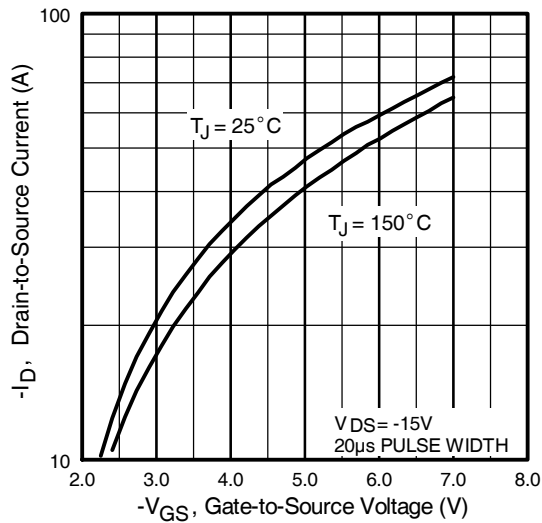

**Fig 3.** Typical Transfer Characteristics

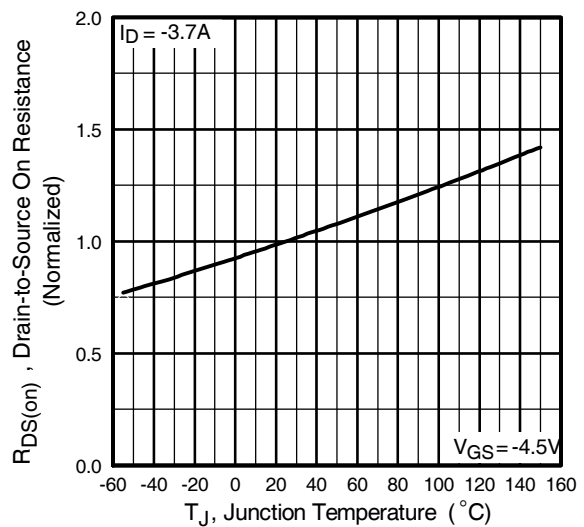

**Fig 4.** Normalized On-Resistance Vs. Temperature

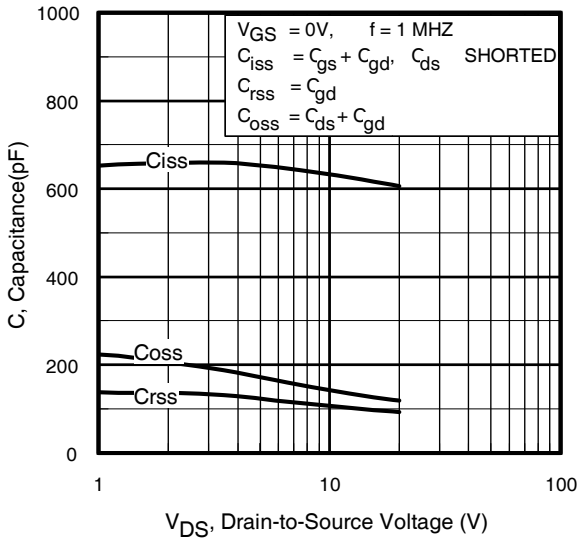

**Fig 5.** Typical Capacitance Vs. Drain-to-Source Voltage

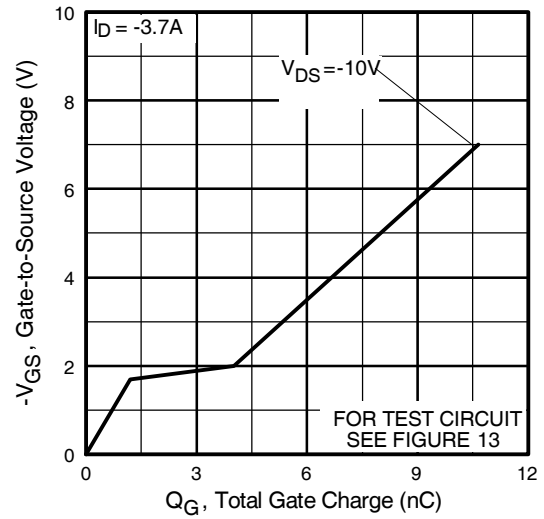

**Fig 6.** Typical Gate Charge Vs. Gate-to-Source Voltage

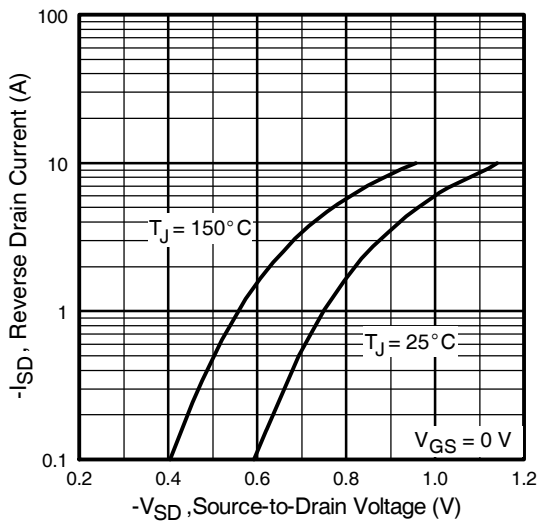

**Fig 7.** Typical Source-Drain Diode Forward Voltage

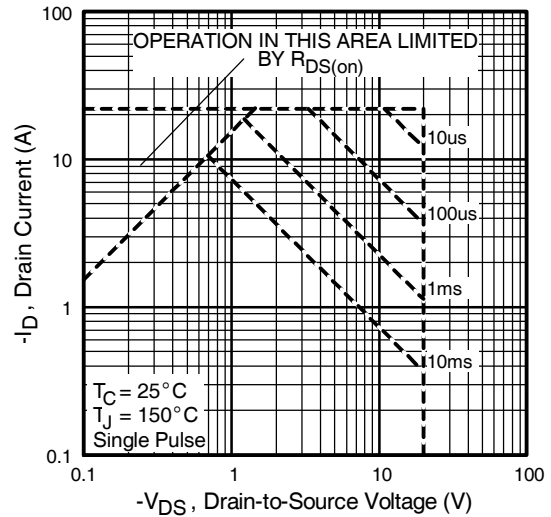

**Fig 8.** Maximum Safe Operating Area

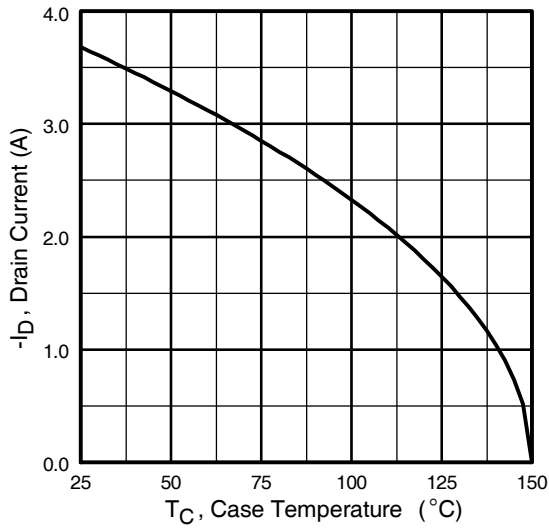

**Fig 9.** Maximum Drain Current Vs. Case Temperature

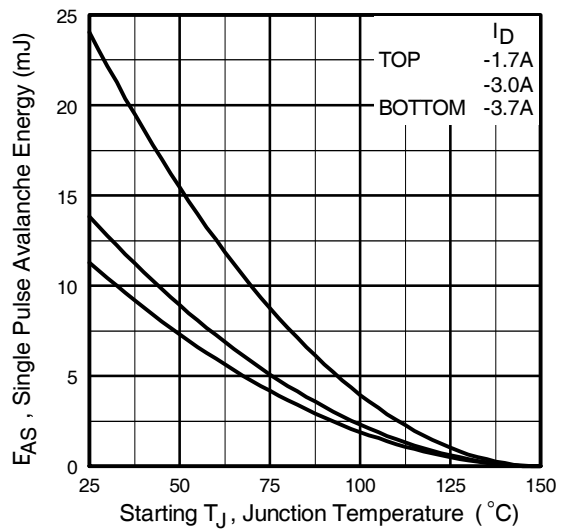

**Fig 10.** Maximum Avalanche Energy Vs. Drain Current

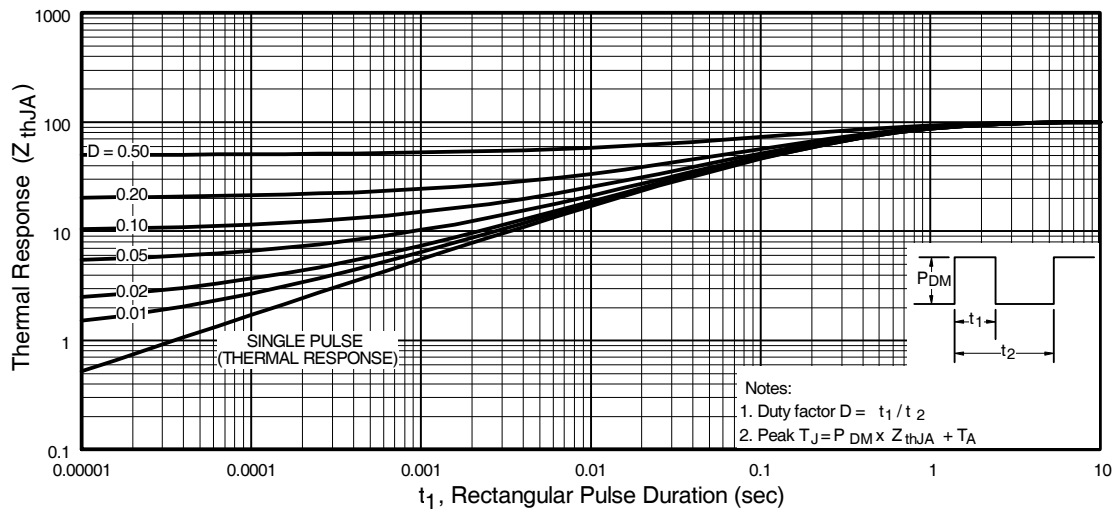

**Fig 11.** Maximum Effective Transient Thermal Impedance, Junction-to-Ambient

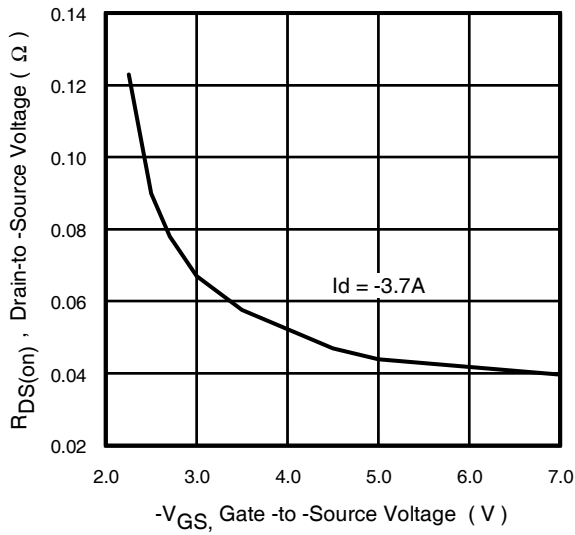

**Fig 12.** Typical On-Resistance Vs. Gate Voltage

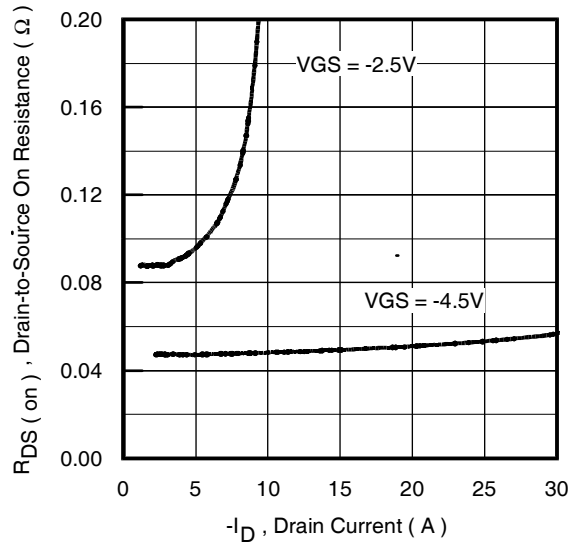

**Fig 13.** Typical On-Resistance Vs. Drain Current

## Micro3 (SOT-23) (Lead-Free) Package Outline

Dimensions are shown in millimeters (inches)

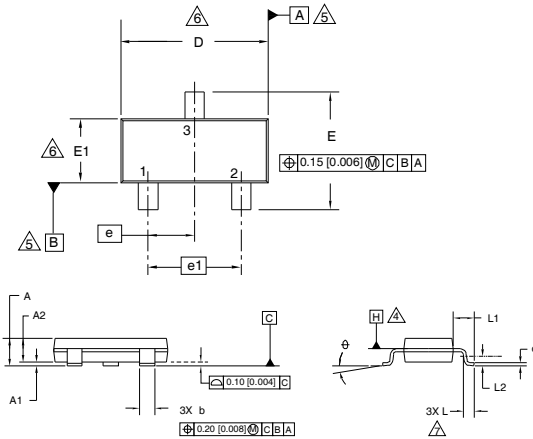

DIMENSIONS				
SYMBOL	MILLIMETERS		INCHES	
	MIN	MAX	MIN	MAX
A	0.89	1.12	0.035	0.044
A1	0.01	0.10	0.0004	0.004
A2	0.88	1.02	0.035	0.040
b	0.30	0.50	0.012	0.020
c	0.08	0.20	0.003	0.008
D	2.80	3.04	0.110	0.120
E	2.10	2.64	0.083	0.104
E1	1.20	1.40	0.047	0.055
e	0.95	BSC	0.037	BSC
e1	1.90	BSC	0.075	BSC
L	0.40	0.60	0.016	0.024
L1	0.54	REF	0.021	REF
L2	0.25	BSC	0.010	BSC
⊕	0	8	0	8

### Recommended Footprint

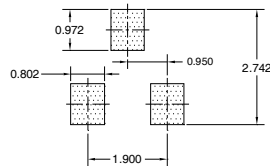

### NOTES:

1. DIMENSIONING & TOLERANCING PER ANSI Y14.5M-1994
2. DIMENSIONS ARE SHOWN IN MILLIMETERS (INCHES)
3. CONTROLLING DIMENSION: MILLIMETER
4. DATUM PLANE H IS LOCATED AT THE MOLD PARTING LINE
5. DATUM A AND B TO BE DETERMINED AT DATUM PLANE H
6. DIMENSIONS D AND E1 ARE MEASURED AT DATUM PLANE H. DIMENSIONS DOES NOT INCLUDE MOLD PROTRUSIONS OR INTERLEAD FLASH. MOLD PROTRUSIONS OR INTERLEAD FLASH SHALL NOT EXCEED 0.25 MM (0.010 INCH) PER SIDE.
7. DIMENSION L IS THE LEAD LENGTH FOR SOLDERING TO A SUBSTRATE.
8. OUTLINE CONFORMS TO JEDEC OUTLINE TO-236 AB.

## Micro3 (SOT-23 / TO-236AB) Part Marking Information

### Micro3 / SOT-23 Package Marking

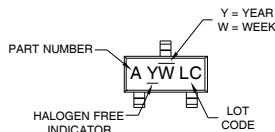

### PART NUMBER CODE REFERENCE:

- A = IRLML2402
- B = IRLML2803
- C = IRLML2402
- D = IRLML5103
- E = IRLML6402
- F = IRLML6401
- G = IRLML2502
- H = IRLML5203

Note: A line above the work week (as shown here) indicates Lead-free

W = (1-26) IF PRECEDED BY LAST DIGIT OF CALENDAR YEAR

YEAR	Y	WORK WEEK	W
2001	1	01	A
2002	2	02	B
2003	3	03	C
2004	4	04	D
2005	5		
2006	6		
2007	7		
2008	8		
2009	9		
2010	0	24	X
		25	Y
		26	Z

W = (27-52) IF PRECEDED BY A LETTER

YEAR	Y	WORK WEEK	W
2001	A	27	A
2002	B	28	B
2003	C	29	C
2004	D	30	D
2005	E		
2006	F		
2007	G		
2008	H		
2009	J		
2010	K	50	X
		51	Y
		52	Z

Note: For the most current drawing please refer to IR website at <http://www.irf.com/package>

# IRLML6402

International  
**IR** Rectifier

## Micro3™(SOT-23/TO-263AB) Tape & Reel Information

Dimensions are shown in millimeters (inches)

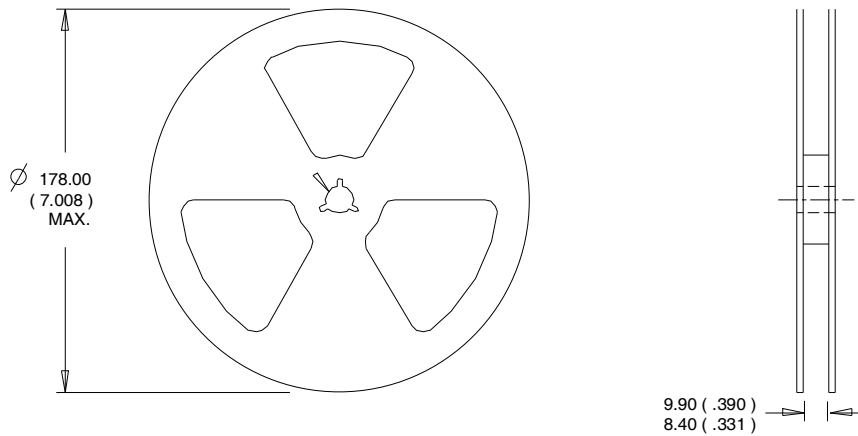
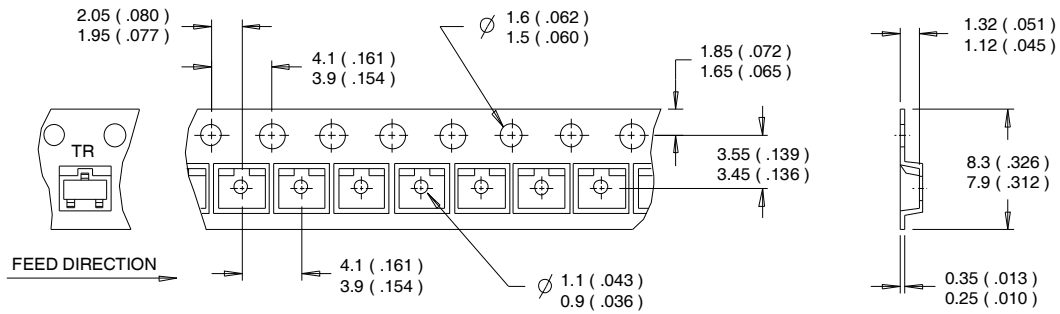

- NOTES:
1. CONTROLLING DIMENSION : MILLIMETER.
  2. OUTLINE CONFORMS TO EIA-481 & EIA-541.

Data and specifications subject to change without notice.

International  
**IR** Rectifier

**IR WORLD HEADQUARTERS:** 101N.Sepulveda Blvd, El Segundo, California 90245, USA Tel: (310) 252-7105  
TAC Fax: (310) 252-7903

Visit us at [www.irf.com](http://www.irf.com) for sales contact information. 12/2011