



CYALKIT-E03

Solar-Powered BLE Sensor Beacon 5 Pack Kit Guide

Doc. No. 002-12543 Rev. *A

Cypress Semiconductor
198 Champion Court
San Jose, CA 95134-1709
www.cypress.com

© Cypress Semiconductor Corporation, 2016-2017. This document is the property of Cypress Semiconductor Corporation and its subsidiaries, including Spansion LLC (“Cypress”). This document, including any software or firmware included or referenced in this document (“Software”), is owned by Cypress under the intellectual property laws and treaties of the United States and other countries worldwide. Cypress reserves all rights under such laws and treaties and does not, except as specifically stated in this paragraph, grant any license under its patents, copyrights, trademarks, or other intellectual property rights. If the Software is not accompanied by a license agreement and you do not otherwise have a written agreement with Cypress governing the use of the Software, then Cypress hereby grants you a personal, non-exclusive, nontransferable license (without the right to sublicense) (1) under its copyright rights in the Software (a) for Software provided in source code form, to modify and reproduce the Software solely for use with Cypress hardware products, only internally within your organization, and (b) to distribute the Software in binary code form externally to end users (either directly or indirectly through resellers and distributors), solely for use on Cypress hardware product units, and (2) under those claims of Cypress’s patents that are infringed by the Software (as provided by Cypress, unmodified) to make, use, distribute, and import the Software solely for use with Cypress hardware products. Any other use, reproduction, modification, translation, or compilation of the Software is prohibited.

TO THE EXTENT PERMITTED BY APPLICABLE LAW, CYPRESS MAKES NO WARRANTY OF ANY KIND, EXPRESS OR IMPLIED, WITH REGARD TO THIS DOCUMENT OR ANY SOFTWARE OR ACCOMPANYING HARDWARE, INCLUDING, BUT NOT LIMITED TO, THE IMPLIED WARRANTIES OF MERCHANTABILITY AND FITNESS FOR A PARTICULAR PURPOSE. To the extent permitted by applicable law, Cypress reserves the right to make changes to this document without further notice. Cypress does not assume any liability arising out of the application or use of any product or circuit described in this document. Any information provided in this document, including any sample design information or programming code, is provided only for reference purposes. It is the responsibility of the user of this document to properly design, program, and test the functionality and safety of any application made of this information and any resulting product. Cypress products are not designed, intended, or authorized for use as critical components in systems designed or intended for the operation of weapons, weapons systems, nuclear installations, life-support devices or systems, other medical devices or systems (including resuscitation equipment and surgical implants), pollution control or hazardous substances management, or other uses where the failure of the device or system could cause personal injury, death, or property damage (“Unintended Uses”). A critical component is any component of a device or system whose failure to perform can be reasonably expected to cause the failure of the device or system, or to affect its safety or effectiveness. Cypress is not liable, in whole or in part, and you shall and hereby do release Cypress from any claim, damage, or other liability arising from or related to all Unintended Uses of Cypress products. You shall indemnify and hold Cypress harmless from and against all claims, costs, damages, and other liabilities, including claims for personal injury or death, arising from or related to any Unintended Uses of Cypress products.

Cypress, the Cypress logo, Spansion, the Spansion logo, and combinations thereof, WICED, PSoC, CapSense, EZ-USB, F-RAM, and Traveo are trademarks or registered trademarks of Cypress in the United States and other countries. For a more complete list of Cypress trademarks, visit cypress.com. Other names and brands may be claimed as property of their respective owners.

Contents



Safety Information	4
Regulatory Compliance	4
General Safety Instructions	5
1. Introduction	6
1.1 Kit Introduction.....	6
1.2 Block Diagrams	7
1.3 Features	7
2. Getting Started	9
2.1 WSN Operation with PC	9
2.2 WSN Operation with a Mobile Device.....	10
3. Hardware	14
3.1 Solar BLE Sensor	14
4. Enclosure	16
4.1 Solar BLE Sensor Enclosure	16
4.2 How to Install the Board in the Enclosure	17
Revision History	19

Safety Information



Regulatory Compliance

The CYALKIT-E03 Solar-Powered Bluetooth Low Energy (BLE) Sensor Beacon 5 Pack is intended for use as a development platform for hardware or software in a laboratory environment. The board is an open system design, which does not include a shielded enclosure. This may cause interference with other electrical or electronic devices in close proximity. In a domestic environment, this product may cause radio interference. In this case, the user may be required to take adequate preventive measures. Also, the board should not be used near any medical equipment or RF devices.

Attaching additional wiring to this product or modifying the product operation from the factory default may affect its performance and cause interference with other apparatus in the immediate vicinity. If such interference is detected, suitable mitigating measures should be taken.



The CYALKIT-E03 Solar-Powered BLE Sensor Beacon 5 Pack as shipped from the factory has been verified to meet the requirements of CE as a Class A product.



The CYALKIT-E03 Solar-Powered BLE Sensor Beacon 5 Pack contains electrostatic discharge (ESD) sensitive devices. Electrostatic charges readily accumulate on the human body and any equipment and can discharge without detection. Permanent damage may occur to devices subjected to high-energy discharges. Proper ESD precautions are recommended to avoid performance degradation or loss of functionality. Store unused CYALKIT-E03 boards in the protective shipping package.



End of Life/Product Recycling

The end of life of this kit is five years after the date of manufacture mentioned on the back of the box. Contact your nearest recycler to discard the kit.

General Safety Instructions

ESD Protection

ESD can damage boards and their associated components. Cypress recommends that you perform procedures only at an ESD workstation. If one is not available, use appropriate ESD protection by wearing an antistatic wrist strap attached to chassis ground (any unpainted metal surface) on your board when handling parts.

Handling Boards

CYALKIT-E03 boards are sensitive to ESD. Hold the board only by its edges. After removing the board from its box, place it on a grounded, static-free surface. Use a conductive foam pad, if available. Do not slide the board over any surface.

1. Introduction



Thank you for your interest in the CYALKIT-E03 Solar-Powered BLE Sensor Beacon 5 Pack. The Solar-Powered BLE Sensor Beacon 5 Pack is an expansion pack for [CYALKIT-E02 Solar-Powered BLE Sensor Beacon RDK](#). It provides an easy-to-use platform for the development of a tiny solar-powered IoT device with BLE wireless connectivity. The CYALKIT-E03 consists of five Solar BLE Sensors. The Solar BLE Sensor is based on Cypress's energy-harvesting power management IC (PMIC) S6AE103A, and EZ-BLE products. The objective of this CYALKIT-E03 is to provide a fully functional battery-less wireless sensor node (WSN). The Solar BLE Sensor will be enclosed in a casing to automatically transmit temperature and humidity sensor data in an office lighting environment. Each beacon can be placed in a very small remote location due to its size and battery-free operation. The sensor data is transmitted to a BLE device and sent to the cloud for analysis.

This kit guide explains how to set up and use the CYALKIT-E03. Be sure to read it before using the product. For questions, please consult with sales or support representatives.

Note: All information included in this document is current as of the date it was issued. Such information is subject to change without any prior notice. Please confirm the latest relevant information with the sales representative.

1.1 Kit Introduction

Figure 1-1. Kit Contents

1 x 5 pcs

2

- Five Solar-Powered BLE Sensor Beacons (Solar BLE Sensor)¹
 - Board + Enclosure
- Quick Start Guide

¹ To program, debug, and set the parameters on Solar BLE Sensor, you need at least one Debug Board (Not included in the package) that is included in [CYALKIT-E02 Solar-Powered BLE Sensor Beacon RDK](#).

1.2 Block Diagrams

Figure 1-2. Block Diagram of Solar BLE Sensor

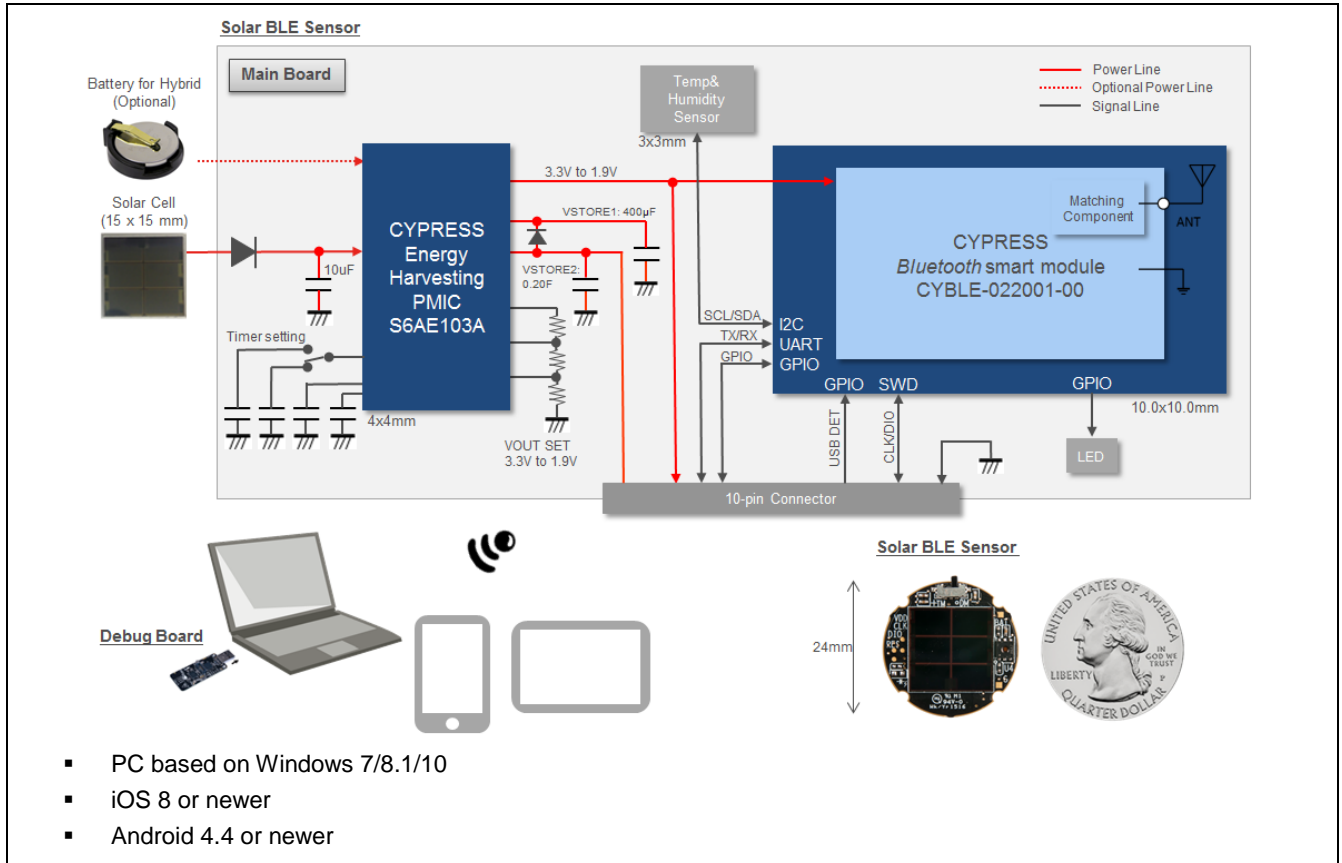

1.3 Features

The CYALKIT-E03 Solar-Powered BLE Sensor Beacon 5 Pack provides everything needed to develop a light-powered sensor node that transmits sensor data using Bluetooth Low Energy (BLE):

- Tiny solar-powered BLE sensor board (circle with 24-mm diameter, same size as 25-cent coin)
- Operates using light energy harvested (>100 lux) by the included solar cell
- Supports BLE communication with a mobile device (iOS 8 or newer/Android 4.4 or newer)
- Energy harvesting PMIC S6AE103A that supports the following applications:
 - Demo mode, transmitting sensor data at 3- to 60-second intervals (without charging to a supercapacitor)
 - Timer mode, transmitting sensor data at 5-minute intervals while charging to the supercapacitor
 - Transmitting data at over 30 hours without ambient light (when mode is set to Timer mode and supercapacitor is fully charged)
- Solar BLE Sensor that can support the following:
 - Selection of mode using a slide switch (Demo or Timer mode)
 - Programming and debugging of the EZ-BLE module via Debug Board
 - Parameter setting of BLE Beacon via Debug Board
 - Charging of surplus solar energy to a 0.2-F supercapacitor (Timer mode)

- Charging of supercapacitor via Debug Board using USB bus power
- Temperature and humidity digital sensor
- Expandable interface via 10-pin connector (GPIO)
- Test pads for power, ground, primary battery input, and SWD interface for programming
- Uses the following Cypress devices:
 - S6AE103A ultra-low-power energy harvesting PMIC
 - CYBLE-022001-00 EZ-BLE PRoC module

2. Getting Started



In this chapter, you will become familiar with the Solar-Powered BLE Sensor Beacon 5 Pack by successfully establishing a BLE sensor beacon connection between the Solar BLE Sensor operating as a wireless sensor network (WSN), a mobile device with apps. This will also confirm that the Solar BLE Sensor and your mobile device are operating properly.

2.1 WSN Operation with PC

In this section, you will confirm that the Solar BLE Sensors is operating as a WSN by using the software provided on your mobile device to detect temperature and humidity changes.

2.1.1 Establishing BLE Connection

1. Set the slide switch (SW1) on the five Solar BLE Sensors to Demo mode (DM). The mode is set to Demo Mode from the factory setting. Refer to [CYALKIT-E02 Kit Guide](#) for detailed information on each mode.

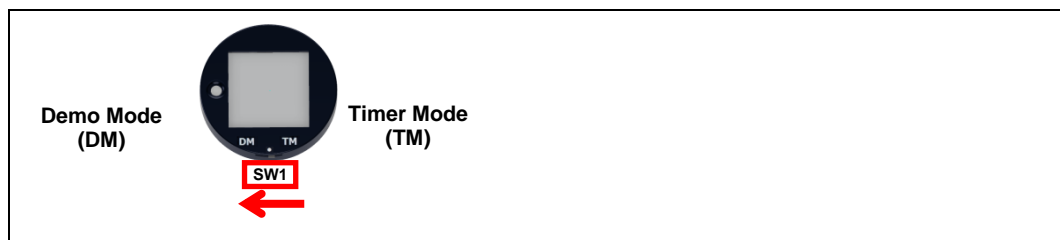

Note: Use the sharp end of something like tweezers (not included in the kit) to change the mode.

2. Each Solar BLE Sensors are numbered with the IDs (#2 to #6) on the bottom side of the enclosure from the factory. Refer to [CYALKIT-E02 Kit Guide](#) for information on how to change the ID.



- Place the five Solar BLE Sensors under an office light. After placing the Solar BLE Sensors under a suitable light (refer to Table 2-1. Light Level Versus Time Interval), it will automatically power up and begin transmitting.

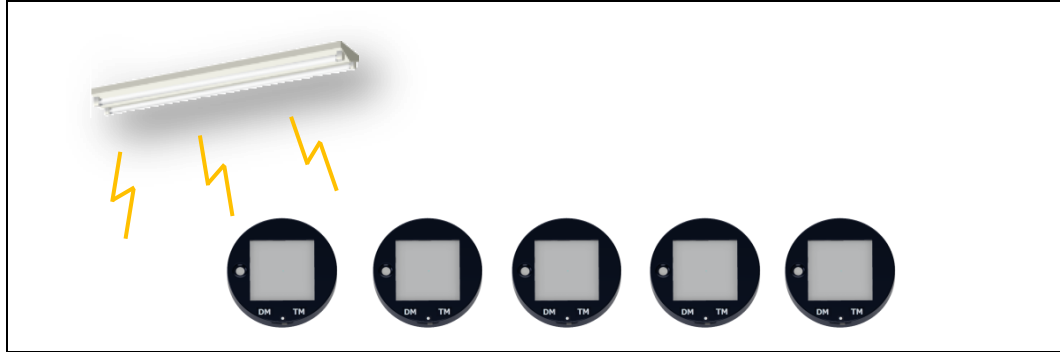

Table 2-1. Light Level Versus Time Interval

Typical Light Level	Environment	Time Interval of Sensor ¹
~1 lx	Moonlight	Does not work
100 lx~200 lx	Under street lighting	50 s ~
200 lx~400 lx	At museum	30 s ~ 50 s
400 lx~500 lx	Office lighting	15 s ~ 30 s
1000 lx ~	Shopping mall, rainy day	3 s ~ 15 s

¹The time interval of the sensor will be three seconds in all light levels when the supercapacitor on the Solar BLE Sensor is fully charged.

2.2 WSN Operation with a Mobile Device

In this section, you will confirm that the Solar BLE Sensors are operating as a WSN by using the apps on your mobile device to detect temperature and humidity changes.

2.2.1 Mobile Apps Installation

The Cypress BLE-Beacon app is available on Google Play and in the Apple Store for free. To install the app, follow these instructions.

2.2.1.1 Installing the Android App

- Open Google Play and search for “Cypress BLE-Beacon”.

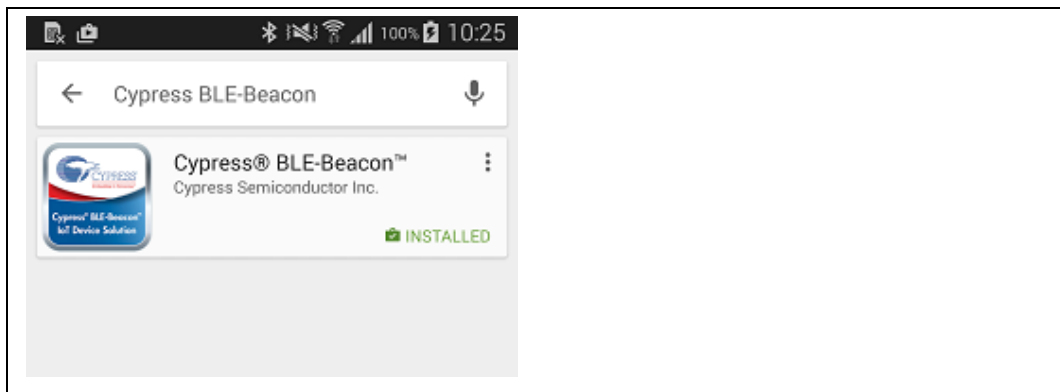

2. Select the Cypress BLE-Beacon (BLE-Beacon) app. On the subsequent screen, click the **Install** button to proceed with installation.
3. When presented with the app permission dialog, click **Accept** to continue.
4. When the installation is complete, the BLE-Beacon app can be launched from the App Drawer.
5. Place the Solar BLE Sensor under an office light. Refer to step 3 of [2.1.1 Establishing BLE Connection](#).
6. Launch the BLE-Beacon app. A splash screen is displayed for a few seconds before the app displays the **Device List** screen. If Bluetooth is turned OFF in the Android device, Android OS will prompt you to turn ON Bluetooth.

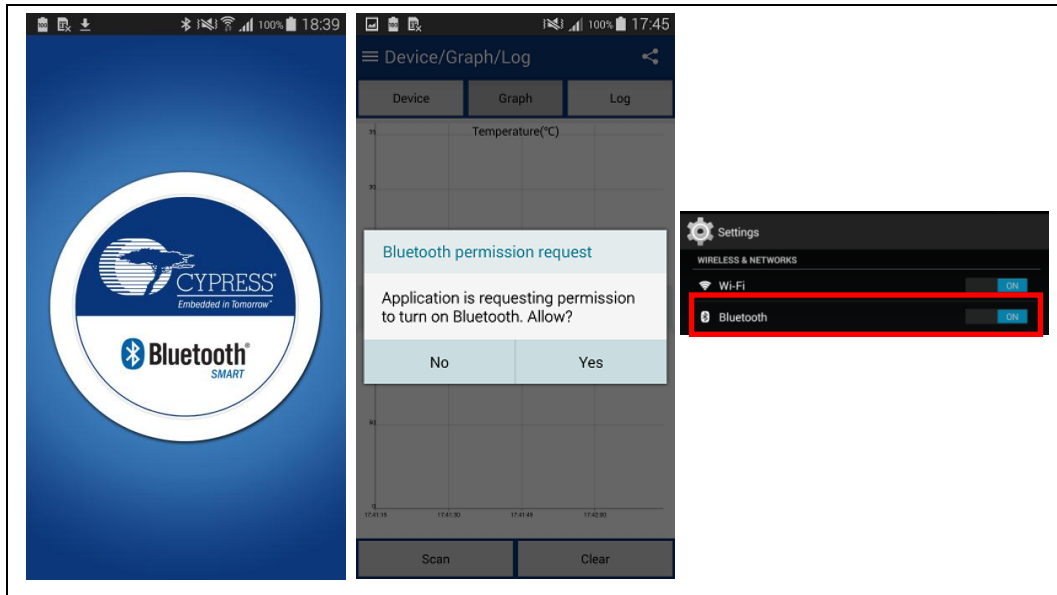

7. The BLE-Beacon app performs device discovery by default when the app is opened. Select the mode as **Graph** to display the sensor data. You can recognize the five data (#2 to #6) on the graph screen.

Note: If evaluating this demo near same ID of other Kit, the Graph will show incorrect data. In this case, disable transmitting BLE data of all other kits and then repeat this step.

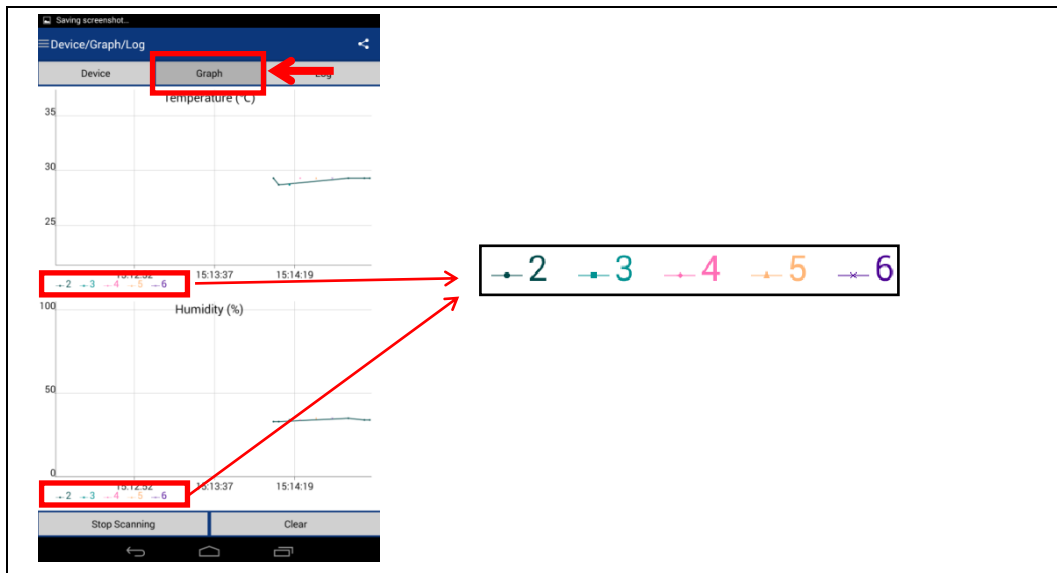

Refer to [Cypress BLE-Beacon Android App User Guide](#) for detailed information.

2.2.1.2 Installing the iOS App

1. Open App Store and search for “Cypress BLE-Beacon.”

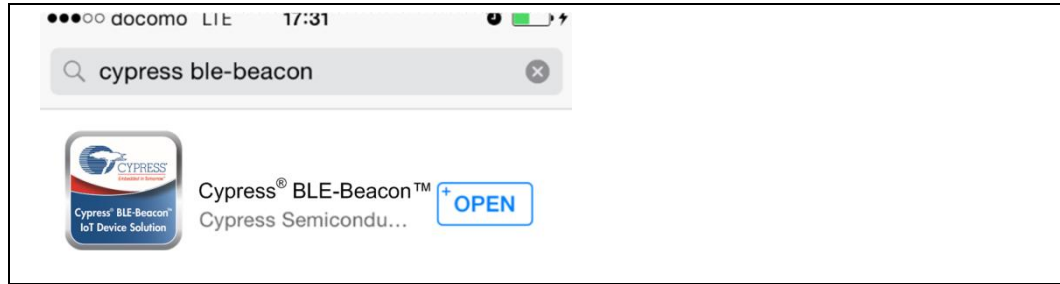

2. Select the Cypress BLE-Beacon (BLE-Beacon) app, and proceed to install the app on your iOS device.
3. Place the Solar BLE Sensor under an office light. Refer to step 3 of [2.1.1 Establishing BLE Connection](#).
4. Launch the BLE-Beacon app. A splash screen is displayed for a few seconds before the app displays the **Device List** screen. If Bluetooth is turned OFF in the iOS device, iOS will display a message box to turn ON Bluetooth with the **Settings** and **OK** buttons. Click the **Settings** button to turn ON Bluetooth on the **Settings** screen. Clicking the **OK** button will display the message “Please turn Bluetooth ON,” which requires the standard iOS procedure to turn ON Bluetooth.

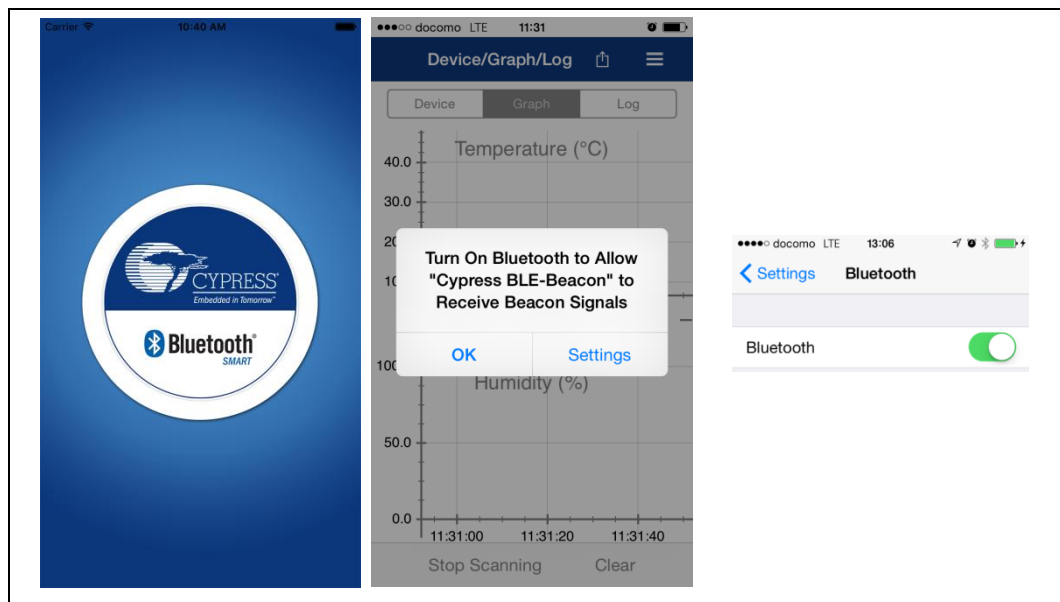

5. The BLE-Beacon app performs device discovery by default when the app is opened. Select the mode as **Graph** to display the sensor data. You can recognize the five data (#2 to #6) on the graph screen.
Note: If you are evaluating this demo near the same ID of another Kit, the Graph will display incorrect data. In this case, disable transmitting BLE data of all other kits and then repeat this step.

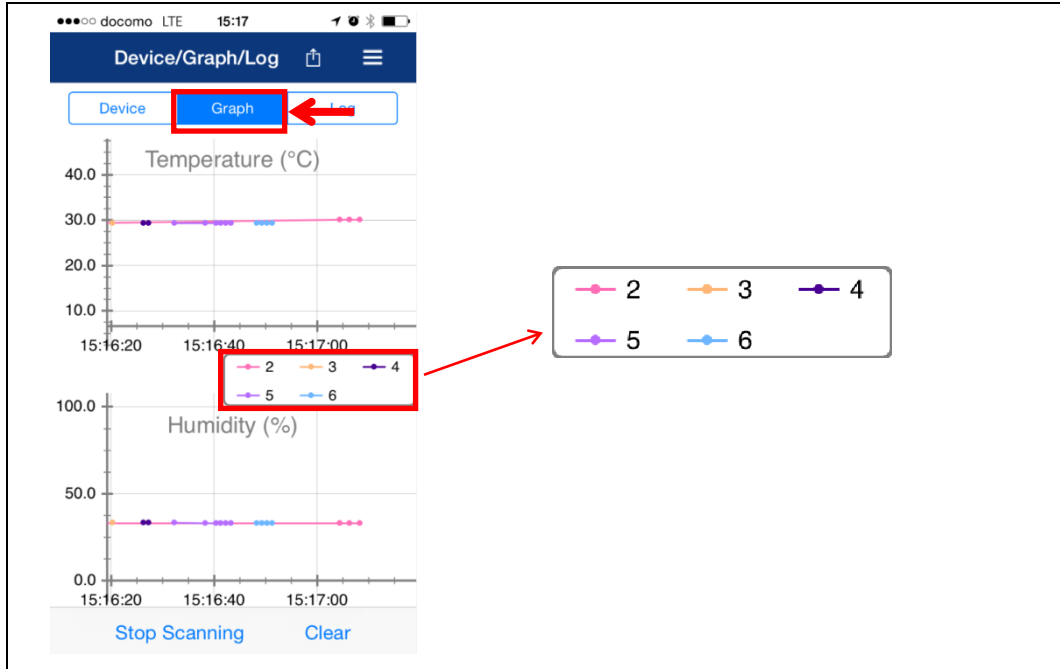

Note that if the sensor data has not appeared on the BLE-Beacon of iOS, you need to confirm that the **Location** setting is set to **While Using the App** (iOS: Home screen > Settings > BLE-Beacon > Location).

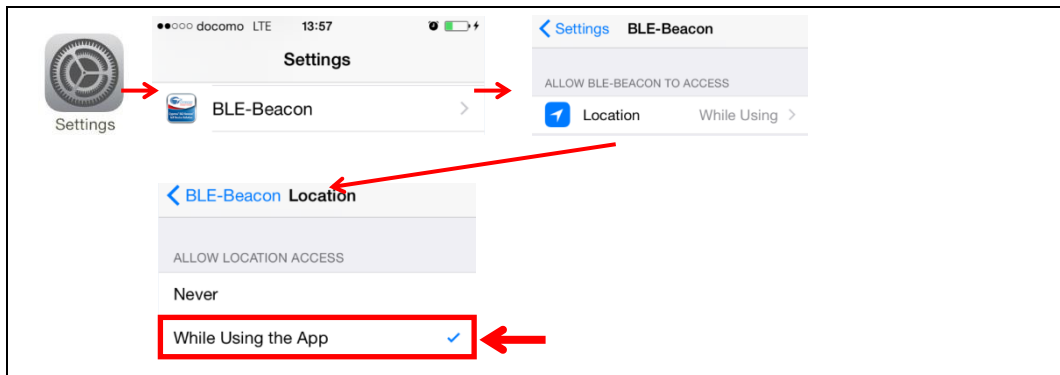

Refer to [Cypress BLE-Beacon iOS App User Guide](#) for detailed information.

3. Hardware



This chapter describes the Solar-Powered BLE Sensor Beacon 5 Pack hardware. The schematic and board layouts are available at the [CYALKIT-E02](#) location:

<Install Directory>\Cypress\CYALKIT-E02 Solar-Powered BLE Sensor Beacon RDK<version>\Hardware.

3.1 Solar BLE Sensor

The Solar BLE Sensor consists of the blocks shown in [Figure 3-1](#).

Figure 3-1. Solar BLE Sensor Block Diagram

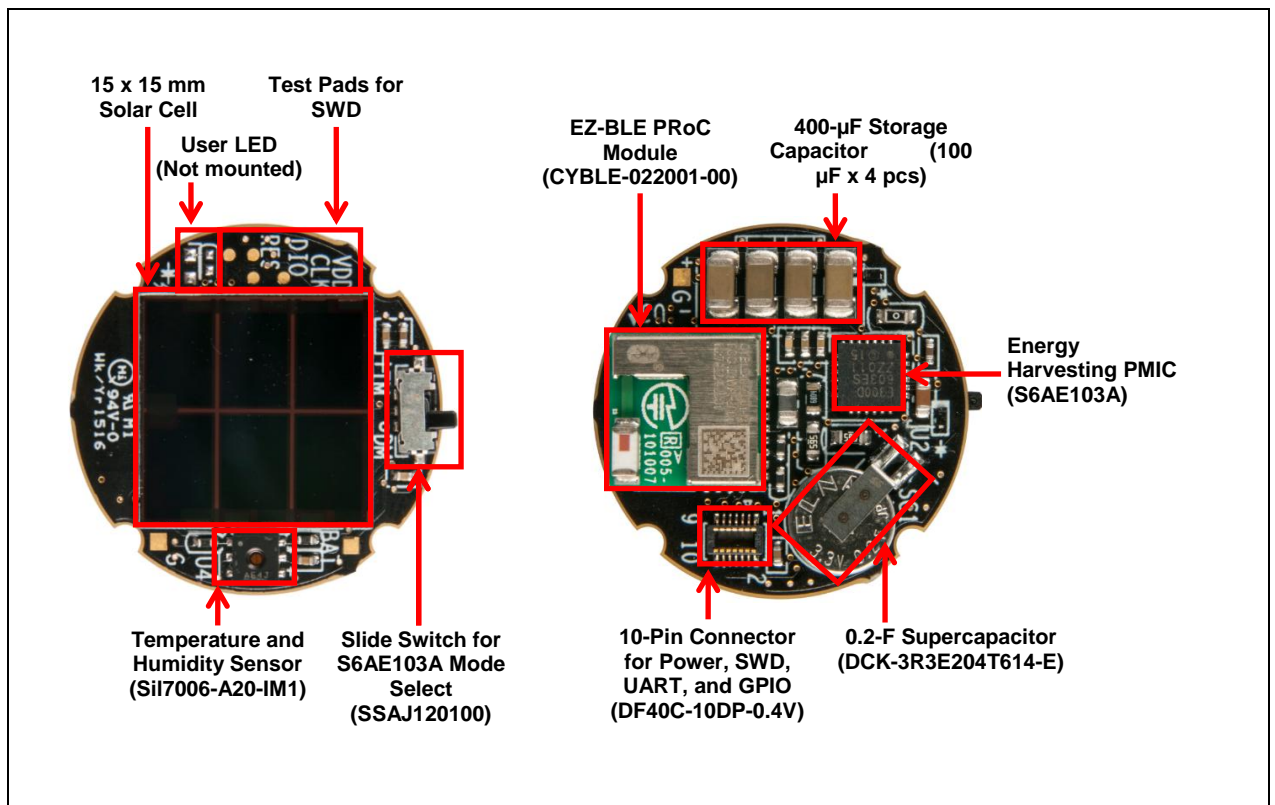

Note that the Solar BLE Sensor is not printed on the silk screen of all components due to tiny size. To identify the components, refer to the assembly drawing shown in [Figure 3-2](#).

Figure 3-2. Solar BLE Sensor Assembly Drawing

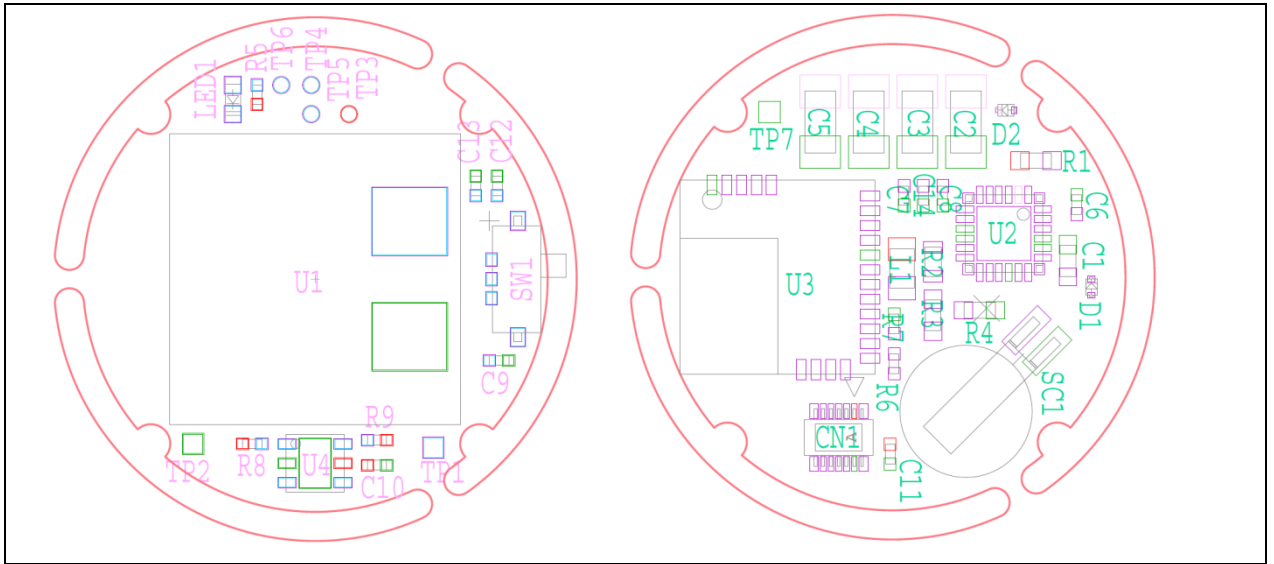

Refer to [CYALKIT-E02 Kit Guide](#) for detailed information on each block.

4. Enclosure



4.1 Solar BLE Sensor Enclosure

The kit includes an enclosure for the Solar BLE Sensor, shown in the following image. It contains three parts: a top cover, a bottom cover, and the transparent sheet for solar cell.

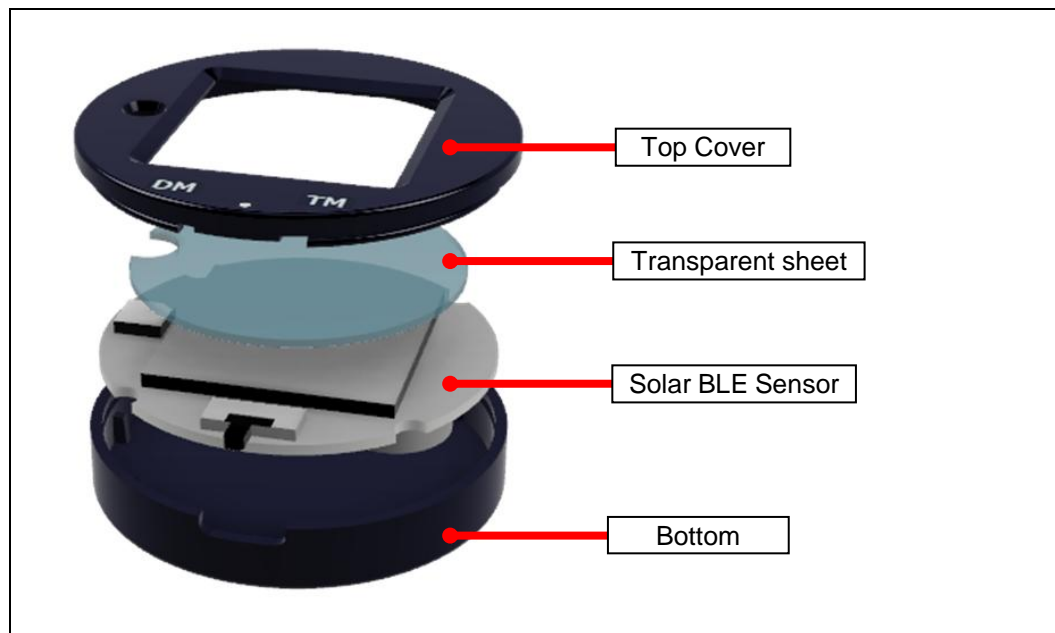

4.2 How to Install the Board in the Enclosure

Use the following steps to install the Solar BLE Sensor board in the enclosure.

1. Set the transparent sheet to top cover as shown below.

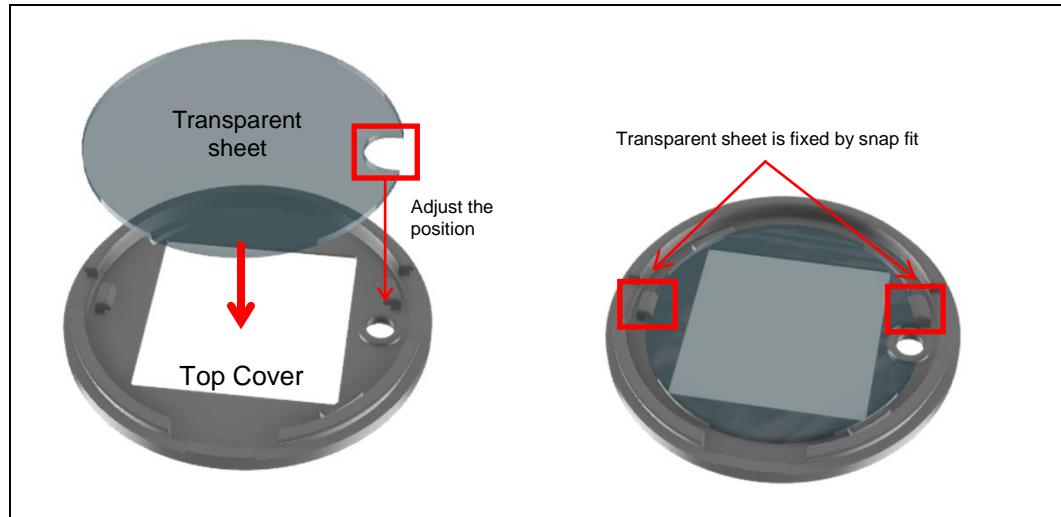

2. Adjust the position of the circle mark on the bottom cover and SW1 on the Solar BLE Sensor. Put in the Solar BLE Sensor in the bottom cover.

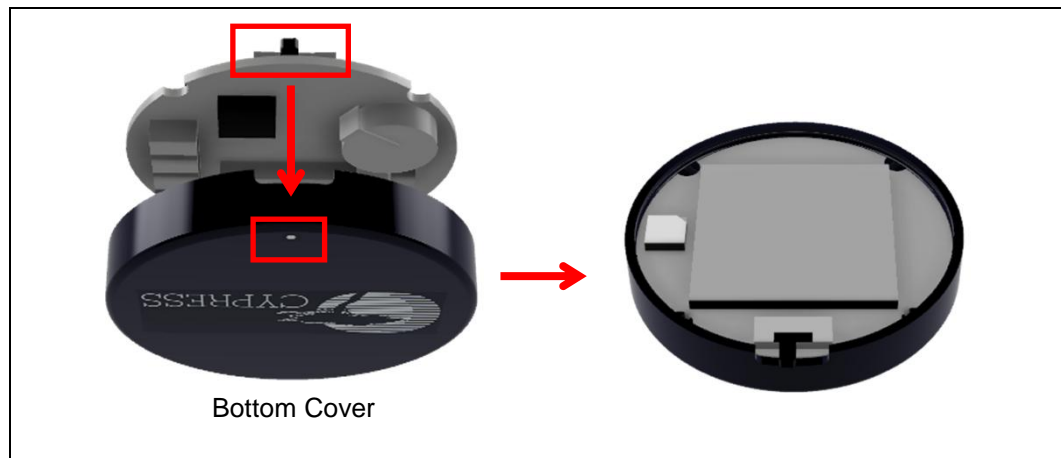

3. Adjust the position of the circle mark on the top cover and SW1 on the Solar BLE Sensor. Install the top cover on the bottom cover.

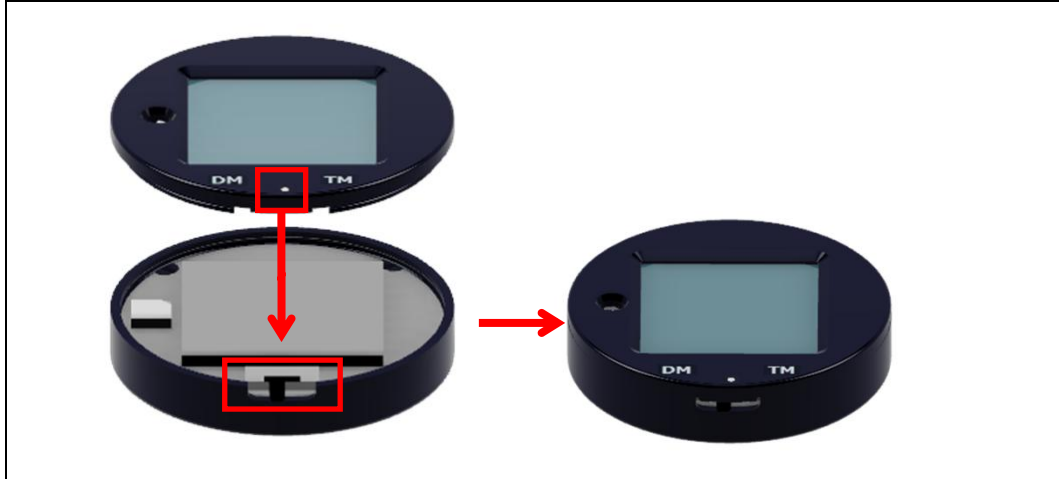

Revision History



Document Revision History

Document Title: CYALKIT-E03 Solar-Powered BLE Sensor Beacon 5 Pack Kit Guide

Document Number: 002-12543

Revision	Issue Date	Origin of Change	Description of Change
**	04/28/2016	EIFU	Initial release
*A	04/07/2017	EIFU	Updated template