

# Zinc-Oxide-Praseodymium based Multilayer Chip Varistors

## AVR-M, AVRL, AVF16 Series

### Conforming to RoHS Directive

Conformity to RoHS Directive: This means that, in conformity with EU Directive 2002/95/EC, lead, cadmium, mercury, hexavalent chromium, and specific bromine-based flame retardants, PBB and PBDE, have not been used, except for exempted applications.

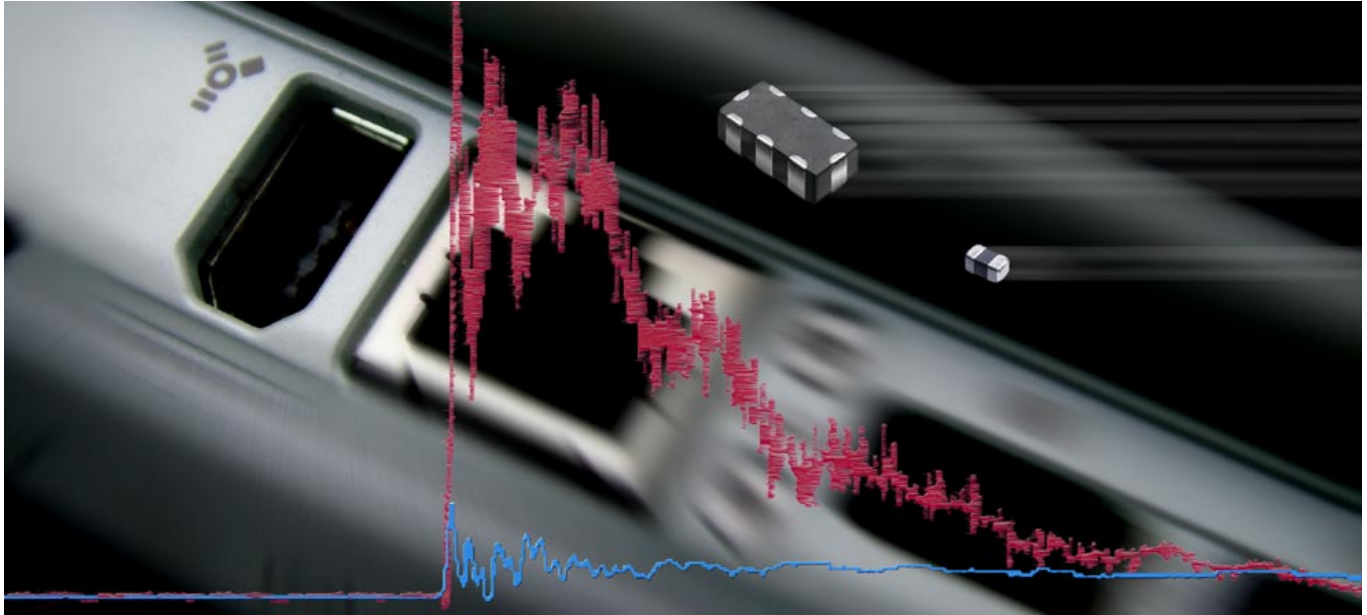

### Development Background / Product Features

By using ICs or micro computers, the performance of electronic devices and household electronics continues to improve, as they become faster and more compact. Many eye-opening developments are occurring in the systemization of various applications and scales. However, due to the progress being made in efforts toward integration and low-power consumption, anti-noise characteristics of ICs and micro computers are becoming increasingly sensitive and unstable.

Because of this trend, we are seeing an increased urgency for varistors with strong ESD and pulse noise deterrent capabilities, which are required to prevent device malfunction.

TDK, which is constantly looking to improve its fine-ceramics technology, possesses industry leading advanced varistor technology. We have a complete line of exclusively designed multilayer chip products to answer the most demanding requirements for varistor voltage and other special needs.

This section is intended as an introduction to the characteristics and detailed construction of our zinc oxide varistor. We also provide an explanation of the multilayer chip technology which allows us to quickly respond to advanced circuit design requirements.

### Voltage vs. current characteristics of the varistor

As shown in the following characteristic graph, a varistor is an element that displays voltage - current characteristics similar to a Zener diode (voltage non-linearity), in that when applied voltage reaches a certain level, electric current that up to that point has been all but dormant suddenly begins to flow.

Here, the voltage that serves as a measure of the varistor operation is generally indicated by the voltage of the fixed current. From the perspective of measurement and application, normally the voltage between varistor terminals when a 1mA\* current flows to the varistor is used.

\*Voltage-current characteristics vary depending on element shape and values such as 0.1mA or 10mA may also be used.

**Varistor voltage vs. current characteristics example**  
(voltage non-linearity)

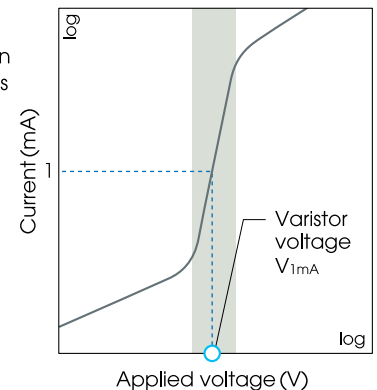

## Development Background/Product Features

Below shows a general example of excessive voltage reduction with varistors. By inserting varistors in parallel alignment into circuits, ICs, or LSIs you wish to protect, it is possible to produce superior voltage control properties. Because of the properties noted above, almost no electric current from the applied power source voltage flows to the varistor. However, when excess voltage is applied to the circuits, and that voltage level reaches or exceeds the preset voltage limits (varistor voltage), varistor resistance is suddenly reduced and excess voltage flows to the grounding wire as surge current. In short, this function specific to varistors, which are variable resistors, results in the dramatic decrease of excess applied voltage.

### Varistor-based IC operation protection measures example

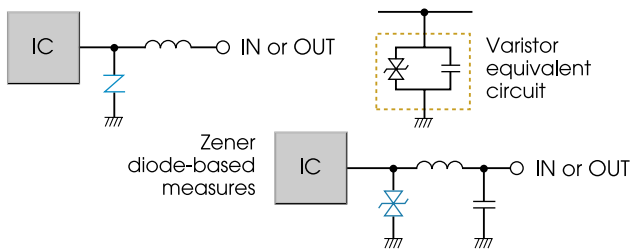

#### Chip varistor application merits

Compact and lightweight. Space saving and cost reduction possible due to reduction in number of parts  
Achieves higher break down voltage than Zener diodes.



Will support immunity enhancement in small devices

Furthermore, unlike Zener diodes, varistors have extremely high withstanding voltage. By choosing varistors possessing low clamping voltage levels lower than the withstanding voltage of circuits or semiconductor elements, it is possible for semiconductors, upon which various electric and electronic circuits depend, to avoid the danger of device unreliability, such as element damage and circuit malfunction, caused by irregular surges, particularly electrostatic discharge. On the right is the result using the human body model, and the under is the result of TTL parallel ESD test (example of comparison with a Zener diode).

### Principle behind varistor characteristics

By controlling the crystal generation process (sintering process), low resistance zinc oxide crystalline particles and an extremely thin, high resistance boundary layer are formed. The superior current-voltage characteristics (non-linear voltage) of zinc oxide vari-

### Effectiveness of ESD measures example

IEC61000-4-2 compliant  
Human body model (150pF/330Ω)/contact discharge  
Level 1 (Recharge voltage:2kV) 50Ω input/60dB attenuator used

#### Before measures

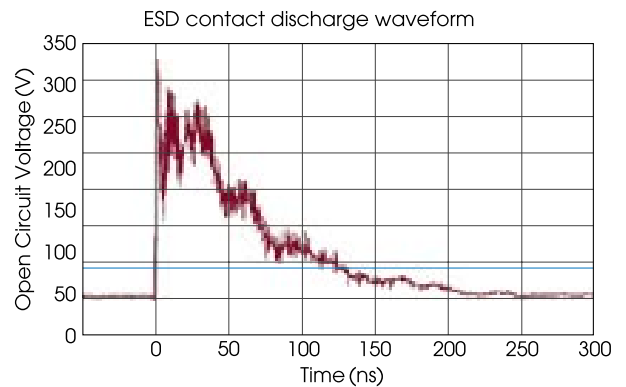

#### After measures

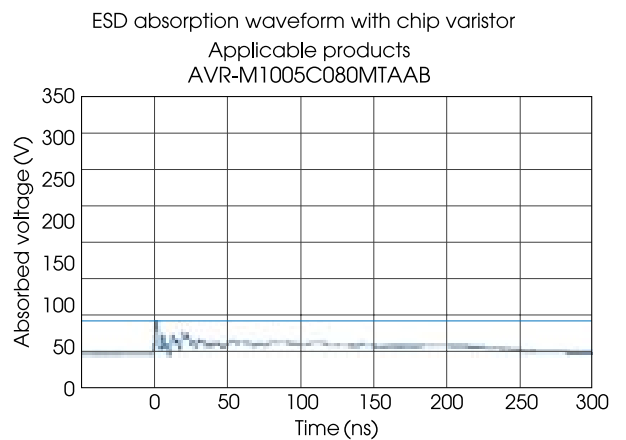

### TTL parallel ESD tests

ESD test equipment: Noise Laboratory, Co., Ltd. ESS-630A  
150pF/330Ω/Contact discharge  
(discharge location: between GATE-GND)

- ◇ AVR-M2012C120MT6AB
- AVR-M1608C120MT6AB

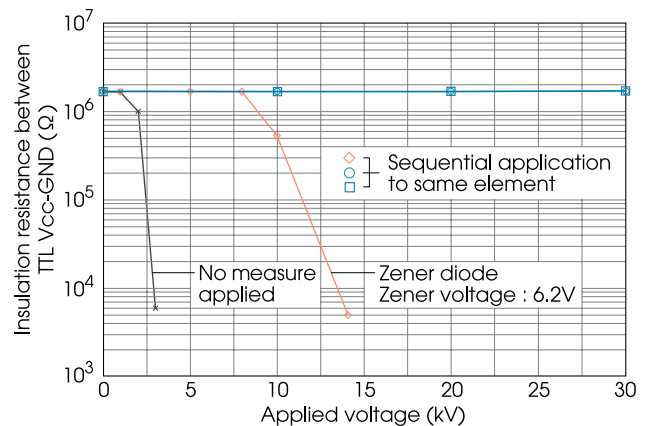

# AVR-M, AVRL, AVF16 Series



stors is a result of the specific structure of varistor crystal shown in the picture below : a three-dimensional “multiple connection structure” where a high resistance boundary layer surrounds low resistance crystalline particles.

### Varistor crystal multiple connection structure

Conventional material for disk varistors

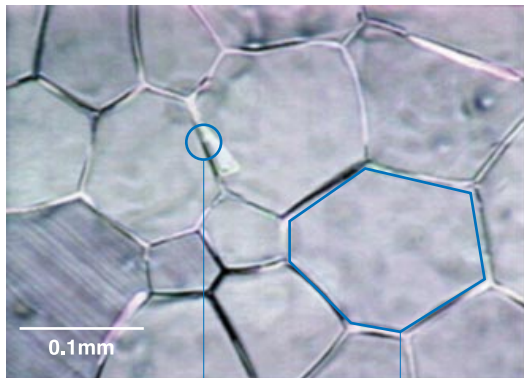

High-resistance grain boundary

Micro crystalline particles (grains)

Many different proposals were made for the non-ohm conductive mechanism model that explains the superior non-linear voltage properties displayed by the zinc oxide varistor. Even today, there isn't a single model that has been able to explain every phenomenon. However, it is almost a certainty that the double Schottky barrier formed by the high resistance crystalline boundary region and the low resistance zinc oxide crystalline particles plays the leading role in this show of superior non-linear voltage properties, and it is believed that the phenomenon where electric current suddenly flows at a specific voltage level is due to the tunnel configuration.

### Double Schottky barrier model

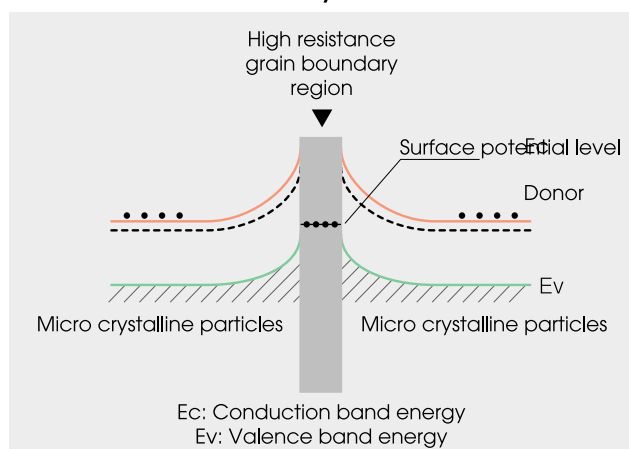

In recent years, frequent tests have been conducted that directly measure single boundary layer properties through samples in which methods such as thin film multilayering or providing polycrystalline films with sputtered electrodes have been used. It has been confirmed that critical voltage level (varistor voltage) generated by the tunnel effect in the “crystalline particle – crystal boundary layer – crystalline particle” unit of the zinc oxide varistor is 2.5 to 3.5V. This value is about 1V larger than the value calculated using the average crystal particle diameter of the actual element. However, it is believed that this difference exists because the crystalline particles of the actual element have a certain level of particle size distribution and because the microscopic conductive path between electrodes that includes crystalline particles with a larger-than-average diameter reaches the critical level at a lower voltage than other areas. A summary of the relationship between the shape and major characteristics of the zinc oxide varistor, based on the above configuration and conductive mechanism models, is given below.

### Clamping voltage/ Maximum clamping voltage

When the varistor releases excessive voltage as surge current, the voltage added between the varistor terminals is known as clamping voltage. The clamping voltage will vary depending on the size of the surge (amplitude) current flowing to the varistor.

In addition, the amplitude of the surge current that serves as a measure of the clamping voltage is determined by the surface area of the varistor. The maximum value of the clamping voltage for a specific wave amplitude is called the maximum clamping voltage. In other words, when a current below the determined current amplitude flows to the varistor, the voltage between the varistor terminals is constrained to a voltage below the maximum clamping voltage.

Furthermore, the maximum clamping voltage changes depending on the waveform of the current, and the more suddenly the electric current occurs, the more the maximum clamping voltage increases. Normally, this is represented by the maximum value of the voltage waveform when an impulse current of standard waveform  $8/20\mu s$  is released.

### Relationship between the shape and major characteristics of the varistor

Based on observations, it is understood that varistor voltage can be controlled by changing the number of series of the crystalline boundaries that exist between electrodes. When the diameter of crystal particles is uniform, varistor voltage increases as the thickness of elements get larger. When the thickness dimen-

## Development Background/Product Features

sions are uniform, elements with a smaller crystal particle diameter possess a larger varistor voltage. The amount of surge resistance is dependent upon the parallel number, in other words, the element area. Elements with a larger surface area can withstand a larger surge current. When the surface area is uniform, elements with a smaller crystal particle diameter are stronger.

Also, the voltage threshold level that varies with the amplitude of the surge current is also dependent on the surface area of the elements. When the surge amplitude is the same, elements with a larger surface area have a lower voltage threshold. Furthermore, the energy toleration level is dependent on the volume of the elements. Even if the amplitude is not very high, there is a need to consider element volume in the event of surge currents that continue over an extended period of time.

### Features of the TDK Multilayer chip varistor

Currently, commercialized zinc oxide varistors can be largely divided into two categories depending on the differences in their major additives. These additives are bismuth and praseodymium. Even within the same zinc oxide varistor, these two substances have completely different physical properties and deterioration that occur when extreme stress is applied continuously to the varistor.

#### Bismuth ZnO-based element deterioration test results

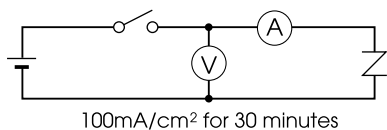

- A:** Deterioration status in the forward direction as test voltage applied
- B:** Deterioration status in the reverse direction as test voltage applied

Before test voltage applied  
(initial characteristics)

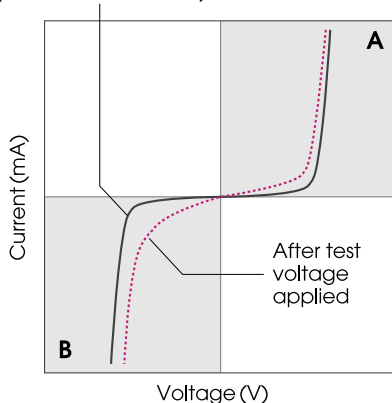

The graph shown at the lower left is the deterioration test result using bismuth-based test sample. In this test, large current stress ( $100\text{mA}/\text{cm}^2$ ) was impressed for 30 minutes to accelerate the deterioration. The symmetry property of the voltage-current characteristic greatly deteriorates after deterioration and, as a result, a voltage difference between forward direction (A) voltage and reverse direction (B) voltage, in other words, a polarity will appear in the varistor voltage. This inclination means that leaked current when a bias current is applied gets larger, and is a major cause of battery depletion and IC malfunction.

### Strength of new composition that vastly outperforms current limit

The result of TDK's material composition tests was that by using our exclusive technology which combines praseodymium with several other base elements, we were able to create new properties that maintain symmetry while controlling deterioration. Deterioration test result is shown below.

#### New composition TDK AVR-M Series deterioration test results

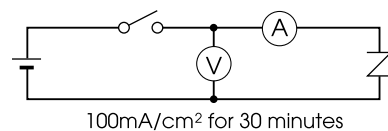

- A:** Deterioration status in the forward direction as test voltage applied
- B:** Deterioration status in the reverse direction as test voltage applied

Before test voltage applied  
(initial characteristics)

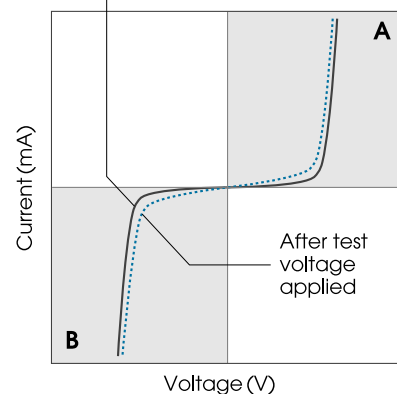

We performed the same tests using bismuth-based materials, but we could not achieve the additional effect by adding several base elements. The following page shows an ESD endurance comparison between the conventional bismuth ZnO chip varistor and the new praseodymium ZnO chip varistor (AVR-M Series).

# AVR-M, AVRL, AVF16 Series



### Anti-ESD characteristic of AVR-M Series

Example of comparison with conventional materia

- TDK AVR-M Series 1608 type
- Bismuth ZnO-based 1608 type from other companies

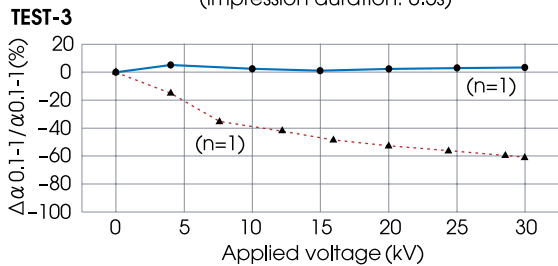
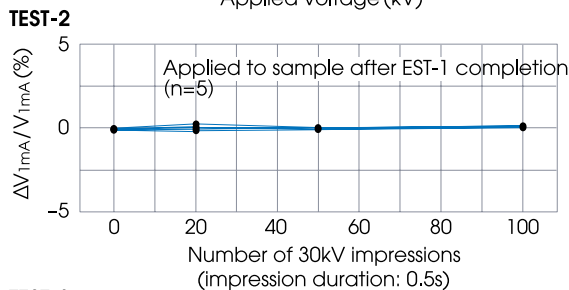
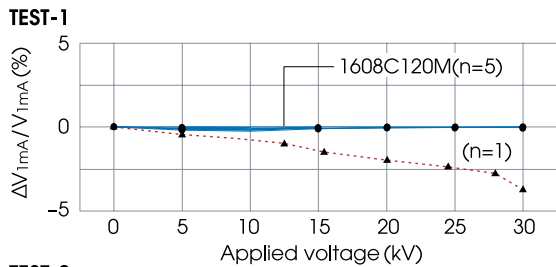

### Challenges in creating an ultra-miniature 1005 chip varistor

As was described above, the physical properties of a varistor are:

- 1) Surge endurance is reduced as the electrode surface area gets smaller.
- 2) Incredibly thin varistor elements are required to achieve the 12V-18V level varistor voltage needed for low voltage circuits.

Over the past several years, these properties have been significant barriers in the attempt to create a micro-sized chip varistor.

We at TDK have been able to overcome these barriers by applying our advanced fine structure control technology and our multilayer technology, which has allowed us to stretch the limits of accuracy. We have established a mass production process that controls internal electrode shape (area) and internal electrode dimensions on the order of microns. Our micro-sized 1005 model responds to the advanced requirements in small device circuit design, and has allowed us to introduce ESD absorption vs. varistor voltage prod-

uct lineup. Currently, we are focusing on expanding the lineups of the 0603 type and 2-element built-in 2-line array type.

### AVR-M Series microstructure

AVR-M Series 1005 type microstructure

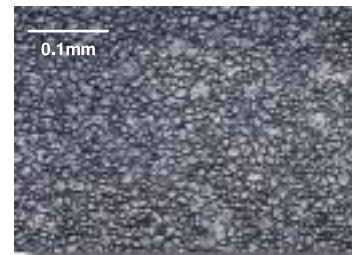

Compared to bismuth-based varistors, not only is symmetry throughout deterioration optimal, but leakage current during bias current impression has been reduced, making this varistor perfect for EMC circuit design in small mobile devices.

Comparison material: conventional material used in disk varistor discs.

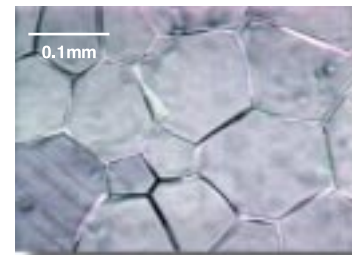

Features of the AVR-M Series 1005 type are provided below.

### High-speed responsiveness and minimized current leakage

Using our advanced fine structure control technology to form uniform ultra-fine crystal grains, we have achieved quick responsiveness that surpasses that of Zener diodes, and have been able to constrain leakage during bias current application to a minimum.

### Highly stable absorption properties

Through the application of new praseodymium zinc oxide-based semiconductor material (patented), which contains our exclusive additive control, we have achieved world-leading surge endurance levels. The levels are high enough to withstand our high voltage impression test where 30kV was applied repeatedly 100 times. This varistor displays unpolarized symmetry equivalent to that of Zener diode anode common types, and there is none of the leakage current asymmetrical deterioration seen in bismuth zinc oxide chip elements.

## Development Background/Product Features

### Development of a low capacitance product

With our high-precision multilayer technology, we are now able to introduce a line of products that dramatically control capacitance between internal electrodes. For example, a low capacitance model can be used to protect signal lines that are sensitive to waveform distortions (such as RGB signal lines). Our main line of products combines the strong varistor effects needed for GND lines and DC power lines, which are in danger of exposure to irregular voltage, and the features of a bias capacitor. Our new line of products has made this kind of high-efficacy use possible.

### Space-saving, high-performance merits

Our new varistor has received much praise for offering a mounting surface that is less than 1/2 the size of the Zener diode, while providing better performance reliability. This product is being heavily used as a protective measure in the various products that keep pushing the demands for higher performance from cellular phones and note PC HDDs, to mobile AV devices, PDAs, and game devices.

#### 1005 model space-saving efficacy example

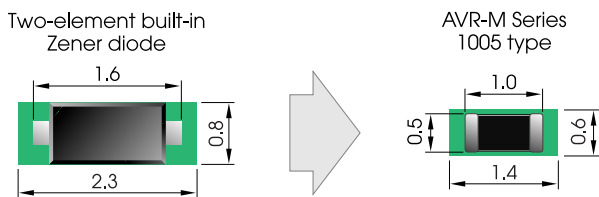

### Less than 1/2 mounting surface

■ Circuit board area including land patterns (Dimensions in mm)

### Creation of nickel barrier and tin-plated terminals

Furthermore, we have established the world's first nickel (Ni) barrier and tin (Sn)-plated terminal electrode formation process for use in zinc oxide varistors. This design has superior solder wettability and heat endurance properties, meaning you can count on its reliability after mounting.

### Launching new series and our future efforts

As well as the high-level integration of semiconductor elements and increased power-saving, we expect to see an increasingly rapid movement toward smaller, lighter mobile devices such as mobile phones and PDAs, which will continue to increase their features and multi-functional capabilities. This means that there will be an increased demand on chip varistors

### AVR-M Series multilayer construction and terminal electrode process

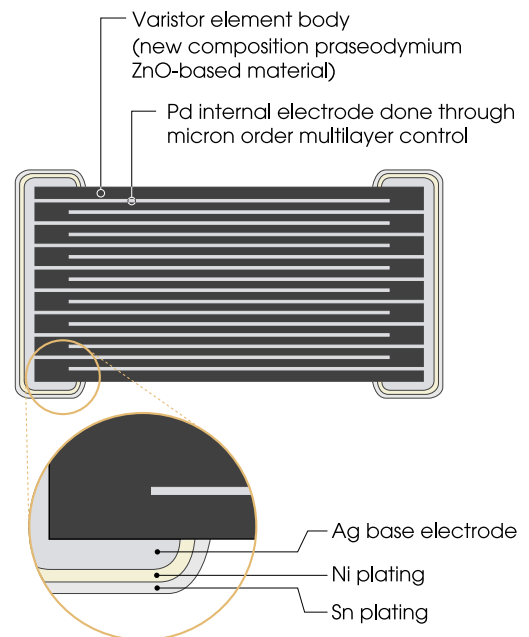

to become even smaller while improving absorption properties and stability.

To respond to those needs, TDK has supplied the miniature 0603 type and 2-element built-in array type. Here, while expanding 0603-type characteristic, TDK has developed two series to prevent the signal deterioration and to optimize the absorption property of surge noise and RF noise for high-speed interface. These are single-chip AVRL Series (1005 type/5 products, 1608 type/4 products) which can largely suppress the capacitance, and 2-line-in AVF16 Series (1608 type/2 products) which built-in 2 circuits of low varistor voltage element between I/O-terminal-connected inner conductor and GND terminal, to enable the applications of high-speed differential transmission signal lines.

These two new series can be used not only in a high-speed differential signal interface such as DVI, USB2.0, IEEE1394 which is mounted in PCs and the peripherals, but also in the Tx, Rx sides of the latest AV equipment such as STB, DVD recorder, digital TV, high-definition TV, LCD projector which include HDMI interface.

The needs for minimization and higher frequencies will further increase in the future. TDK will continue to focus on the two themes as our core projects and proactively launch new products to support designing next-generation devices as we continue to improve material characteristics and develop new materials.

Zinc-Oxide-Praseodymium based  
Multilayer Chip Varistors

# AVR-M, AVRL, AVF16 Series



## Product Lineup

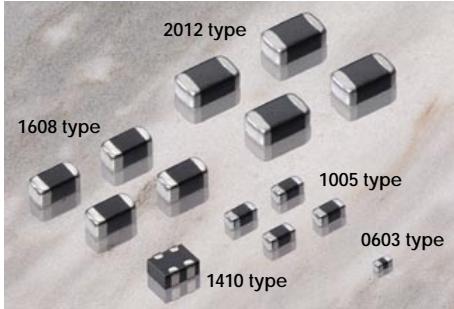

## AVR-M Series

0603/1005/1608/2012/1410 type

- The world's leading high-level absorption properties
- Strong product line that includes the world's smallest 1005 type and the state-of-the-art chip array 1410 type
- Exclusive zinc oxide praseodymium-based varistor that does not experience varistor voltage symmetrical deterioration
- Initial properties maintained even after electrostatic absorption
- Ag-based Ni+Sn plated terminal electrodes

Operating temperature range 0603: -40 to +85°C / 1005, 1608, 2012, 1410: -40 to +125°C

### Electrical characteristics

Part No.	Varistor voltage $V_{1mA}$ (V)	Maximum allowable circuit voltage $V_{dc}$ (V)	Clamp voltage $V_{cl}$ (8/20 $\mu$ s) (V)	Max. Energy E (10/1000 $\mu$ s) (Joule)	Surge current $I_p$ (8/20 $\mu$ s) (A)	Capacitance C (1kHz, 1Vrms) (pF)
<b>0603 type</b>						
AVR-M0603C6R8N□101N	6.8 (4.76 to 8.84)	3.5 max.	14 (1A)	0.01 max.	10 max.	100 typ.
AVR-M0603C080M□101N	8 (6.4 to 9.6)	5.5 max.	17 (1A)	0.01 max.	4 max.	100 typ.
AVR-M0603C120M□101N	12 (9.6 to 14.4)	7.5 max.	20 (1A)	0.01 max.	5 max.	100 typ.
AVR-M0603C120M□AAB	12 (9.6 to 14.4)	7.5 max.	23 (1A)	0.01 max.	1 max.	33 typ.
<b>1005 type</b>						
AVR-M1005C6R8N□101N	6.8 (4.76 to 8.84)	3.5 max.	14 (1A)	0.02 max.	10 max.	100 typ.
AVR-M1005C080M□AAB	8 (6.4 to 9.6)	5.5 max.	14 (1A)	0.04 max.	25 max.	650 typ.
AVR-M1005C080M□ADB	8 (6.4 to 9.6)	5.5 max.	14 (1A)	0.04 max.	25 max.	480 typ.
AVR-M1005C080M□ABB	8 (6.4 to 9.6)	5.5 max.	15 (1A)	0.02 max.	3 max.	100 typ.
AVR-M1005C080M□ACB	8 (6.4 to 9.6)	5.5 max.	19 (1A)	0.01 max.	1 max.	33 typ.
AVR-M1005C120M□AAB	12 (9.6 to 14.4)	7.5 max.	20 (1A)	0.05 max.	10 max.	130 typ.
AVR-M1005C270K□101N	27 (21.6 to 32.4)	19 max.	55 (1A)	0.06 max.	4 max.	100 typ.
AVR-M1005C270M□AAB	27 (21.6 to 32.4)	15 max.	50 (1A)	0.06 max.	4 max.	40 typ.
AVR-M1005C270M□ABB	27 (21.6 to 32.4)	15 max.	50 (1A)	0.05 max.	1 max.	15 typ.
<b>1608 type</b>						
AVR-M1608C080M□AAB	8 (6.4 to 9.6)	5.5 max.	15 (2A)	0.09 max.	30 max.	650 typ.
AVR-M1608C120M□6AB	12 (9.6 to 14.4)	7.5 max.	20 (2A)	0.09 max.	50 max.	1050 typ.
AVR-M1608C120M□2AB	12 (9.6 to 14.4)	7.5 max.	20 (2A)	0.06 max.	15 max.	400 typ.
AVR-M1608C180M□6AB	18 (14.4 to 21.6)	11 max.	30 (2A)	0.1 max.	30 max.	600 typ.
AVR-M1608C220K□6AB	22 (19.8 to 24.2)	16 max.	34 (2A)	0.1 max.	30 max.	560 typ.
AVR-M1608C220K□2AB	22 (19.8 to 24.2)	16 max.	37 (2A)	0.03 max.	10 max.	210 typ.
AVR-M1608C270K□6AB	27 (24 to 30)	19 max.	42 (2A)	0.1 max.	48 max.	430 typ.
AVR-M1608C270K□2AB	27 (24 to 30)	19 max.	42 (2A)	0.1 max.	20 max.	160 typ.
AVR-M1608C270M□ACB	27 (24 to 30)	19 max.	54 (2A)	0.05 max.	10 max.	60 typ.
AVR-M1608C270M□AAB	27 (21.6 to 32.4)	17 max.	52 (2A)	0.05 max.	2 max.	30 typ.
AVR-M1608C270M□ABB	27 (21.6 to 32.4)	17 max.	52 (2A)	0.05 max.	2 max.	15 typ.
AVR-M1608C390K□271N	39 (35 to 43)	28 max.	69 (2A)	0.1 max.	78 max.	270 typ.
<b>2012 type</b>						
AVR-M2012C120M□6AB	12 (9.6 to 14.4)	7.5 max.	20 (5A)	0.2 max.	60 max.	1000 typ.
AVR-M2012C220K□6AB	22 (19.8 to 24.2)	16 max.	38 (5A)	0.3 max.	100 max.	800 typ.
AVR-M2012C390K□6AB	39 (35 to 43)	28 max.	62 (5A)	0.3 max.	100 max.	430 typ.
<b>1410 type</b>						
AVR-M14A2C240M□600N	24 (20 to 27)	16 max.	50 (1A)	0.01 max.	5 max.	60 typ. (1MHz)
AVR-M14A2C270M□470N	27 (21.6 to 32.4)	15 max.	54 (1A)	0.007 max.	5 max.	47 typ. (1MHz)
AVR-M14A2C270M□150N	27 (21.6 to 32.4)	15 max.	55 (1A)	0.02 max.	3 max.	15 typ. (1MHz)
AVR-M14A2C270M□3R3F	27 (21.6 to 32.4)	10 max.	45 (0.2A)	0.002 max.	0.2 max.	3.3 typ. (1MHz)

The packaging type code T: taping / B: bulk is inserted in the □ space in the part number.

## Product Lineup

### Shapes and dimensions

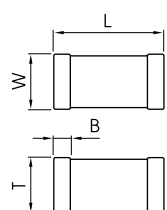

Dimensions in mm

Type	L	W	T	B	Weight (mg)
0603	$0.6 \pm 0.03$	$0.3 \pm 0.03$	$0.3 \pm 0.03$	0.1 min.	0.2 typ.
1005	$1 \pm 0.05$	$0.5 \pm 0.05$	$0.5 \pm 0.05$	0.1 min.	1.2 typ.
1608	$1.6 \pm 0.1$	$0.8 \pm 0.1$	$0.8 \pm 0.1$	0.2 min.	5 typ.
2012	$2 \pm 0.2$	$1.25 \pm 0.2$	$1 \pm 0.2$	0.2 min.	15 typ.

### Chip array 1410 type

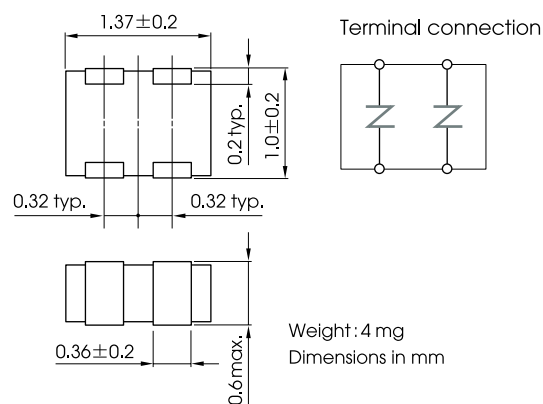

### Example of voltage vs. current characteristics

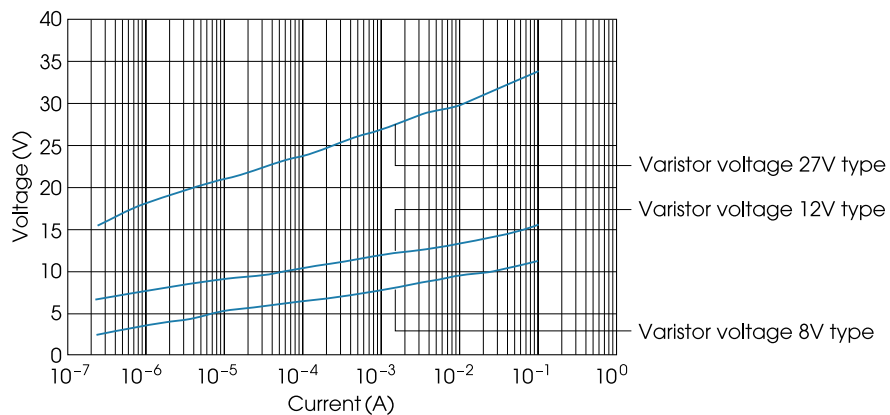



Zinc-Oxide-Praseodymium based  
Multilayer Chip Varistors

# AVR-M, AVRL, AVF16 Series



Low-Capacitance Type used in High-Speed Transmission Circuits

## AVRL Series

1005/1608 type

- Low-capacitance type optimized for high-speed transmission circuits such as HDMI, USB, and IEEE1394
- 1005- and 1608-type characteristic lineup which may correspond to various circuit specifications.
- Exclusive zinc oxide praseodymium-based varistor that does not experience varistor voltage symmetrical deterioration
- Initial properties maintained even after electrostatic absorption
- Ag-based Ni+Sn plated terminal electrodes

Operating temperature range: -40 to +85°C

### Electrical characteristics

Part No.	Capacitance C (1MHz, 1V <sub>rms</sub> ) (pF)	Maximum allowable circuit voltage V <sub>dc</sub> (V)	Insulation resistance R <sub>dc</sub> (3V <sub>rms</sub> ) (MΩ)	Varistor voltage V <sub>1mA</sub> (V)
<b>1005 type</b>				
AVRL101A1R1N□A	1.1 (0.8 to 1.4)	10 max.	10 min.	90 typ.
AVRL101A1R1N□B	1.1 (0.8 to 1.4)	10 max.	10 min.	39 typ.
AVRL101C2R2D□A	2.2 (1.7 to 2.7)	16 max.	10 min.	90 typ.
AVRL101A3R3F□A	3.3 (2.3 to 4.3)	10 max.	12 min.	27 typ.
AVRL101A6R8G□A	6.8 (4.8 to 8.8)	10 max.	13 min.	27 typ.
<b>1608 type</b>				
AVRL161A1R1N□A	1.1 (0.8 to 1.4)	10 max.	10 min.	90 typ.
AVRL161A1R1N□B	1.1 (0.8 to 1.4)	10 max.	10 min.	39 typ.
AVRL161A3R3F□A	3.3 (2.3 to 4.3)	10 max.	12 min.	27 typ.
AVRL161A6R8G□A	6.8 (4.8 to 8.8)	10 max.	13 min.	27 typ.

The packaging type code T: taping / B: bulk is inserted in the □ space in the part number.

### Shapes and dimensions

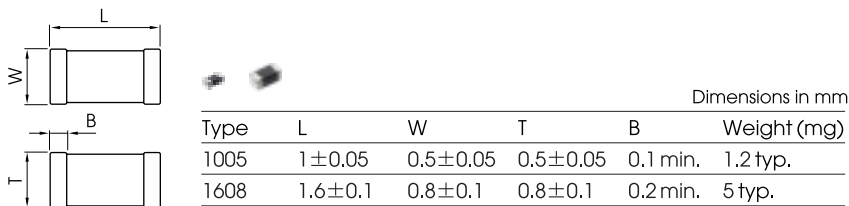



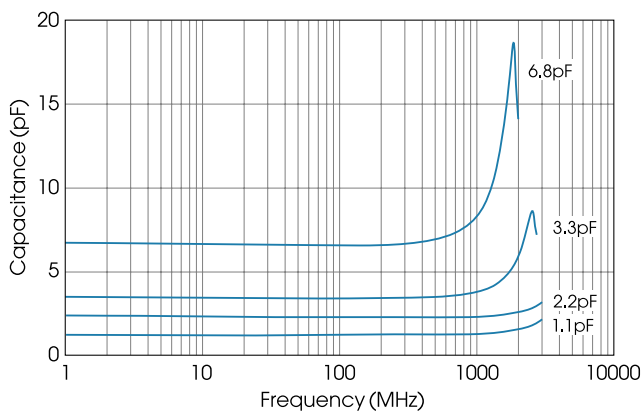







































### Capacitance vs. frequency characteristics



## Product Lineup

### AVR-M Series, AVRL Series

#### Product Lineup by Varistor Voltage

Varistor voltage $V_{1mA}$	Maximum allowable circuit voltage	Capacitance (1Vrms)	Shapes	Series		
<b>6.8V</b> typ.	3.5Vdc max.	100pF typ. (1kHz)	 0603	AVR-M		
			 1005	AVR-M		
		33pF typ. (1kHz)	 1005	AVR-M		
<b>8V</b> typ.	5.5Vdc max.	100pF typ. (1kHz)	 0603	AVR-M		
			 1005	AVR-M		
		480pF typ. (1kHz)	 1005	AVR-M		
			 1005	AVR-M		
		650pF typ. (1kHz)	 1608	AVR-M		
<b>12V</b> typ.	7.5Vdc max.	33pF typ. (1kHz)	 0603	AVR-M		
			 0603	AVR-M		
		100pF typ. (1kHz)	 1005	AVR-M		
		130pF typ. (1kHz)	 1005	AVR-M		
		400pF typ. (1kHz)	 1608	AVR-M		
		1000pF typ. (1kHz)	 2012	AVR-M		
<b>18V</b> typ.	11Vdc max.	1050pF typ. (1kHz)	 1608	AVR-M		
		600pF typ. (1kHz)	 1608	AVR-M		
		210pF typ. (1kHz)	 1608	AVR-M		
<b>22V</b> typ.	16Vdc max.	560pF typ. (1kHz)	 1608	AVR-M		
		800pF typ. (1kHz)	 2012	AVR-M		
<b>24V</b> typ.	16Vdc max.	60pF typ. (1MHz)	 1410	AVR-M		
			 1005	AVRL		
			 1608	AVRL		
			 1410	AVR-M		
			 1005	AVRL		
			 1608	AVRL		
		<b>27V</b> typ.	15Vdc max.	15pF typ. (1kHz)	 1005	AVR-M
					 1410	AVR-M
				40pF typ. (1kHz)	 1005	AVR-M
				47pF typ. (1MHz)	 1410	AVR-M
17Vdc max.		15pF typ. (1kHz)	 1608	AVR-M		
		30pF typ. (1kHz)	 1608	AVR-M		
		60pF typ. (1kHz)	 1608	AVR-M		
19Vdc max.		100pF typ. (1kHz)	 1005	AVR-M		
		160pF typ. (1kHz)	 1608	AVR-M		
		430pF typ. (1kHz)	 1608	AVR-M		
<b>39V</b> typ.	10Vdc max.	1.1 pF typ. (1kHz)	 1005	AVRL		
			 1608	AVRL		
	28Vdc max.	270pF typ. (1kHz)	 1608	AVR-M		
	430pF typ. (1kHz)	 2012	AVR-M			
<b>90V</b> typ.	10Vdc max.	1.1 pF typ. (1kHz)	 1005	AVRL		
	16Vdc max.	2.2pF typ. (1kHz)	 1608	AVRL		
			 1005	AVRL		

Zinc-Oxide-Praseodymium based  
Multilayer Chip Varistors

# AVR-M, AVRL, AVF16 Series



Low Varistor Voltage Type for High-Speed Differential Transmission Lines

## AVF16 Series

2-line-in 1608 type

- There are two varistor elements built in 1608 type. This is the best 2-line-in-1-chip optimized for high-speed differential transmission lines such as USB, IEEE1394, and HDMI.
- The cutoff(-3dB) frequency of differential mode (Sdd21) is over 2GHz.
- Exclusive zinc oxide praseodymium-based varistor that does not experience varistor voltage symmetrical deterioration
- By lowering the varistor voltage the outstanding ESD characteristic can be achieved.
- Meet ESD test IEC61000-4-2 HBM (human body model) 8kv contact
- Initial properties maintained even after electrostatic absorption
- Ag-based Ni+Sn plated terminal electrodes

Operating temperature range: -40 to +85°C

### Electrical characteristics

Part No.	Varistor voltage $V_{1mA}$ (V)	Maximum allowable circuit voltage $V_{dc}$ (V)	Cut-off frequency Sdd21 (GHz)
AVF16C212A000F205	12 typ.	5.5 max.	2 min.
AVF16C225A000F405	25 typ.	5.5 max.	4 min.

### Shapes and dimensions

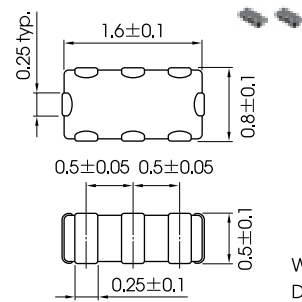

Weight : 3.9mg  
Dimensions in mm

### Insertion loss vs. frequency characteristic (Sdd21)

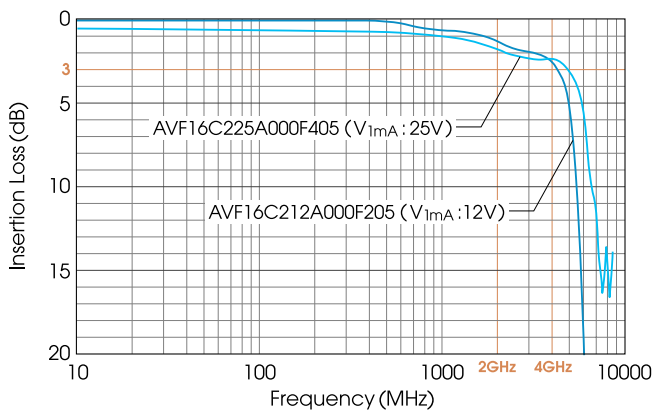

### Terminal connection

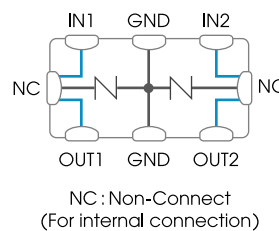

### Actual measurement example of characteristic impedance (TDR)

AVF16C225A000F405

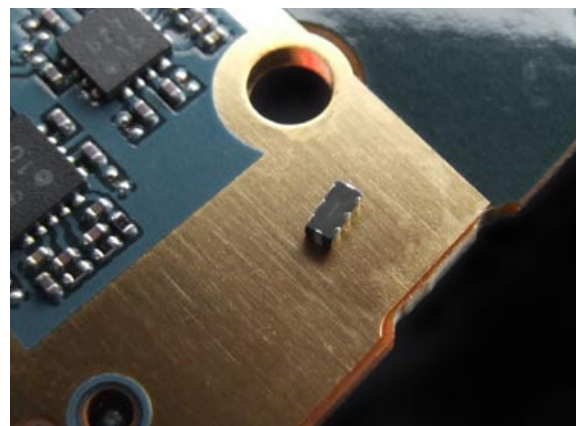
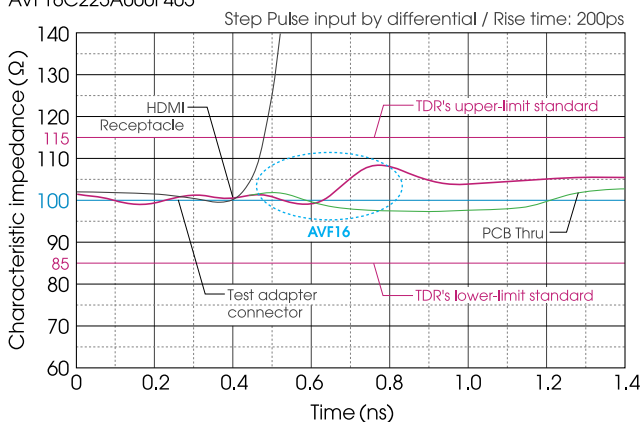

Example of application

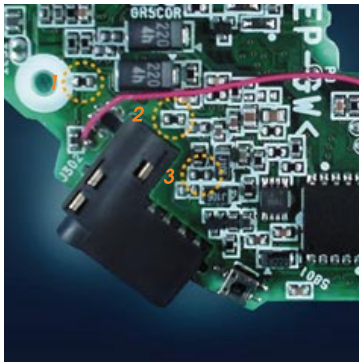

for Digital AV Player  
Application Circuit : Headphone Terminal

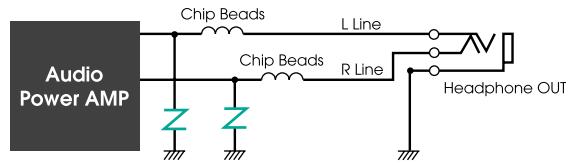

- 1,2 AVR-M1005C6R8NT101N
- 3 AVR-M1005C120MTAAB

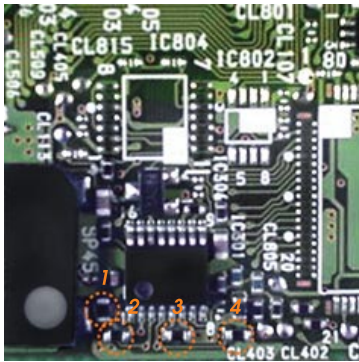

for PDA  
Application Circuit : LCD Touch Panel

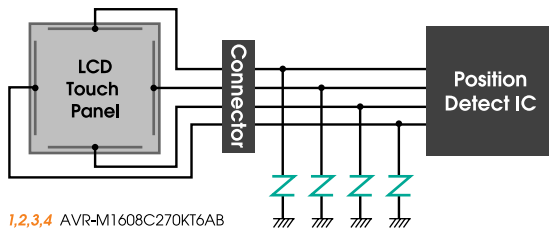

- 1,2,3,4 AVR-M1608C270KT6AB



for PDA  
Application Circuit : Push Button

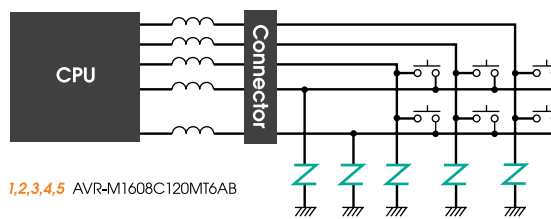

- 1,2,3,4,5 AVR-M1608C120MT6AB

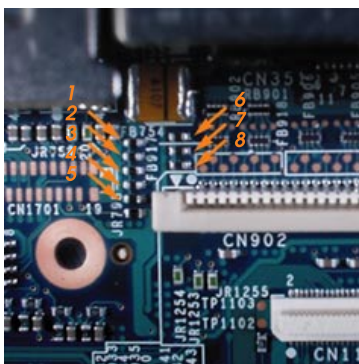

for Note PC  
Application Circuit : Keyboard Connector

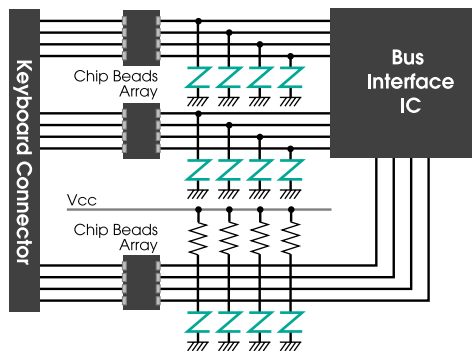

- 1,2,3,4,5,6,7,8 AVR-M1608C120MT2AB

Zinc-Oxide-Praseodymium based  
Multilayer Chip Varistors

# AVR-M, AVRL, AVF16 Series



for Digital / Analog Converter  
Application Circuit : Audio Out Lines

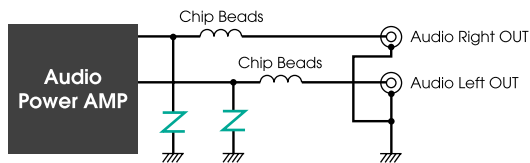

1,2,3,4,5,6,7,8,9,10,11 AVR-M1608C270KT6AB

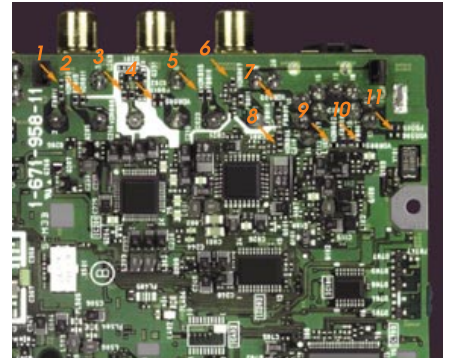

for Celluler Phone  
Application Circuit : Data Interface Connector

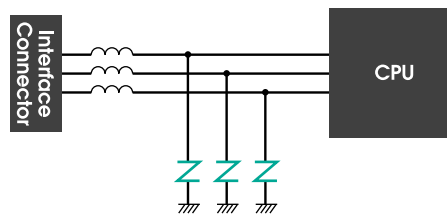

1 AVR-M1608C120MT2AB  
2,3 AVR-M1608C270KT2AB

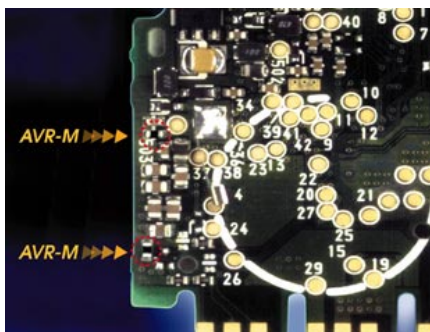
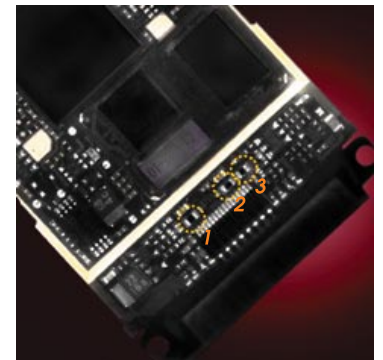

portable game machine

..... and for various types of electronic equipment

## Consumer appliances

Televisions	Input/output circuits (audio/video)
Audio systems	Input/output circuits
DVD, MD, CD players	Input/output circuits, remote control terminal
VCRs	Input/output circuits (audio/video)
Camcorders	Input/output circuits (audio/video)
Digital cameras	Interface component, buttons, LCD
Video game consoles	Input/output circuits (audio/video)
Personal Digital Assistant (PDAs)	Interface component, buttons, LCD

## Home appliances

Microwave ovens	Control panel
Electric rice cookers	Control panel
Air conditioners	Control panel
Telephones	Interface component, buttons, LCD, microphone, receiver

## Office appliances

Personal computers	Interface component, keyboard
HDDs	Interface component
CD-ROM, DVD-ROM players	Interface component
Plain paper copiers	Control panel interface
LBP/LED Printer	Interface component
Fax machines	Control panel interface

## Industrial machines

Industrial measuring meters	Control panel interface, buttons, LCD
-----------------------------	---------------------------------------

## Automobiles

ECUs	Interface component
Automotive LAN systems	Interface component
Motor circuits	Control circuit

## Others

Electronic toys	Buttons
Mobile phones Including Japanese PHS systems	Interface component, buttons, LCD, microphone, receiver