

MAX4249–MAX4257

UCSP, Single-Supply, Low-Noise, Low-Distortion, Rail-to-Rail Op Amps

General Description

The MAX4249–MAX4257 low-noise, low-distortion operational amplifiers offer rail-to-rail outputs and single-supply operation down to 2.4V. They draw 400 μ A of quiescent supply current per amplifier while featuring ultra-low distortion (0.0002% THD), as well as low input voltage-noise density (7.9nV/ $\sqrt{\text{Hz}}$) and low input current-noise density (0.5fA/ $\sqrt{\text{Hz}}$). These features make the devices an ideal choice for portable/battery-powered applications that require low distortion and/or low noise.

For additional power conservation, the MAX4249/MAX4251/MAX4253/MAX4256 offer a low-power shutdown mode that reduces supply current to 0.5 μ A and puts the amplifiers' outputs into a high-impedance state. The MAX4249–MAX4257's outputs swing rail-to-rail and their input common-mode voltage range includes ground. The MAX4250–MAX4254 are unity-gain stable with a gain-bandwidth product of 3MHz. The MAX4249/MAX4255/MAX4256/MAX4257 are internally compensated for gains of 10V/V or greater with a gain-bandwidth product of 22MHz. The single MAX4250/MAX4255 are available in space-saving 5-pin SOT23 packages. The MAX4252 is available in an 8-bump chip-scale package (UCSP™) and the MAX4253 is available in a 10-bump UCSP. The MAX4250AAUK comes in a 5-pin SOT23 package and is specified for operation over the automotive (-40°C to +125°C) temperature range.

Applications

Wireless Communications Devices
 PA Control
 Portable/Battery-Powered Equipment
 Medical Instrumentation
 ADC Buffers
 Digital Scales/Strain Gauges

Features

- ◆ Available in Space-Saving UCSP, SOT23, and μ MAX® Packages
- ◆ Low Distortion: 0.0002% THD (1k Ω load)
- ◆ 400 μ A Quiescent Supply Current per Amplifier
- ◆ Single-Supply Operation from 2.4V to 5.5V
- ◆ Input Common-Mode Voltage Range Includes Ground
- ◆ Outputs Swing Within 8mV of Rails with a 10k Ω Load
- ◆ 3MHz GBW Product, Unity-Gain Stable (MAX4250–MAX4254)
 22MHz GBW Product, Stable with $A_v \geq 10\text{V/V}$ (MAX4249/MAX4255/MAX4256/MAX4257)
- ◆ Excellent DC Characteristics
 $V_{OS} = 70\mu\text{V}$
 $I_{BIAS} = 1\text{pA}$
 Large-Signal Voltage Gain = 116dB
- ◆ Low-Power Shutdown Mode
 Reduces Supply Current to 0.5 μ A
 Places Outputs in a High-Impedance State
- ◆ 400pF Capacitive-Load Handling Capability

Ordering Information

| PART | TEMP RANGE | PIN-PACKAGE | TOP MARK |
|---------------|-----------------|--------------|----------|
| MAX4249ESD+ | -40°C to +85°C | 14 SO | — |
| MAX4249EUB+ | -40°C to +85°C | 10 μ MAX | — |
| MAX4250EUK+T | -40°C to +85°C | 5 SOT23 | ACCI |
| MAX4250AAUK+T | -40°C to +125°C | 5 SOT23 | AEYJ |

+ Denotes a lead(Pb)-free/RoHS-compliant package.
 T = Tape and reel.

Ordering Information continued at end of data sheet.
 Selector Guide appears at end of data sheet.

Pin/Bump Configurations

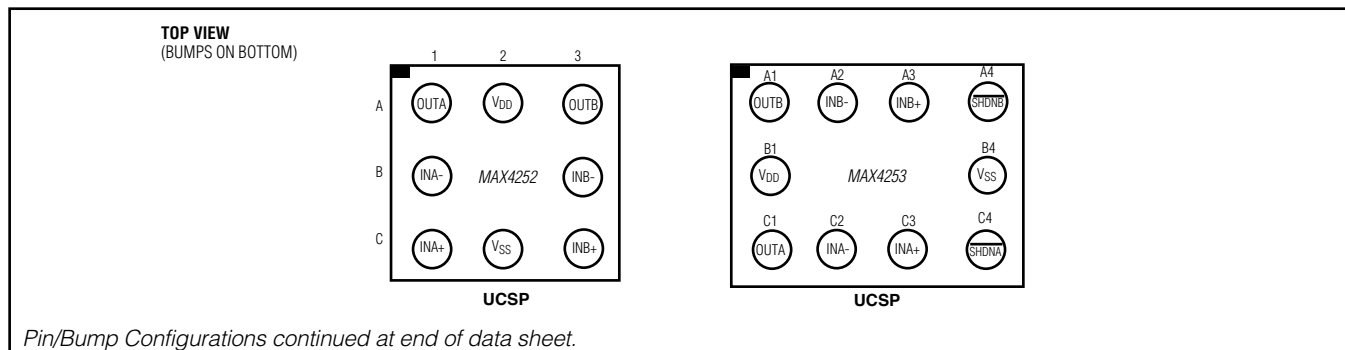

UCSP is a trademark and μ MAX is a registered trademark of Maxim Integrated Products, Inc.

For pricing, delivery, and ordering information, please contact Maxim Direct at 1-888-629-4642, or visit Maxim Integrated's website at www.maximintegrated.com.

MAX4249-MAX4257

UCSP, Single-Supply, Low-Noise, Low-Distortion, Rail-to-Rail Op Amps

ABSOLUTE MAXIMUM RATINGS

| | | | |
|--|---|--|----------------------|
| Power-Supply Voltage (V_{DD} to V_{SS}) |+6.0V to -0.3V | 10-Pin μ MAX (derate 5.6mW/°C above +70°C) |444mW |
| Analog Input Voltage (IN_+ , IN_-) |($V_{DD} + 0.3V$) to ($V_{SS} - 0.3V$) | 14-Pin SO (derate 8.33mW/°C above +70°C) |667mW |
| SHDN Input Voltage |6.0V to ($V_{SS} - 0.3V$) | Operating Temperature Range |-40°C to +85°C |
| Output Short-Circuit Duration to Either Supply |Continuous | MAX4250AAUK |-40°C to +125°C |
| Continuous Power Dissipation ($T_A = +70^\circ\text{C}$) | | Junction Temperature |+150°C |
| 5-Pin SOT23 (derate 7.1mW/°C above +70°C) |571mW | Storage Temperature Range |-65°C to +150°C |
| 8-Bump UCSP (derate 4.7mW/°C above +70°C) |379mW | Lead Temperature (soldering, 10s) |+300°C |
| 8-Pin μ MAX (derate 4.5mW/°C above +70°C) |362mW | Soldering Temperature (reflow) |+260°C |
| 8-Pin SO (derate 5.88mW/°C above +70°C) |471mW | | |
| 10-Bump UCSP (derate 6.1mW/°C above +70°C) |484mW | | |

Stresses beyond those listed under "Absolute Maximum Ratings" may cause permanent damage to the device. These are stress ratings only, and functional operation of the device at these or any other conditions beyond those indicated in the operational sections of the specifications is not implied. Exposure to absolute maximum rating conditions for extended periods may affect device reliability.

ELECTRICAL CHARACTERISTICS

($V_{DD} = 5V$, $V_{SS} = 0V$, $V_{CM} = 0V$, $V_{OUT} = V_{DD}/2$, R_L connected to $V_{DD}/2$, $\overline{SHDN} = V_{DD}$, $T_A = T_{MIN}$ to T_{MAX} , unless otherwise noted. Typical values are at $T_A = +25^\circ\text{C}$.) (Notes 2, 3)

| PARAMETER | SYMBOL | CONDITIONS | | MIN | TYP | MAX | UNITS | |
|--|------------|---|---|---------------|------------|----------------|------------------------------|-----|
| Supply Voltage Range | V_{DD} | (Note 4) | | 2.4 | | 5.5 | V | |
| Quiescent Supply Current Per Amplifier | I_Q | Normal mode | $V_{DD} = 3V$ | | 400 | | μA | |
| | | | $V_{DD} = 5V$ | E temperature | | 420 | | 575 |
| | | | | MAX4250AAUK | | | | 675 |
| | | $V_{DD} = 5V$, UCSP only | | 420 | 655 | | | |
| | | Shutdown mode ($\overline{SHDN} = V_{SS}$) (Note 2) | | | 0.5 | 1.5 | | |
| Input Offset Voltage (Note 5) | V_{OS} | E temperature | | | ± 0.07 | ± 0.75 | mV | |
| | | MAX4250AAUK | | | | ± 1.85 | | |
| Input Offset Voltage Tempco | TCV_{OS} | | | | 0.3 | | $\mu\text{V}/^\circ\text{C}$ | |
| Input Bias Current | I_B | (Note 6) | $T_A = +25^\circ\text{C}$ | | 0.1 | 1 | pA | |
| | | | $T_A = -40^\circ\text{C}$ to $+85^\circ\text{C}$ | | | 50 | | |
| | | | $T_A = -40^\circ\text{C}$ to $+125^\circ\text{C}$ | | | 1500 | | |
| Input Offset Current | I_{OS} | (Note 6) | $T_A = +25^\circ\text{C}$ | | 0.1 | 1 | pA | |
| | | | $T_A = -40^\circ\text{C}$ to $+85^\circ\text{C}$ | | | 10 | | |
| | | | $T_A = -40^\circ\text{C}$ to $+125^\circ\text{C}$ | | | 100 | | |
| Differential Input Resistance | R_{IN} | | | | 1000 | | $\text{G}\Omega$ | |
| Input Common-Mode Voltage Range | V_{CM} | Guaranteed by CMRR test | E temperature | -0.2 | | $V_{DD} - 1.1$ | V | |
| | | | MAX4250AAUK | 0 | | $V_{DD} - 1.1$ | | |
| Common-Mode Rejection Ratio | CMRR | $V_{SS} - 0.2V \leq V_{CM} \leq V_{DD} - 1.1V$ | E temperature | 70 | 115 | | dB | |
| | | | MAX4250AAUK | 68 | | | | |

MAX4249-MAX4257

UCSP, Single-Supply, Low-Noise, Low-Distortion, Rail-to-Rail Op Amps

ELECTRICAL CHARACTERISTICS (continued)

($V_{DD} = 5V$, $V_{SS} = 0V$, $V_{CM} = 0V$, $V_{OUT} = V_{DD}/2$, R_L connected to $V_{DD}/2$, $\overline{SHDN} = V_{DD}$, $T_A = T_{MIN}$ to T_{MAX} , unless otherwise noted. Typical values are at $T_A = +25^\circ C$.) (Notes 2, 3)

| PARAMETER | SYMBOL | CONDITIONS | | MIN | TYP | MAX | UNITS |
|----------------------------------|-----------------|--|-------------------|---------------------|-------|---------------------|-------------------|
| Power-Supply Rejection Ratio | PSRR | $V_{DD} - 2.4V$ to $5.5V$ | E temperature | 75 | 100 | | dB |
| | | | MAX4250AAUK | 72 | | | |
| Large-Signal Voltage Gain | A_v | $R_L = 10k\Omega$ to $V_{DD}/2$; $V_{OUT} = 25mV$ to $V_{DD} - 4.97V$ | E temperature | 80 | 116 | | dB |
| | | | MAX4250AAUK | 77 | | | |
| | | $R_L = 1k\Omega$ to $V_{DD}/2$; $V_{OUT} = 150V$ to $V_{DD} - 4.75V$ | E temperature | 80 | 112 | | |
| | | | MAX4250AAUK | 77 | | | |
| Output Voltage Swing | V_{OUT} | $ V_{IN+} - V_{IN-} \geq 10mV$; $R_L = 10k\Omega$ to $V_{DD}/2$ | $V_{DD} - V_{OH}$ | E | 8 | 25 | mV |
| | | | | A | | 30 | |
| | | | $V_{OL} - V_{SS}$ | E | 7 | 20 | |
| | | | | A | | 25 | |
| Output Voltage Swing | V_{OUT} | $ V_{IN+} - V_{IN-} \geq 10mV$; $R_L = 1k\Omega$ to $V_{DD}/2$ | $V_{DD} - V_{OH}$ | E | 77 | 200 | mV |
| | | | | A | | 225 | |
| | | | $V_{OL} - V_{SS}$ | E | 47 | 100 | |
| | | | | A | | 125 | |
| Output Short-Circuit Current | I_{SC} | | | 68 | | | mA |
| Output Leakage Current | I_{LEAK} | Shutdown mode ($\overline{SHDN} = V_{SS}$), $V_{OUT} = V_{SS}$ to V_{DD} (Note 2) | | | 0.001 | 1.0 | μA |
| \overline{SHDN} Logic Low | V_{IL} | (Note 2) | | | | $0.2 \times V_{DD}$ | V |
| \overline{SHDN} Logic High | V_{IH} | (Note 2) | | $0.8 \times V_{DD}$ | | | V |
| \overline{SHDN} Input Current | I_{IL}/I_{IH} | $\overline{SHDN} = V_{SS} = V_{DD}$ (Note 2) | | | 0.5 | 1.5 | μA |
| Input Capacitance | | | | | 11 | | pF |
| Gain-Bandwidth Product | GBW | MAX4250-MAX4254 | | | 3 | | MHz |
| | | MAX4249/MAX4255/MAX4256/MAX4257 | | | 22 | | |
| Slew Rate | SR | MAX4250-MAX4254 | | | 0.3 | | V/ μs |
| | | MAX4249/MAX4255/MAX4256/MAX4257 | | | 2.1 | | |
| Peak-to-Peak Input-Noise Voltage | e_{np-p} | $f = 0.1Hz$ to $10Hz$ | | | 760 | | nV _{P-P} |
| Input Voltage-Noise Density | e_n | $f = 10Hz$ | | | 27 | | nV/ \sqrt{Hz} |
| | | $f = 1kHz$ | | | 8.9 | | |
| | | $f = 30kHz$ | | | 7.9 | | |
| Input Current-Noise Density | i_n | $f = 1kHz$ | | | 0.5 | | fA/ \sqrt{Hz} |

MAX4249–MAX4257

UCSP, Single-Supply, Low-Noise, Low-Distortion, Rail-to-Rail Op Amps

ELECTRICAL CHARACTERISTICS (continued)

($V_{DD} = 5V$, $V_{SS} = 0V$, $V_{CM} = 0V$, $V_{OUT} = V_{DD}/2$, R_L connected to $V_{DD}/2$, $\overline{SHDN} = V_{DD}$, $T_A = T_{MIN}$ to T_{MAX} , unless otherwise noted. Typical values are at $T_A = +25^\circ C$.) (Notes 2, 3)

| PARAMETER | SYMBOL | CONDITIONS | | MIN | TYP | MAX | UNITS |
|--------------------------------------|----------|--|-------------------------------------|-----|--------|-----|---------|
| Total Harmonic Distortion Plus Noise | THD+N | MAX4250–MAX4254 $A_V = 1V/V$, $V_{OUT} = 2V_{P-P}$, $R_L = 1k\Omega$ to GND (Note 7) | $f = 1kHz$ | | 0.0004 | | % |
| | | | $f = 20kHz$ | | 0.006 | | |
| | | MAX4249/MAX4255/ MAX4256/MAX4257 $A_V = 1V/V$, $V_{OUT} = 2V_{P-P}$, $R_L = 1k\Omega$ to GND (Note 7) | $f = 1kHz$ | | 0.0012 | | |
| | | | $f = 20kHz$ | | 0.007 | | |
| Capacitive-Load Stability | | No sustained oscillations | | | 400 | | pF |
| Gain Margin | GM | MAX4250–MAX4254, $A_V = 1V/V$ | | | 10 | | dB |
| | | MAX4249/MAX4255/MAX4256/MAX4257, $A_V = 10V/V$ | | | 12.5 | | |
| Phase Margin | Φ_M | MAX4250–MAX4254, $A_V = 1V/V$ | | | 74 | | Degrees |
| | | MAX4249/MAX4255/MAX4256/MAX4257, $A_V = 10V/V$ | | | 68 | | |
| Settling Time | | To 0.01%, $V_{OUT} = 2V$ step | MAX4250–MAX4254 | | 6.7 | | μs |
| | | | MAX4249/MAX4255/ MAX4256/MAX4257 | | 1.6 | | |
| Delay Time to Shutdown | t_{SH} | $V_{DD} = 5\%$ of normal operation | MAX4251/MAX4253 | | 0.8 | | μs |
| | | | MAX4249/MAX4256 | | 1.2 | | |
| Delay Time to Enable | t_{EN} | $V_{OUT} = 2.5V$, V_{OUT} settles to 0.1% | MAX4251/MAX4253 | | 8 | | μs |
| | | | MAX4249/MAX4256 | | 3.5 | | |
| Power-Up Delay Time | t_{PU} | $V_{DD} = 0$ to $5V$ step, V_{OUT} stable to 0.1% | | | 6 | | μs |

Note 2: \overline{SHDN} is available on the MAX4249/MAX4251/MAX4253/MAX4256 only.

Note 3: All device specifications are 100% tested at $T_A = +25^\circ C$. Limits over temperature are guaranteed by design.

Note 4: Guaranteed by the PSRR test.

Note 5: Offset voltage prior to reflow on the UCSP.

Note 6: Guaranteed by design.

Note 7: Lowpass-filter bandwidth is 22kHz for $f = 1kHz$ and 80kHz for $f = 20kHz$. Noise floor of test equipment = $10nV/\sqrt{Hz}$.

MAX4249-MAX4257

UCSP, Single-Supply, Low-Noise, Low-Distortion, Rail-to-Rail Op Amps

Typical Operating Characteristics

($V_{DD} = 5V$, $V_{SS} = 0V$, $V_{CM} = V_{OUT} = V_{DD}/2$, input noise floor of test equipment = $10nV/\sqrt{Hz}$ for all distortion measurements, $T_A = +25^\circ C$, unless otherwise noted.)

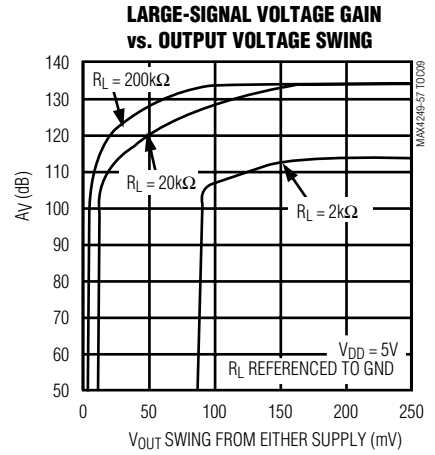
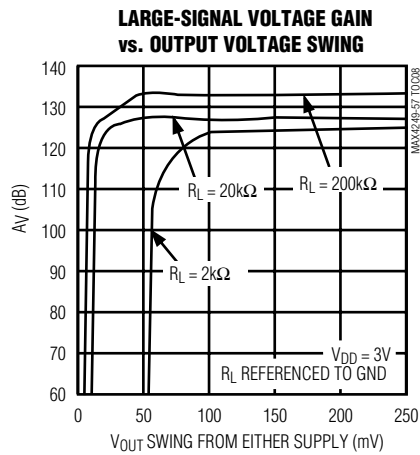
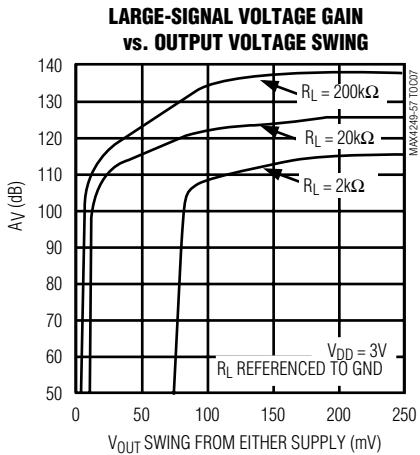
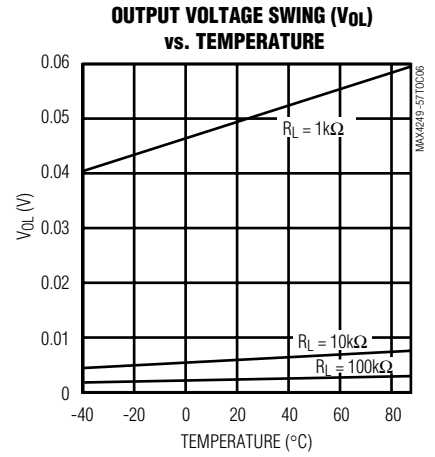
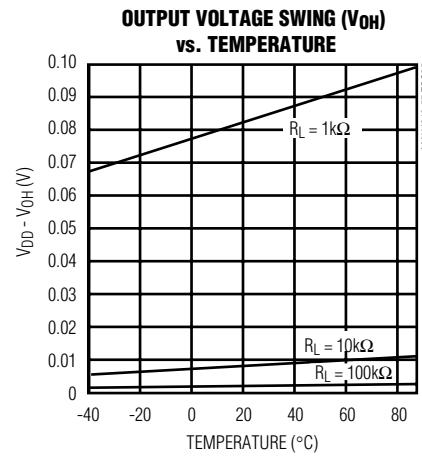
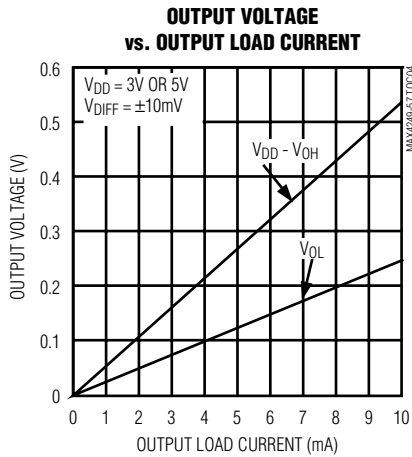
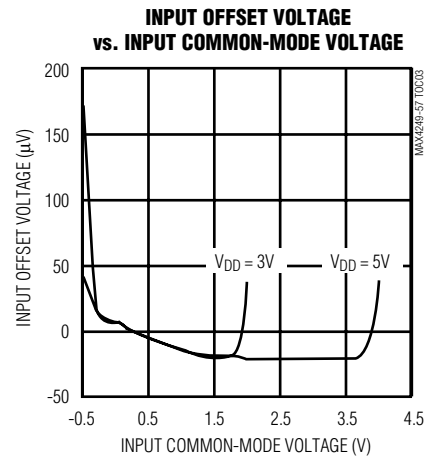
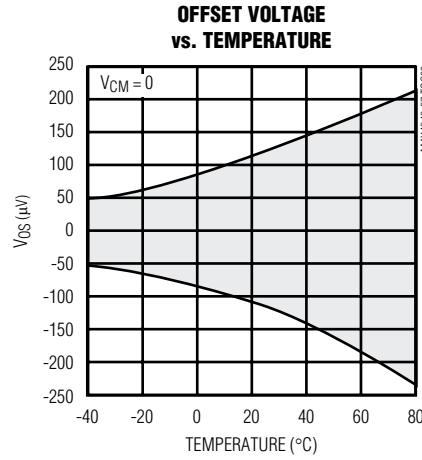
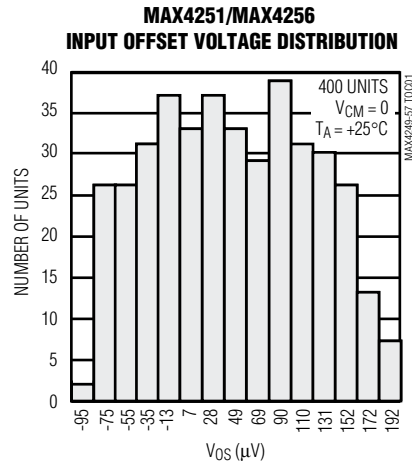

MAX4249-MAX4257

UCSP, Single-Supply, Low-Noise, Low-Distortion, Rail-to-Rail Op Amps

Typical Operating Characteristics (continued)

($V_{DD} = 5V$, $V_{SS} = 0V$, $V_{CM} = V_{OUT} = V_{DD}/2$, input noise floor of test equipment = $10nV/\sqrt{Hz}$ for all distortion measurements, $T_A = +25^\circ C$, unless otherwise noted.)

LARGE-SIGNAL VOLTAGE GAIN vs. OUTPUT VOLTAGE SWING

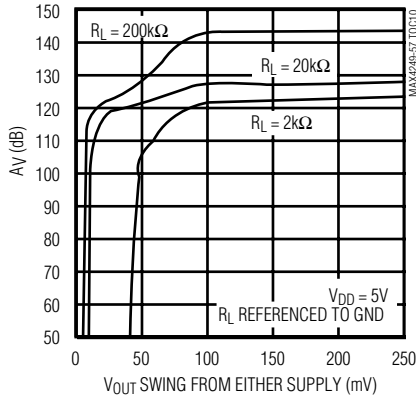

LARGE-SIGNAL VOLTAGE GAIN vs. TEMPERATURE

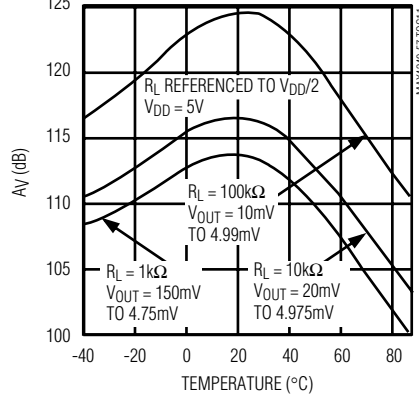

SUPPLY CURRENT AND SHUTDOWN SUPPLY CURRENT vs. TEMPERATURE

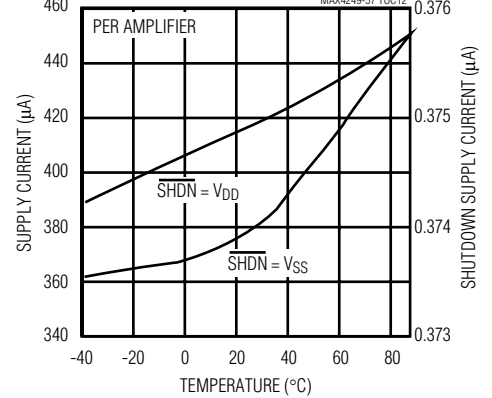

SUPPLY CURRENT AND SHUTDOWN SUPPLY CURRENT vs. SUPPLY VOLTAGE

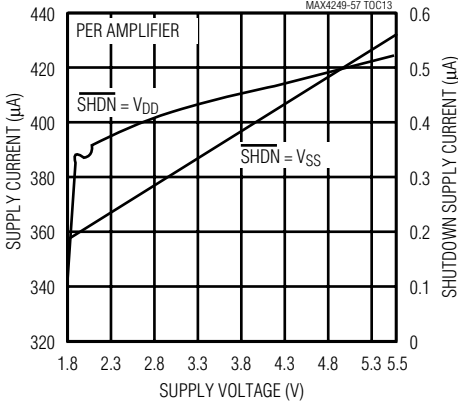

SUPPLY CURRENT vs. OUTPUT VOLTAGE

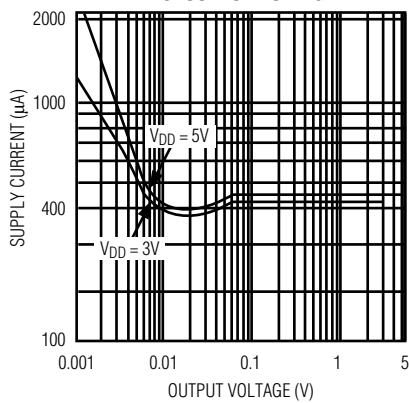

INPUT OFFSET VOLTAGE vs. SUPPLY VOLTAGE

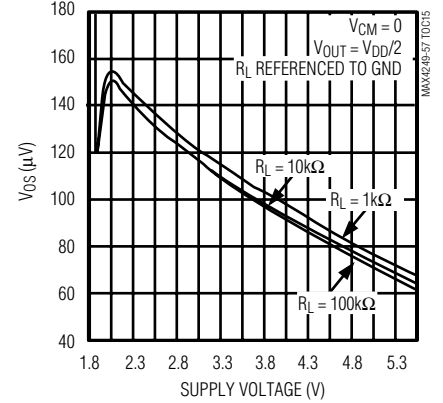

MAX4250-MAX4254 GAIN AND PHASE vs. FREQUENCY

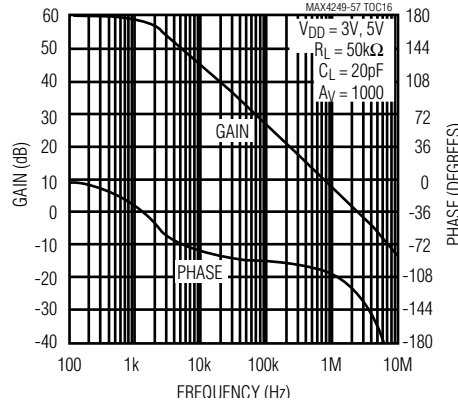

MAX4249/MAX4255/MAX4256/MAX4257 GAIN AND PHASE vs. FREQUENCY

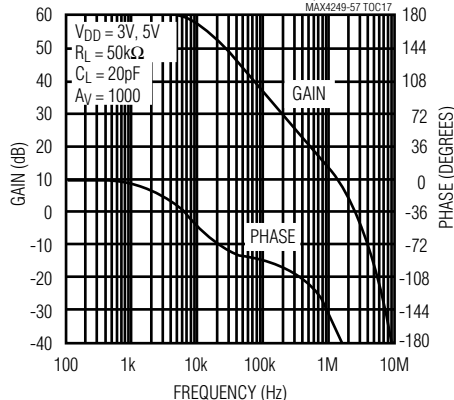

MAX4250-MAX4254 POWER-SUPPLY REJECTION RATIO vs. FREQUENCY

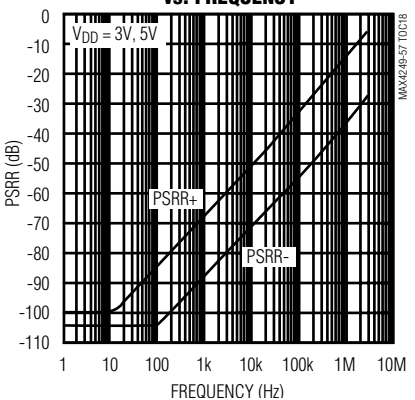

MAX4249-MAX4257

UCSP, Single-Supply, Low-Noise, Low-Distortion, Rail-to-Rail Op Amps

Typical Operating Characteristics (continued)

($V_{DD} = 5V$, $V_{SS} = 0V$, $V_{CM} = V_{OUT} = V_{DD}/2$, input noise floor of test equipment = $10nV/\sqrt{Hz}$ for all distortion measurements, $T_A = +25^\circ C$, unless otherwise noted.)

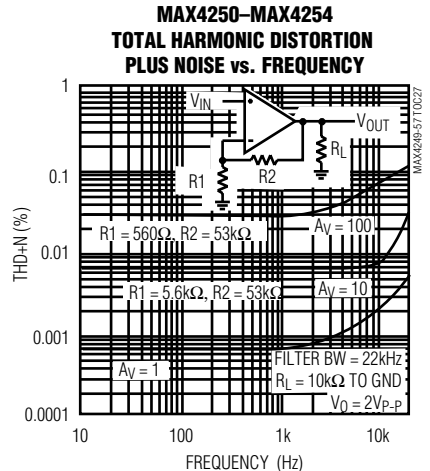
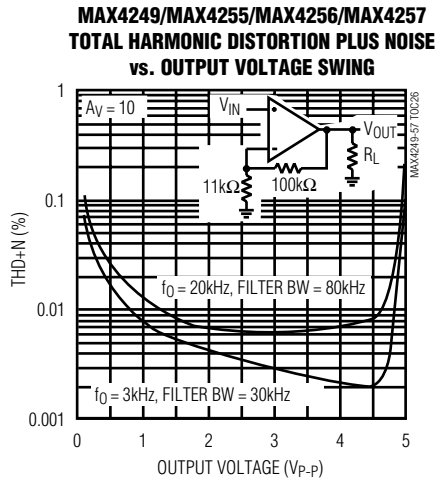
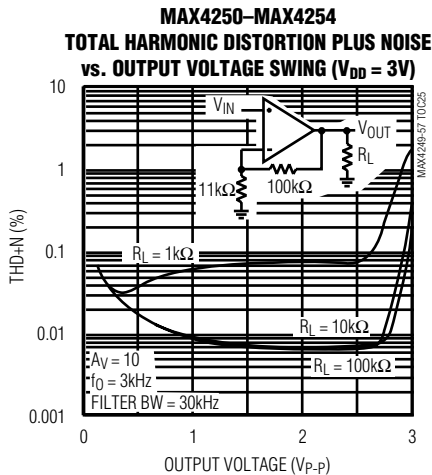
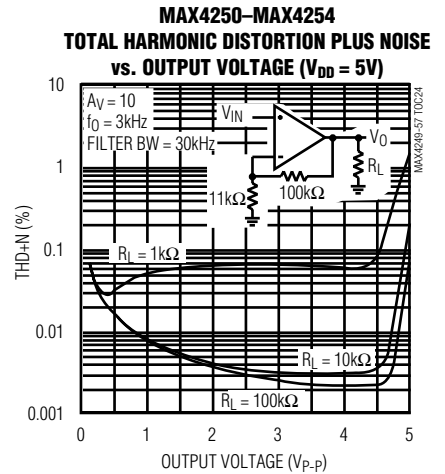
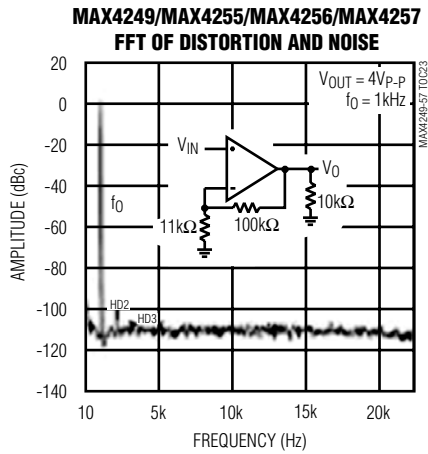
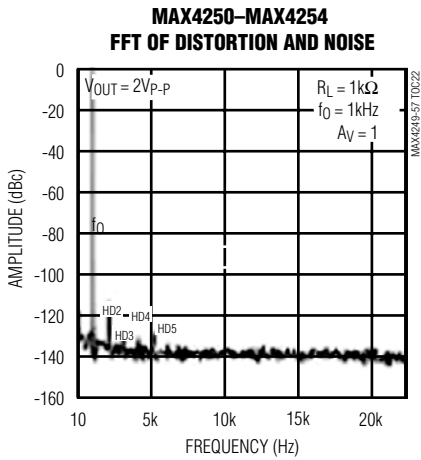
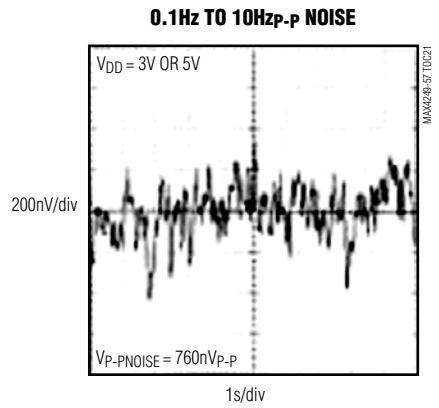
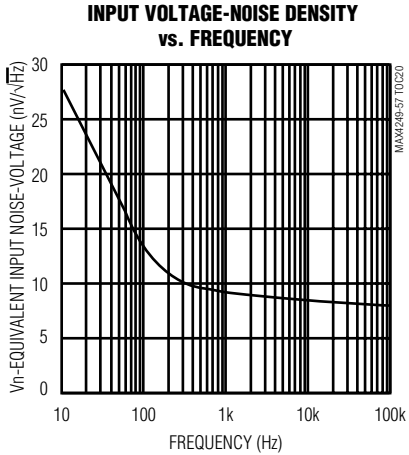
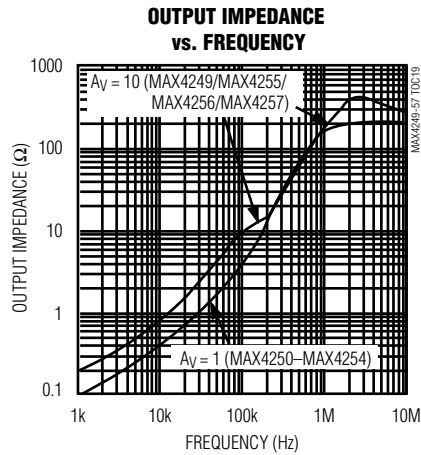

MAX4249-MAX4257

UCSP, Single-Supply, Low-Noise, Low-Distortion, Rail-to-Rail Op Amps

Typical Operating Characteristics (continued)

($V_{DD} = 5V$, $V_{SS} = 0V$, $V_{CM} = V_{OUT} = V_{DD}/2$, input noise floor of test equipment = $10nV/\sqrt{Hz}$ for all distortion measurements, $T_A = +25^\circ C$, unless otherwise noted.)

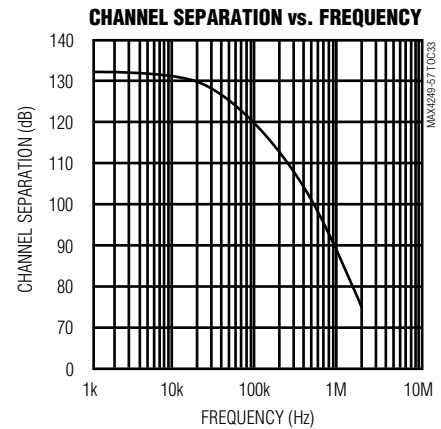
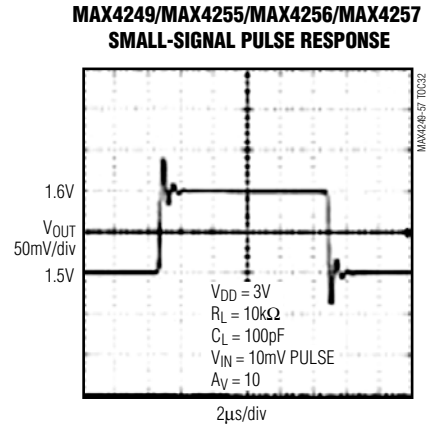
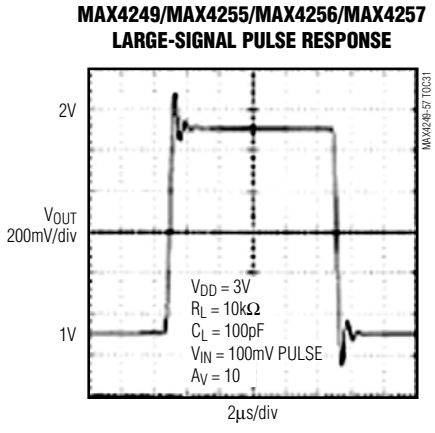
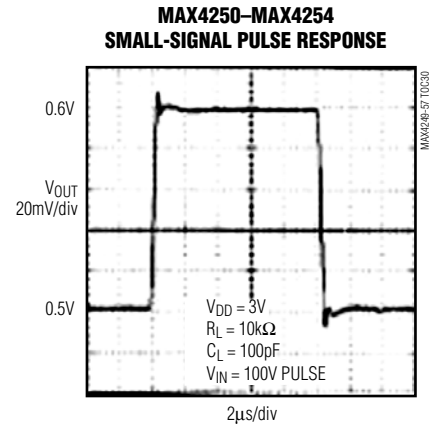
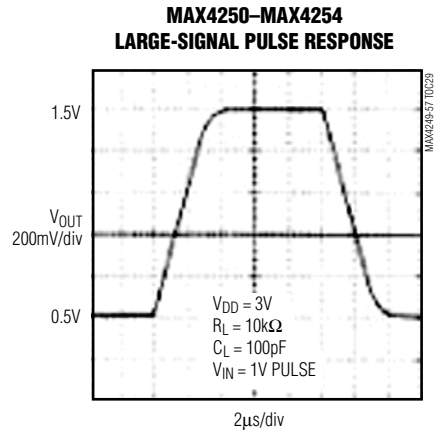
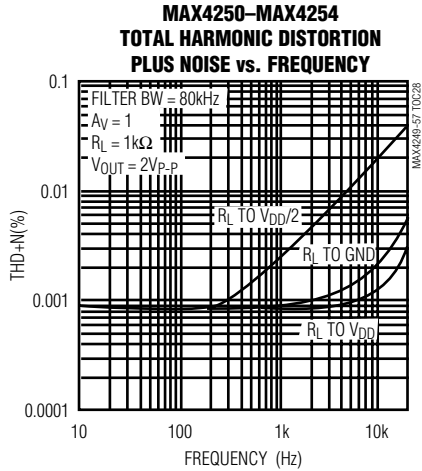

MAX4249–MAX4257

UCSP, Single-Supply, Low-Noise, Low-Distortion, Rail-to-Rail Op Amps

Pin/Bump Description

| PIN/BUMP | | | | | | | | NAME | FUNCTION |
|---------------------|------------------------|------------------------|----------------|---------------------|---------------------|----------------|-----------------|---|--|
| MAX4250/ MAX4255 | MAX4251/ MAX4256 | MAX4252/ MAX4257 | MAX4252 | MAX4249/ MAX4253 | | | MAX4254 | | |
| 5-PIN SOT23 | 8-PIN SO/ μ MAX | 8-PIN SO/ μ MAX | 8-BUMP UCSP | 10-BUMP UCSP | 10-PIN μ MAX | 14-PIN SO | 14-PIN SO | | |
| 1 | 6 | 1, 7 | A1, A3 | A1, C1 | 1, 9 | 1, 13 | 1, 7, 8, 14 | OUT, OUTA, OUTB, OUTC, OUTD | Amplifier Output |
| 2 | 4 | 4 | C2 | B4 | 4 | 4 | 11 | V _{SS} | Negative Supply. Connect to ground for single- supply operation |
| 3 | 3 | 3, 5 | C1, C3 | A3, C3 | 3, 7 | 3, 11 | 3, 5, 10, 12 | IN+, INA+, INB+, INC+, IND+ | Noninverting Amplifier Input |
| 4 | 2 | 2, 6 | B1, B3 | A2, C2 | 2, 8 | 2, 12 | 2, 6, 9, 13 | IN-, INA-, INB-, INC-, IND- | Inverting Amplifier Input |
| 5 | 7 | 8 | A2 | B1 | 10 | 14 | 4 | V _{DD} | Positive Supply |
| — | 8 | — | — | A4, C4 | 5, 6 | 6, 9 | — | $\overline{\text{SHDN}}$, SHDNA, SHDNB | Shutdown Input, Connect to V _{DD} or leave unconnected for normal operation (amplifier(s) enabled). |
| — | 1, 5 | — | — | — | — | 5, 7, 8, 10 | — | N.C. | No Connection. Not internally connected. |
| — | — | — | B2 | B2, B3 | — | — | — | — | Not populated with solder sphere |

Detailed Description

The MAX4249–MAX4257 single-supply operational amplifiers feature ultra-low noise and distortion while consuming very little power. Their low distortion and low noise make them ideal for use as preamplifiers in wide dynamic-range applications, such as 16-bit analog-to-digital converters (see *Typical Operating Circuit*). Their high-input impedance and low noise are also useful for signal conditioning of high-impedance sources, such as piezoelectric transducers.

These devices have true rail-to-rail output operation, drive loads as low as 1k Ω while maintaining DC accuracy,

and can drive capacitive loads up to 400pF without oscillation. The input common-mode voltage range extends from V_{DD} - 1.1V to 200mV beyond the negative rail. The push-pull output stage maintains excellent DC characteristics, while delivering up to \pm 5mA of current.

The MAX4250–4254 are unity-gain stable, whereas, the MAX4249/MAX4255/MAX4256/MAX4257 have a higher slew rate and are stable for gains \geq 10V/V. The MAX4249/MAX4251/MAX4253/MAX4256 feature a low-power shutdown mode, which reduces the supply current to 0.5 μ A and disables the outputs.

The MAX4250AAUK is specified for operation over the automotive (-40°C to +125°C) temperature range.

MAX4249-MAX4257

UCSP, Single-Supply, Low-Noise, Low-Distortion, Rail-to-Rail Op Amps

Low Distortion

Many factors can affect the noise and distortion that the device contributes to the input signal. The following guidelines offer valuable information on the impact of design choices on Total Harmonic Distortion (THD).

Choosing proper feedback and gain resistor values for a particular application can be a very important factor in reducing THD. In general, the smaller the closed-loop gain, the smaller the THD generated, especially when driving heavy resistive loads. Large-value feedback resistors can significantly improve distortion. The THD of the part normally increases at approximately 20dB per decade, as a function of frequency. Operating the device near or above the full-power bandwidth significantly degrades distortion.

Referencing the load to either supply also improves the part's distortion performance, because only one of the MOSFETs of the push-pull output stage drives the output. Referencing the load to midsupply increases the part's distortion for a given load and feedback setting. (See the Total Harmonic Distortion vs. Frequency graph in the *Typical Operating Characteristics*.)

For gains $\geq 10V/V$, the decompensated devices MAX4249/MAX4255/MAX4256/MAX4257 deliver the best distortion performance, since they have a higher slew rate and provide a higher amount of loop gain for a given closed-loop gain setting. Capacitive loads below 400pF, do not significantly affect distortion results. Distortion performance remains relatively constant over supply voltages.

Low Noise

The amplifier's input-referred, noise-voltage density is dominated by flicker noise at lower frequencies, and by thermal noise at higher frequencies. Because the thermal noise contribution is affected by the parallel combination of the feedback resistive network ($R_F \parallel R_G$, Figure 1), these resistors should be reduced in cases where the system bandwidth is large and thermal noise is dominant. This noise contribution factor decreases, however, with increasing gain settings.

For example, the input noise-voltage density of the circuit with $R_F = 100k\Omega$, $R_G = 11k\Omega$ ($A_V = 10V/V$) is $e_n = 15nV/\sqrt{Hz}$, e_n can be reduced to $9nV/\sqrt{Hz}$ by choosing $R_F = 10k\Omega$, $R_G = 1.1k\Omega$ ($A_V = 10V/V$), at the expense of greater current consumption and potentially higher distortion. For a gain of $100V/V$ with $R_F = 100k\Omega$, $R_G = 1.1k\Omega$, the e_n is low ($9nV/\sqrt{Hz}$).

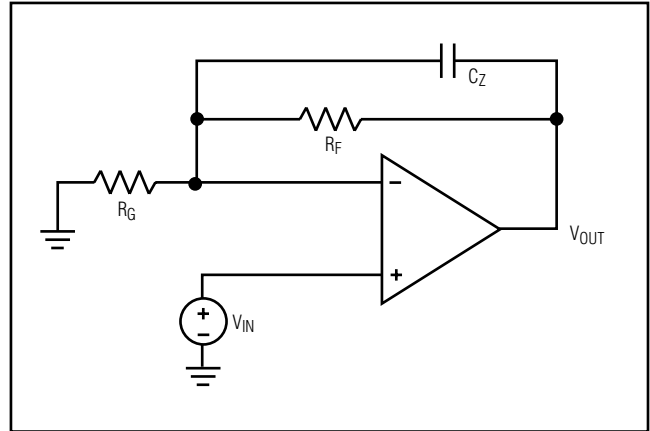

Figure 1. Adding Feed-Forward Compensation

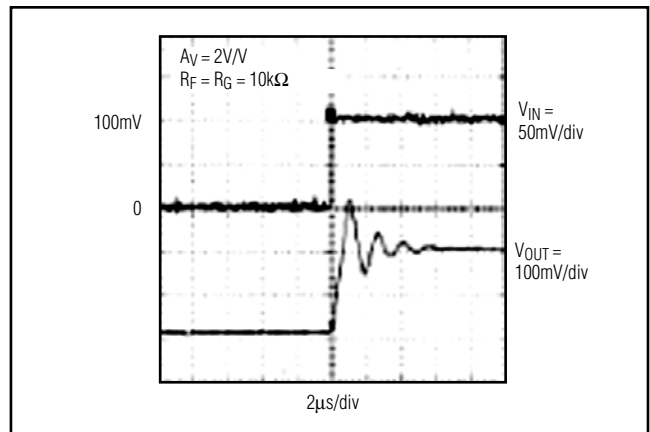

Figure 2a. Pulse Response with No Feed-Forward Compensation

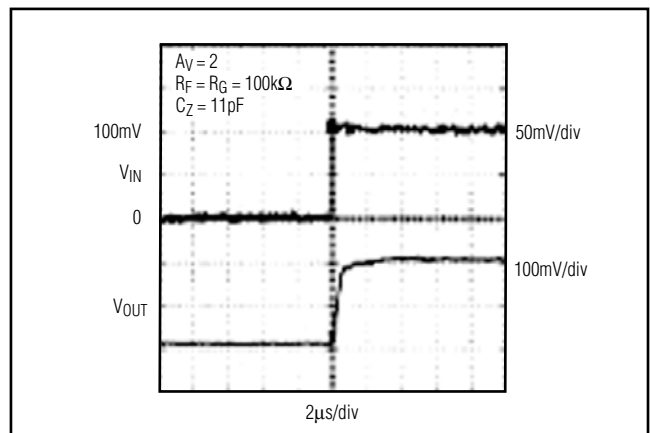

Figure 2b. Pulse Response with 10pF Feed-Forward Compensation

MAX4249–MAX4257

UCSP, Single-Supply, Low-Noise, Low-Distortion, Rail-to-Rail Op Amps

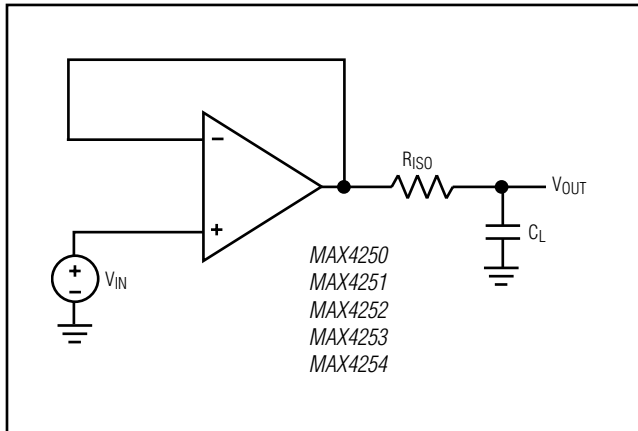

Figure 3. Overdriven Input Showing No Phase Reversal

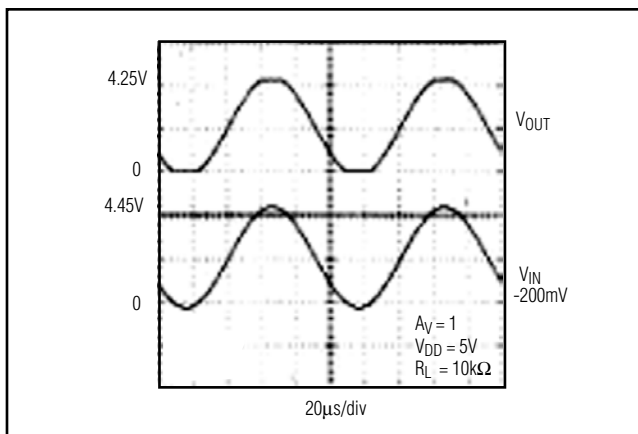

Figure 4. Rail-to-Rail Output Operation

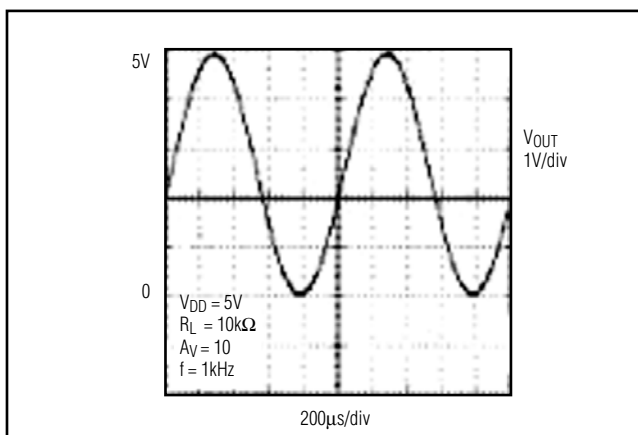

Figure 5. Capacitive-Load Driving Circuit

Using a Feed-Forward Compensation Capacitor, C_Z

The amplifier's input capacitance is 11pF. If the resistance seen by the inverting input is large (feedback network), this can introduce a pole within the amplifier's bandwidth, resulting in reduced phase margin. Compensate the reduced phase margin by introducing a feed-forward capacitor (C_Z) between the inverting input and the output (Figure 1). This effectively cancels the pole from the inverting input of the amplifier. Choose the value of C_Z as follows:

$$C_Z = 11 \times (R_F / R_G) \text{ [pF]}$$

In the unity-gain stable MAX4250–MAX4254, the use of a proper C_Z is most important for $A_V = 2V/V$, and $A_V = -1V/V$. In the decompensated MAX4249/MAX4255/MAX4256/MAX4257, C_Z is most important for $A_V = 10V/V$. Figures 2a and 2b show transient response both with and without C_Z .

Using a slightly smaller C_Z than suggested by the formula above achieves a higher bandwidth at the expense of reduced phase and gain margin. As a general guideline, consider using C_Z for cases where $R_G \parallel R_F$ is greater than 20k Ω (MAX4250–MAX4254) or greater than 5k Ω (MAX4249/MAX4255/MAX4256/MAX4257).

Applications Information

The MAX4249–MAX4257 combine good driving capability with ground-sensing input and rail-to-rail output operation. With their low distortion, low noise, and low-power consumption, these devices are ideal for use in portable instrumentation systems and other low-power, noise-sensitive applications.

Ground-Sensing and Rail-to-Rail Outputs

The common-mode input range of these devices extends below ground, and offers excellent common-mode rejection. These devices are guaranteed not to undergo phase reversal when the input is overdriven (Figure 3).

Figure 4 showcases the true rail-to-rail output operation of the amplifier, configured with $A_V = 10V/V$. The output swings to within 8mV of the supplies with a 10k Ω load, making the devices ideal in low-supply-voltage applications.

Output Loading and Stability

Even with their low quiescent current of 400 μ A, these amplifiers can drive 1k Ω loads while maintaining excellent DC accuracy. Stability while driving heavy capacitive loads is another key feature.

MAX4249–MAX4257

UCSP, Single-Supply, Low-Noise, Low-Distortion, Rail-to-Rail Op Amps

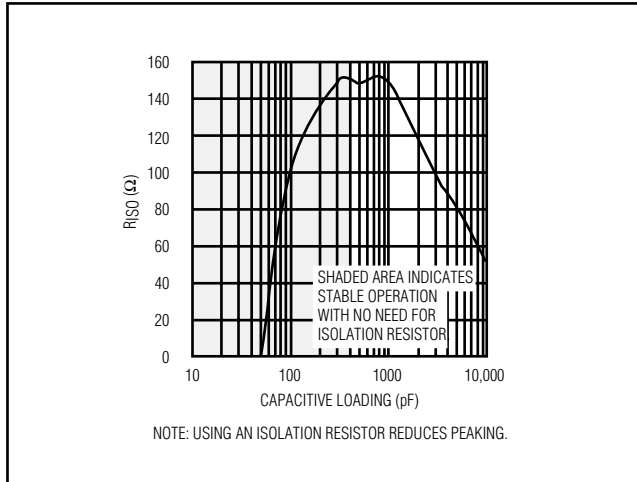

Figure 6. Isolation Resistance vs. Capacitive Loading to Minimize Peaking (<2dB)

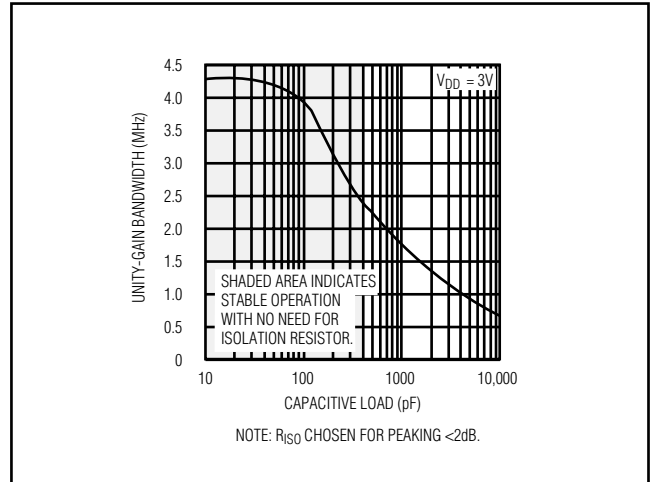

Figure 8. MAX4250–MAX4254 Unity-Gain Bandwidth vs. Capacitive Load

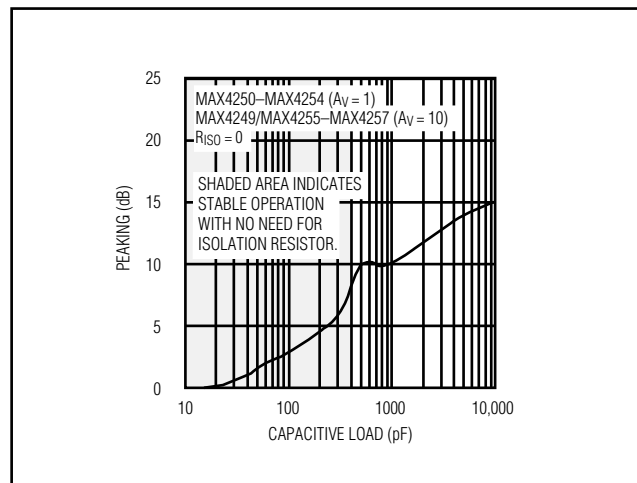

Figure 7. Peaking vs. Capacitive Load

These devices maintain stability while driving loads up to 400pF. To drive higher capacitive loads, place a small isolation resistor in series between the output of the amplifier and the capacitive load (Figure 5). This resistor improves the amplifier’s phase margin by isolating the capacitor from the op amp’s output. Reference Figure 6 to select a resistance value that will ensure a load capacitance that limits peaking to <2dB (25%). For example, if the capacitive load is 1000pF, the corresponding isolation resistor is 150Ω. Figure 7 shows that peaking occurs without the isolation resistor. Figure 8 shows the unity-gain bandwidth vs. capacitive load for the MAX4250–MAX4254.

Power Supplies and Layout

The MAX4249–MAX4257 operate from a single 2.4V to 5.5V power supply or from dual supplies of ±1.20V to ±2.75V. For single-supply operation, bypass the power supply with a 0.1μF ceramic capacitor placed close to the V_{DD} pin. If operating from dual supplies, bypass each supply to ground.

Good layout improves performance by decreasing the amount of stray capacitance and noise at the op amp’s inputs and output. To decrease stray capacitance, minimize PC board trace lengths and resistor leads, and place external components close to the op amp’s pins.

MAX4249–MAX4257

UCSP, Single-Supply, Low-Noise, Low-Distortion, Rail-to-Rail Op Amps

Typical Operating Circuit

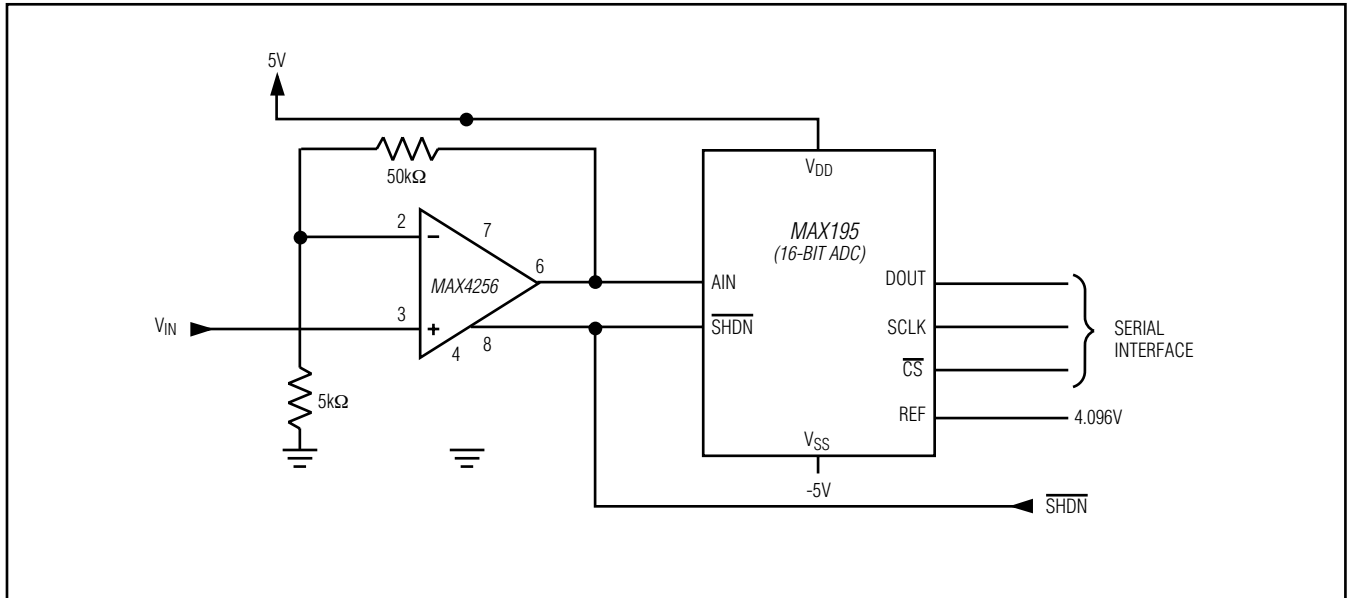

Selector Guide

| PART | GAIN BANDWIDTH (MHz) | MINIMUM STABLE GAIN (V/V) | NO. OF AMPLIFIERS PER PACKAGE | SHUTDOWN MODE | PIN-PACKAGE |
|-----------|----------------------|---------------------------|-------------------------------|---------------|---|
| MAX4249 | 22 | 10 | 2 | Yes | 10-pin μ MAX, 14-pin SO |
| MAX4250/A | 3 | 1 | 1 | — | 5-pin SOT23 |
| MAX4251 | 3 | 1 | 1 | Yes | 8-pin μ MAX/SO |
| MAX4252 | 3 | 1 | 2 | — | 8-pin μ MAX/SO, 8-bump UCSP |
| MAX4253 | 3 | 1 | 2 | Yes | 10-pin μ MAX, 14-pin SO, 10-bump UCSP |
| MAX4254 | 3 | 1 | 4 | — | 14-pin SO |
| MAX4255 | 22 | 10 | 1 | — | 5-pin SOT23 |
| MAX4256 | 22 | 10 | 1 | Yes | 8-pin μ MAX/SO |
| MAX4257 | 22 | 10 | 2 | — | 8-pin μ MAX/SO |

MAX4249-MAX4257

UCSP, Single-Supply, Low-Noise, Low-Distortion, Rail-to-Rail Op Amps

Pin/Bump Configurations (continued)

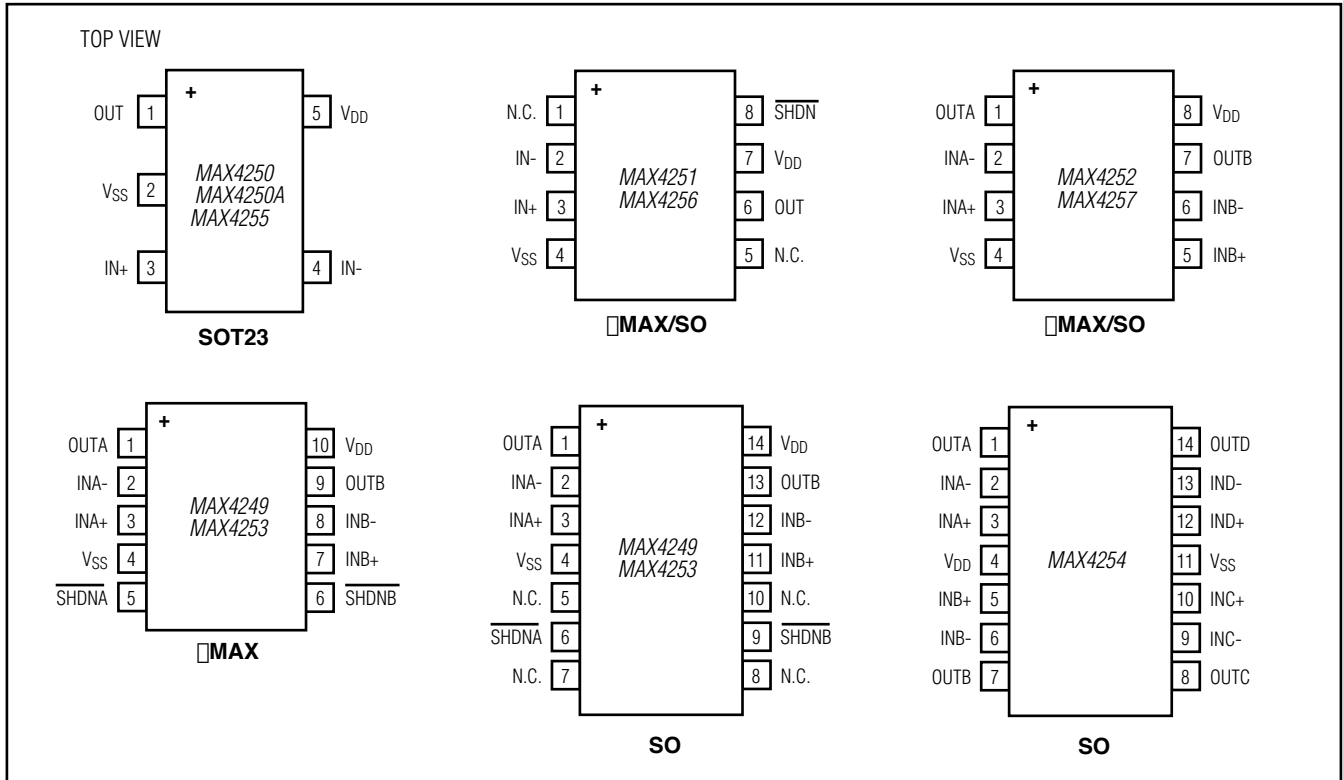

Ordering Information (continued)

| PART | TEMP RANGE | PIN-PACKAGE | TOP MARK |
|----------------|----------------|-------------|----------|
| MAX4251ESA+ | -40°C to +85°C | 8 SO | — |
| MAX4251EUA+ | -40°C to +85°C | 8 μMAX | — |
| MAX4252EBL+T | -40°C to +85°C | 8 UCSP | AAO |
| MAX4252ESA+ | -40°C to +85°C | 8 SO | — |
| MAX4252EUA+ | -40°C to +85°C | 8 μMAX | — |
| MAX4253EBC+T | -40°C to +85°C | 10 UCSP | AAK |
| MAX4253EUB+ | -40°C to +85°C | 10 μMAX | — |
| MAX4253ESD+ | -40°C to +85°C | 14 SO | — |
| MAX4254ESD+ | -40°C to +85°C | 14 SO | — |
| MAX4255EUK+T | -40°C to +85°C | 5 SOT23 | ACCJ |
| MAX4256ESA+ | -40°C to +85°C | 8 SO | — |
| MAX4256EUA+ | -40°C to +85°C | 8 μMAX | — |
| MAX4257ESA+ | -40°C to +85°C | 8 SO | — |
| MAX4257ESA/V+T | -40°C to +85°C | 8 SO | — |
| MAX4257EUA+ | -40°C to +85°C | 8 μMAX | — |

MAX4249-MAX4257

UCSP, Single-Supply, Low-Noise, Low-Distortion, Rail-to-Rail Op Amps

Package Information

For the latest package outline information and land patterns (footprints), go to www.maximintegrated.com/packages. Note that a "+", "#", or "-" in the package code indicates RoHS status only. Package drawings may show a different suffix character, but the drawing pertains to the package regardless of RoHS status.

| PACKAGE TYPE | PACKAGE CODE | OUTLINE NO. | LAND PATTERN NO. |
|---------------------|---------------------|-------------------------|-------------------------|
| 5 SOT-23 | U5+2 | 21-0057 | 90-0174 |
| 8 μ MAX | U8+1 | 21-0036 | 90-0092 |
| 10 μ MAX | U10+2 | 21-0061 | 90-0330 |
| 3 x 3 μ CSP | B9+5 | 21-0093 | — |
| 14 SOIC | S14+1 | 21-0041 | 90-0112 |
| 12 μ CSP | B12+4 | 21-0104 | — |

MAX4249-MAX4257

UCSP, Single-Supply, Low-Noise, Low-Distortion, Rail-to-Rail Op Amps

Revision History

| REVISION NUMBER | REVISION DATE | DESCRIPTION | PAGES CHANGED |
|-----------------|---------------|--|---------------|
| 8 | 10/11 | Added lead-free packaging to the <i>Ordering Information</i> and changed the Input Bias Current and Input Offset Current conditions in the <i>Electrical Characteristics</i> table | 1, 2, 14 |
| 9 | 12/12 | Added MAX4257ESA/V+T to <i>Ordering Information</i> . | 14 |



Maxim Integrated cannot assume responsibility for use of any circuitry other than circuitry entirely embodied in a Maxim Integrated product. No circuit patent licenses are implied. Maxim Integrated reserves the right to change the circuitry and specifications without notice at any time. The parametric values (min and max limits) shown in the Electrical Characteristics table are guaranteed. Other parametric values quoted in this data sheet are provided for guidance.