

## CDBF0540-HF

$I_o = 500 \text{ mA}$   
 $V_R = 40 \text{ Volts}$   
 RoHS Device  
 Halogen Free



### Features

- Low forward voltage.
- Designed for mounting on small surface.
- Extremely thin / leadless package.
- Majority carrier conduction.

### Mechanical data

- Case: 1005/SOD-323F standard package, molded plastic.
- Terminals: Gold plated, solderable per MIL-STD-750, method 2026.
- Marking code: cathode band & BN
- Mounting position: Any
- Weight: 0.006 gram(approx.).

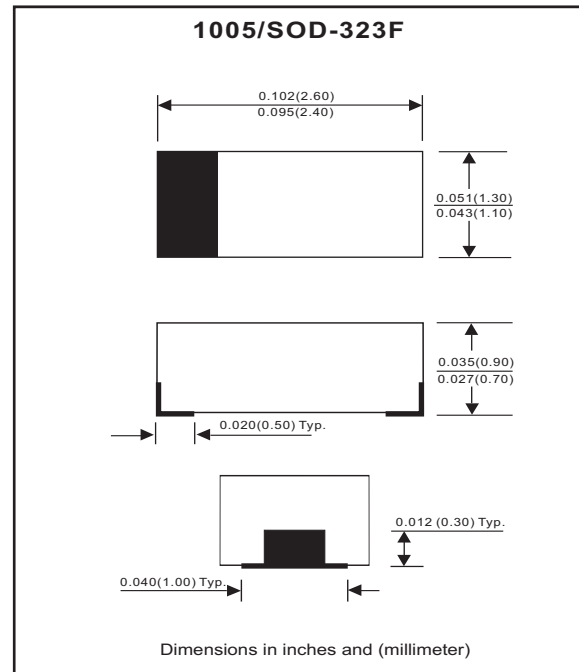

### Maximum Rating (at TA=25°C unless otherwise noted)

Parameter	Conditions	Symbol	Min	Typ	Max	Unit
Peak reverse voltage		$V_{RM}$			40	V
Reverse voltage		$V_R$			40	V
Average forward rectified current		$I_o$			500	mA
Forward current, surge peak	8.3 ms single half sine-wave superimposed on rate load (JEDEC method)	$I_{FSM}$			5.5	A
Storage temperature		$T_{STG}$	-40		+125	°C
Junction temperature		$T_j$			+125	°C

### Electrical Characteristics (at TA=25°C unless otherwise noted)

Parameter	Conditions	Symbol	Min	Typ	Max	Unit
Forward voltage	$I_F = 0.5 \text{ A @ } T_a = 25 \text{ }^\circ\text{C}$ $I_F = 1 \text{ A @ } T_a = 25 \text{ }^\circ\text{C}$ $I_F = 0.5 \text{ A @ } T_a = 100 \text{ }^\circ\text{C}$ $I_F = 1 \text{ A @ } T_a = 100 \text{ }^\circ\text{C}$	$V_F$			0.51 0.64 0.46 0.62	V
Reverse current	$V_R = 20 \text{ V @ } T_a = 25 \text{ }^\circ\text{C}$ $V_R = 40 \text{ V @ } T_a = 25 \text{ }^\circ\text{C}$ $V_R = 20 \text{ V @ } T_a = 100 \text{ }^\circ\text{C}$ $V_R = 40 \text{ V @ } T_a = 100 \text{ }^\circ\text{C}$	$I_R$			0.01 0.02 2 5	mA
Capacitance between terminals	f = 1 MHz, and 0 VDC reverse voltage	$C_T$			170	pF
Reverse recovery time	$I_F = I_R = 10 \text{ mA}$ , $I_{rr} \times I_R$ , $R_L = 100 \text{ ohm}$	$T_{rr}$		22		ns

## RATING AND CHARACTERISTIC CURVES (CDBF0540-HF)

Fig. 1 - Forward characteristics

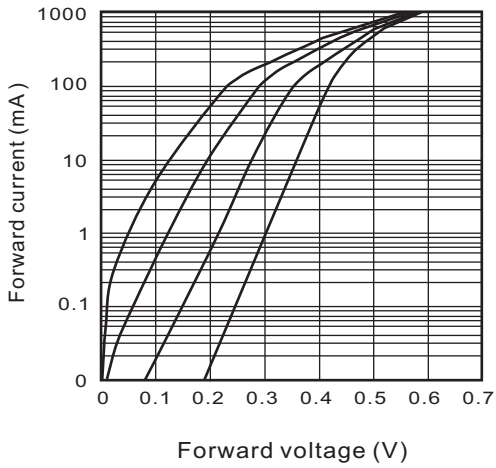

Fig. 2 - Reverse characteristics

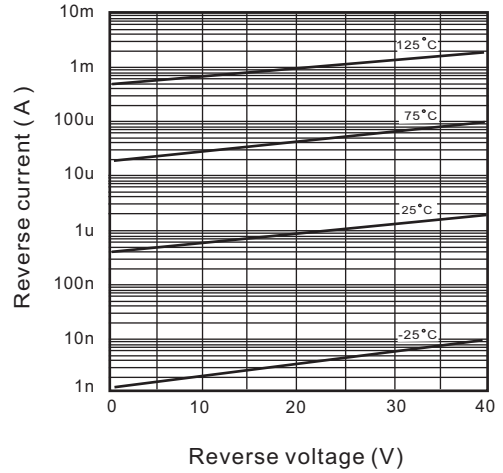

Fig. 3 - Capacitance between terminals characteristics

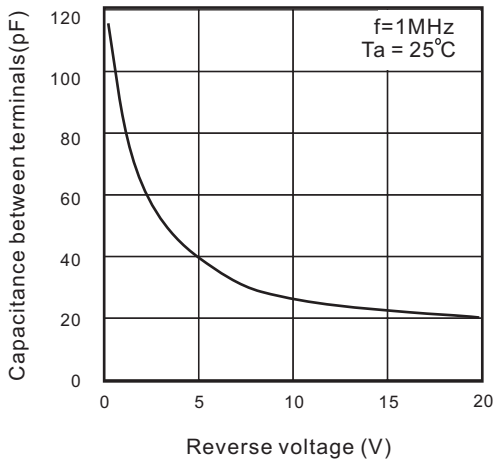
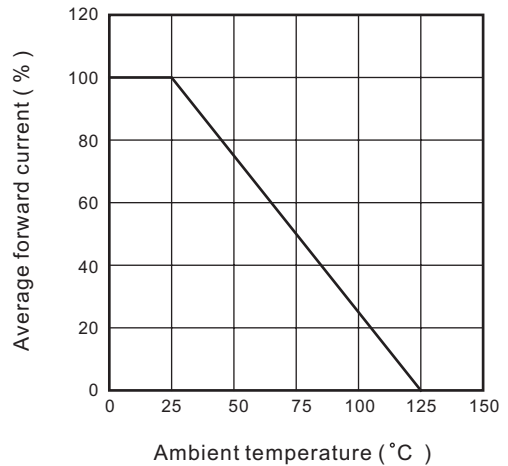
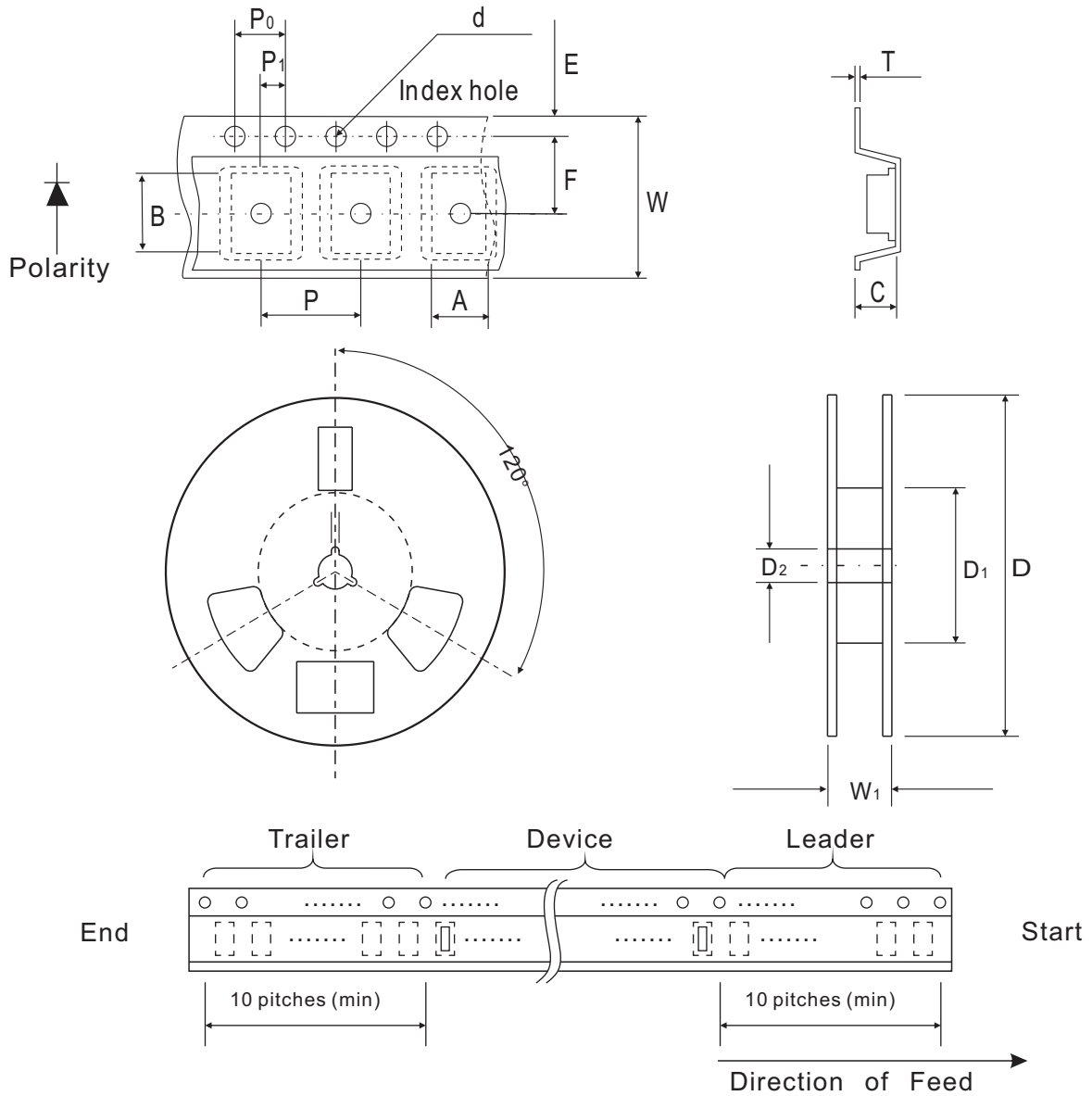

Fig. 4 - Current derating curve



## Reel Taping Specification



1005 (SOD-323F)	SYMBOL	A	B	C	d	D	D <sub>1</sub>	D <sub>2</sub>
	(mm)	1.55 ± 0.10	2.65 ± 0.10	1.05 ± 0.10	1.55 ± 0.05	178 ± 1	60.0 MIN.	13.0 ± 0.20
	(inch)	0.061 ± 0.004	0.104 ± 0.004	0.041 ± 0.004	0.061 ± 0.002	7.008 ± 0.04	2.362 MIN.	0.512 ± 0.008

1005 (SOD-323F)	SYMBOL	E	F	P	P <sub>0</sub>	P <sub>1</sub>	T	W	W <sub>1</sub>
	(mm)	1.75 ± 0.10	3.50 ± 0.05	4.00 ± 0.10	4.00 ± 0.10	2.00 ± 0.05	0.23 ± 0.05	8.00 ± 0.20	13.5 MAX.
	(inch)	0.069 ± 0.004	0.138 ± 0.002	0.157 ± 0.004	0.157 ± 0.004	0.079 ± 0.004	0.009 ± 0.002	0.315 ± 0.008	0.531 MAX.

## Marking Code

Park Number	Marking Code
CDBF0540-HF	BN



## Suggested PAD Layout

SIZE	1005/SOD-323F	
	(mm)	(inch)
A	2.10	0.083
B	1.20	0.047
C	1.20	0.047
D	3.30	0.130
E	0.90	0.035

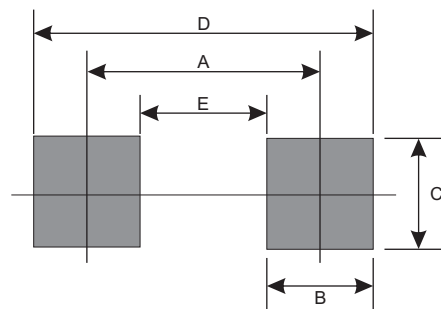

## Standard Package

Case Type	Qty per Reel	Reel Size
	(Pcs)	(inch)
1005/SOD-323F	4000	7