

# RF Power Field Effect Transistors

## N-Channel Enhancement-Mode Lateral MOSFETs

Designed for GSM and GSM EDGE base station applications with frequencies from 1800 to 2000 MHz. Suitable for TDMA, CDMA and multicarrier amplifier applications. To be used in Class AB for PCN-PCS/cellular radio and WLL applications. Specified for GSM-GSM EDGE 1805-1880 MHz.

- GSM and GSM EDGE Performance, Full Frequency Band (1805-1880 MHz)  
Power Gain - 15 dB (Typ) @ 85 Watts CW  
Efficiency - 52% (Typ) @ 85 Watts CW
- Capable of Handling 5:1 VSWR, @ 26 Vdc, 1840 MHz, 85 Watts CW Output Power

### Features

- Internally Matched for Ease of Use
- High Gain, High Efficiency and High Linearity
- Integrated ESD Protection
- Designed for Maximum Gain and Insertion Phase Flatness
- Excellent Thermal Stability
- Characterized with Series Equivalent Large-Signal Impedance Parameters
- Available with Low Gold Plating Thickness on Leads. L Suffix Indicates 40μ" Nominal.
- RoHS Compliant
- In Tape and Reel. R3 Suffix = 250 Units per 56 mm, 13 inch Reel.

**MRF18085ALR3**  
**MRF18085ALSR3**

**1805-1880 MHz, 85 W, 26 V**  
**GSM/GSM EDGE**  
**LATERAL N-CHANNEL**  
**RF POWER MOSFETs**

**CASE 465-06, STYLE 1**  
**NI-780**  
**MRF18085ALR3**

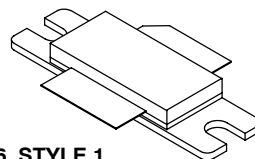

**CASE 465A-06, STYLE 1**  
**NI-780S**  
**MRF18085ALSR3**

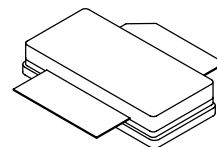

ARCHIVE INFORMATION

ARCHIVE INFORMATION

**Table 1. Maximum Ratings**

Rating	Symbol	Value	Unit
Drain-Source Voltage	V <sub>DSS</sub>	-0.5, +65	Vdc
Gate-Source Voltage	V <sub>GS</sub>	-0.5, +15	Vdc
Total Device Dissipation @ T <sub>C</sub> = 25°C Derate above 25°C	P <sub>D</sub>	273 1.56	W W/°C
Storage Temperature Range	T <sub>stg</sub>	- 65 to +150	°C
Case Operating Temperature	T <sub>C</sub>	150	°C
Operating Junction Temperature	T <sub>J</sub>	200	°C

**Table 2. Thermal Characteristics**

Characteristic	Symbol	Value (1)	Unit
Thermal Resistance, Junction to Case	R <sub>θJC</sub>	0.79	°C/W

**Table 3. ESD Protection Characteristics**

Test Conditions	Class
Human Body Model	1 (Minimum)
Machine Model	M3 (Minimum)

1. Refer to AN1955/D, *Thermal Measurement Methodology of RF Power Amplifiers*. Go to <http://www.freescale.com/rf>.  
Select Documentation/Application Notes - AN1955.

**Table 4. Electrical Characteristics** ( $T_C = 25^\circ\text{C}$  unless otherwise noted)

Characteristic	Symbol	Min	Typ	Max	Unit
<b>Off Characteristics</b>					
Drain-Source Breakdown Voltage ( $V_{GS} = 0\text{ Vdc}$ , $I_D = 100\ \mu\text{Adc}$ )	$V_{(BR)DSS}$	65	—	—	Vdc
Zero Gate Voltage Drain Current ( $V_{DS} = 26\text{ Vdc}$ , $V_{GS} = 0\text{ Vdc}$ )	$I_{DSS}$	—	—	10	$\mu\text{Adc}$
Gate-Source Leakage Current ( $V_{GS} = 5\text{ Vdc}$ , $V_{DS} = 0\text{ Vdc}$ )	$I_{GSS}$	—	—	1	$\mu\text{Adc}$
<b>On Characteristics</b>					
Gate Threshold Voltage ( $V_{DS} = 10\text{ Vdc}$ , $I_D = 200\ \mu\text{Adc}$ )	$V_{GS(th)}$	2	—	4	Vdc
Gate Quiescent Voltage ( $V_{DS} = 26\text{ Vdc}$ , $I_D = 600\ \text{mAdc}$ )	$V_{GS(Q)}$	2.5	3.9	4.5	Vdc
Drain-Source On-Voltage ( $V_{GS} = 10\text{ Vdc}$ , $I_D = 2\text{ Adc}$ )	$V_{DS(on)}$	—	0.15	—	Vdc
<b>Dynamic Characteristics</b>					
Reverse Transfer Capacitance (1) ( $V_{DS} = 26\text{ Vdc}$ , $V_{GS} = 0$ , $f = 1\text{ MHz}$ )	$C_{rss}$	—	3.6	—	pF
<b>Functional Tests</b> (In Freescale Test Fixture, 50 ohm system)					
Common-Source Amplifier Power Gain @ 85 W (2) ( $V_{DD} = 26\text{ Vdc}$ , $I_{DQ} = 800\text{ mA}$ , $f = 1805 - 1880\text{ MHz}$ )	$G_{ps}$	13.5	15	—	dB
Drain Efficiency @ 85 W (2) ( $V_{DD} = 26\text{ Vdc}$ , $I_{DQ} = 800\text{ mA}$ , $f = 1805 - 1880\text{ MHz}$ )	$\eta$	48	52	—	%
Input Return Loss @ 85 W (2) ( $V_{DD} = 26\text{ Vdc}$ , $I_{DQ} = 800\text{ mA}$ , $f = 1805 - 1880\text{ MHz}$ )	IRL	—	-12	-9	dB
Power Output, 1 dB Compression Point ( $V_{DD} = 26\text{ Vdc}$ , $I_{DQ} = 800\text{ mA}$ , $f = 1805 - 1880\text{ MHz}$ )	P1dB	83	90	—	Watts

1. Part is internally matched both on input and output.
2. To meet application requirements, Freescale test fixtures have been designed to cover the full GSM1800 band, ensuring batch-to-batch consistency.

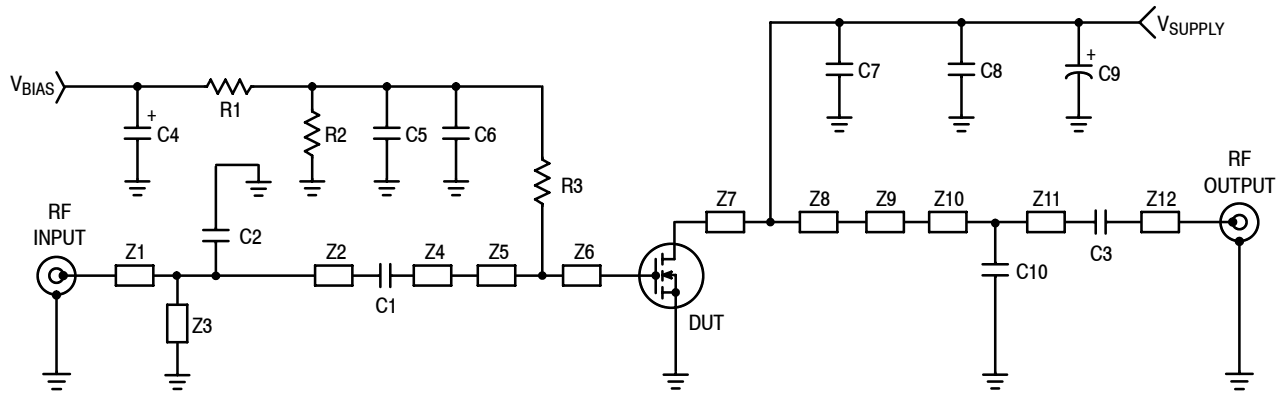

C1, C3, C6, C7	10 pF Chip Capacitors, ATC	Z4	0.610" x 0.118" Microstrip
C2	1.8 pF Chip Capacitor, ATC	Z5	0.331" x 1.153" Microstrip
C4	10 $\mu$ F, 35 V Tantalum Capacitor, AVX	Z6	0.063" x 1.153" Microstrip
C5, C8	1 nF Chip Capacitors, ATC	Z7	0.122" x 0.925" Microstrip
C9	220 $\mu$ F, 63 V Electrolytic Capacitor, Radial, Philips	Z8	0.547" x 0.925" Microstrip
C10	0.3 pF Chip Capacitor, ATC	Z9	0.394" x 0.177" Microstrip
R1, R2	10 k $\Omega$ , 1/4 W Chip Resistors (1206)	Z10	0.180" x 0.087" Microstrip
R3	1.0 k $\Omega$ , 1/4 W Chip Resistor (1206)	Z11	0.686" x 0.087" Microstrip
Z1	0.671" x 0.087" Microstrip	Z12	0.294" x 0.087" Microstrip
Z2	0.568" x 0.087" Microstrip	PCB	Taconic TLX8, 30 mils, $\epsilon_r = 2.55$
Z3	0.500" x 0.098" Microstrip Shorted Stub		

Figure 1. 1805-1880 MHz Test Fixture Schematic

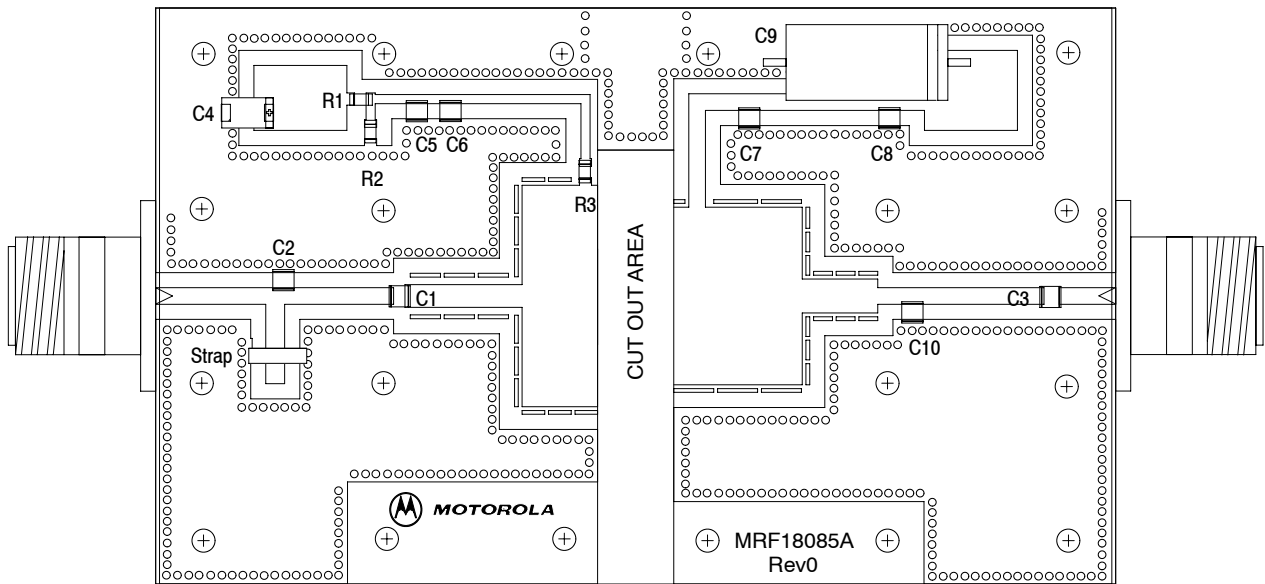

Freescale has begun the transition of marking Printed Circuit Boards (PCBs) with the Freescale Semiconductor signature/logo. PCBs may have either Motorola or Freescale markings during the transition period. These changes will have no impact on form, fit or function of the current product.

Figure 2. 1805-1880 MHz Test Fixture Component Layout

### TYPICAL CHARACTERISTICS

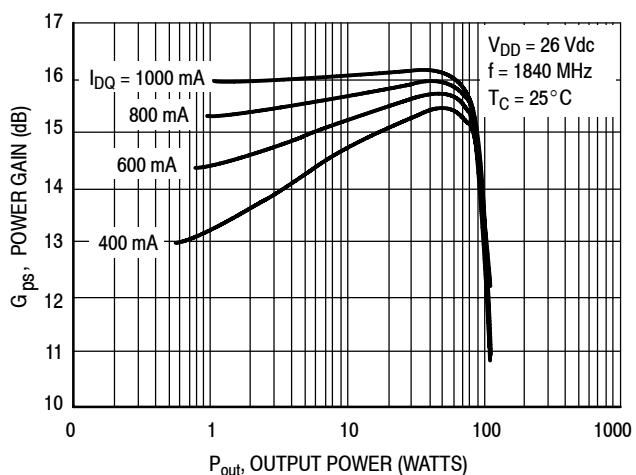

Figure 3. Power Gain versus Output Power

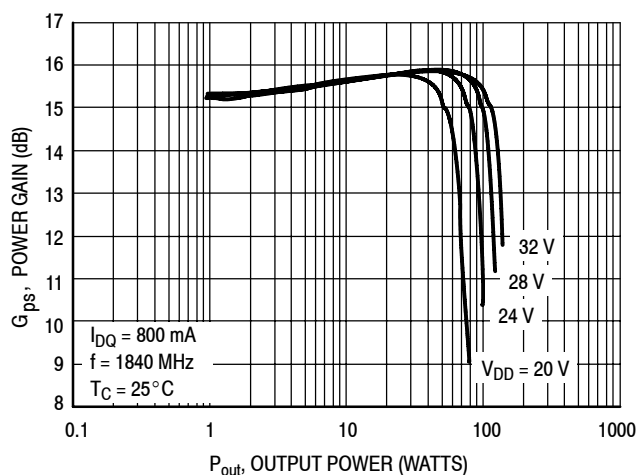

Figure 4. Power Gain versus Output Power

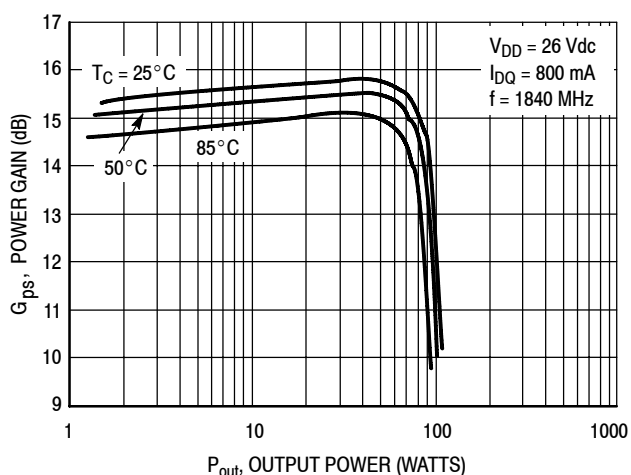

Figure 5. Power Gain versus Output Power

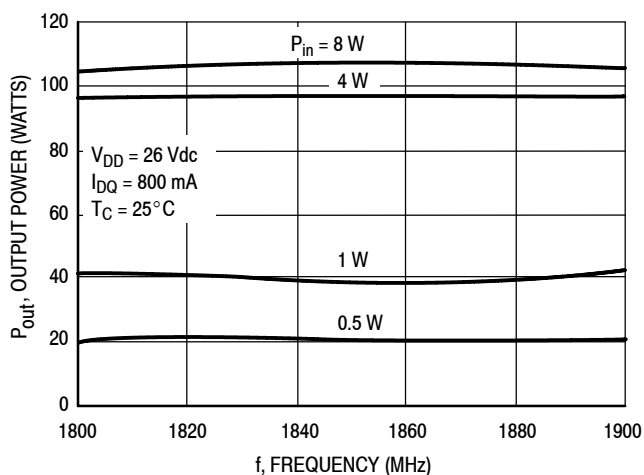

Figure 6. Output Power versus Frequency

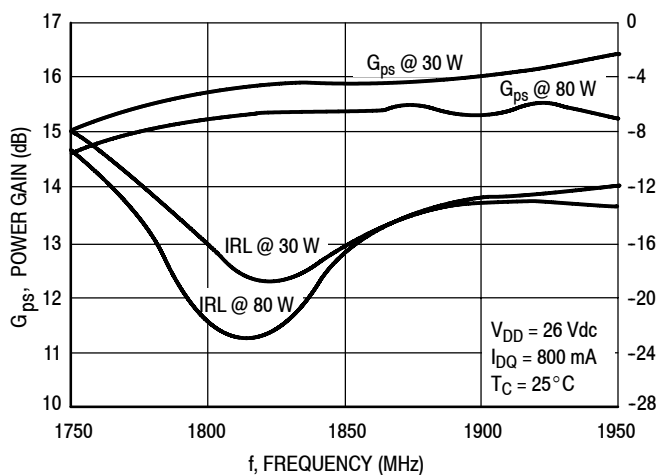

Figure 7. Power Gain versus Frequency

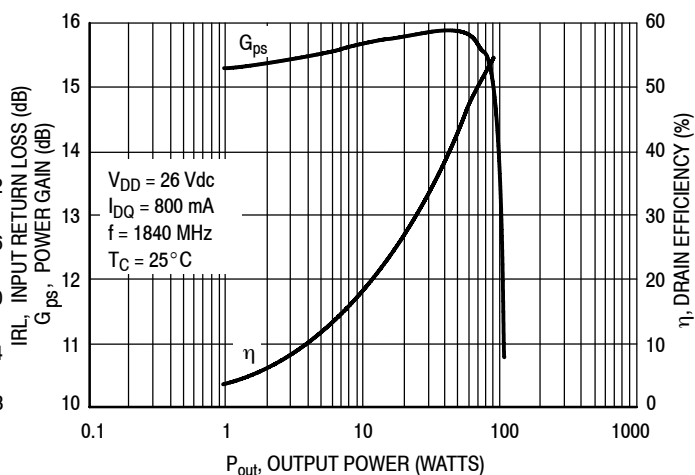
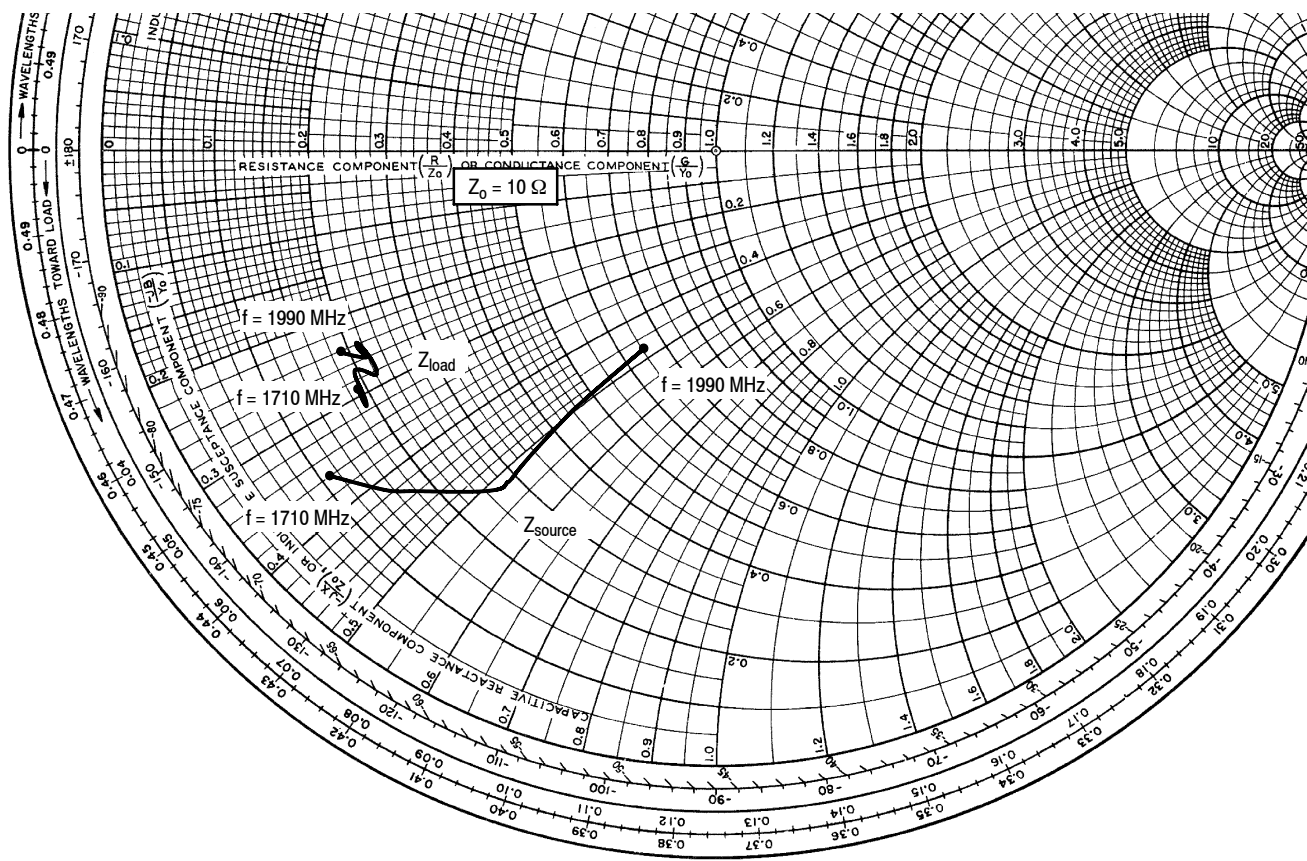

Figure 8. Power Gain and Efficiency versus Output Power

ARCHIVE INFORMATION

ARCHIVE INFORMATION



$V_{DD} = 26\text{ V}$ ,  $I_{DQ} = 800\text{ mA}$ ,  $P_{out} = 85\text{ W CW}$

f MHz	$Z_{source}$ $\Omega$	$Z_{load}$ $\Omega$
1710	$1.13 - j3.62$	$1.79 - j2.88$
1785	$1.61 - j4.23$	$1.82 - j3.15$
1805	$1.69 - j4.34$	$1.90 - j2.66$
1880	$2.83 - j5.25$	$2.09 - j2.77$
1930	$3.00 - j5.18$	$2.01 - j2.44$
1960	$4.39 - j4.97$	$2.01 - j2.57$
1990	$6.59 - j4.74$	$1.79 - j2.37$

$Z_{source}$  = Test circuit impedance as measured from gate to ground.

$Z_{load}$  = Test circuit impedance as measured from drain to ground.

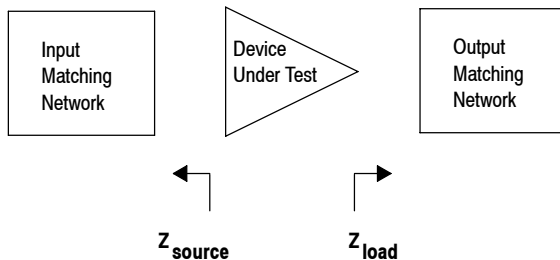
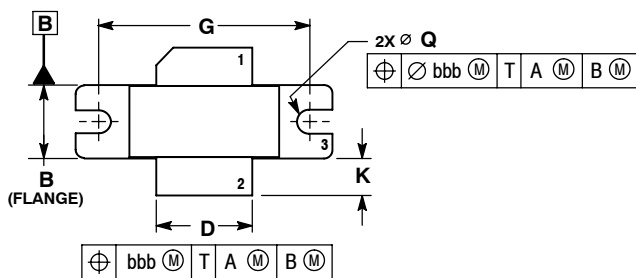

Figure 9. Series Equivalent Source and Load Impedance

ARCHIVE INFORMATION

ARCHIVE INFORMATION

### PACKAGE DIMENSIONS



- NOTES:
1. DIMENSIONING AND TOLERANCING PER ANSI Y14.5M-1994.
  2. CONTROLLING DIMENSION: INCH.
  3. DELETED
  4. DIMENSION H IS MEASURED 0.030 (0.762) AWAY FROM PACKAGE BODY.

DIM	INCHES		MILLIMETERS	
	MIN	MAX	MIN	MAX
A	1.335	1.345	33.91	34.16
B	0.380	0.390	9.65	9.91
C	0.125	0.170	3.18	4.32
D	0.495	0.505	12.57	12.83
E	0.035	0.045	0.89	1.14
F	0.003	0.006	0.08	0.15
G	1.100 BSC		27.94 BSC	
H	0.057	0.067	1.45	1.70
K	0.170	0.210	4.32	5.33
M	0.774	0.786	19.66	19.96
N	0.772	0.788	19.60	20.00
Q	Ø.118	Ø.138	Ø.300	Ø.351
R	0.365	0.375	9.27	9.53
S	0.365	0.375	9.27	9.52
aaa	0.005 REF		0.127 REF	
bbb	0.010 REF		0.254 REF	
ccc	0.015 REF		0.381 REF	

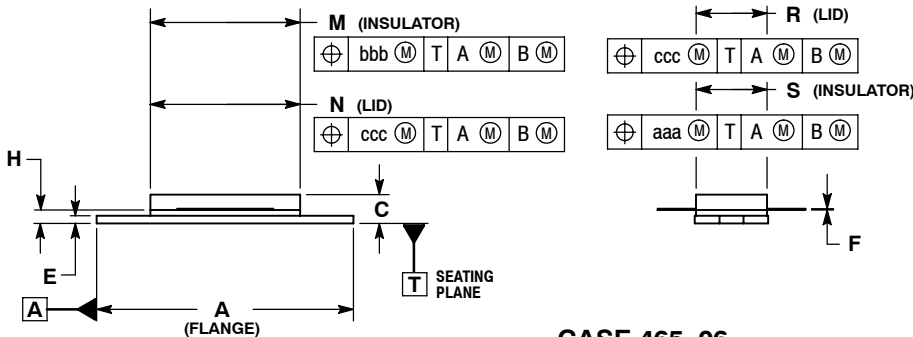

**CASE 465-06  
ISSUE G  
NI-780  
MRF18085ALR3**

- STYLE 1:  
PIN 1. DRAIN  
2. GATE  
3. SOURCE

ARCHIVE INFORMATION

ARCHIVE INFORMATION

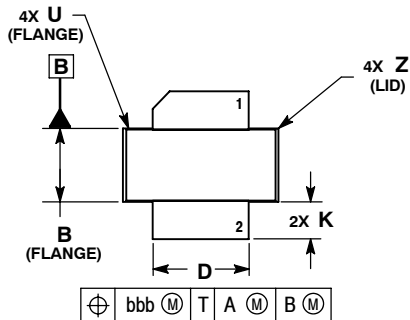

- NOTES:
1. DIMENSIONING AND TOLERANCING PER ANSI Y14.5M-1994.
  2. CONTROLLING DIMENSION: INCH.
  3. DELETED
  4. DIMENSION H IS MEASURED 0.030 (0.762) AWAY FROM PACKAGE BODY.

DIM	INCHES		MILLIMETERS	
	MIN	MAX	MIN	MAX
A	0.805	0.815	20.45	20.70
B	0.380	0.390	9.65	9.91
C	0.125	0.170	3.18	4.32
D	0.495	0.505	12.57	12.83
E	0.035	0.045	0.89	1.14
F	0.003	0.006	0.08	0.15
H	0.057	0.067	1.45	1.70
K	0.170	0.210	4.32	5.33
M	0.774	0.786	19.61	20.02
N	0.772	0.788	19.61	20.02
R	0.365	0.375	9.27	9.53
S	0.365	0.375	9.27	9.52
U	---	0.040	---	1.02
Z	---	0.030	---	0.76
aaa	0.005 REF		0.127 REF	
bbb	0.010 REF		0.254 REF	
ccc	0.015 REF		0.381 REF	

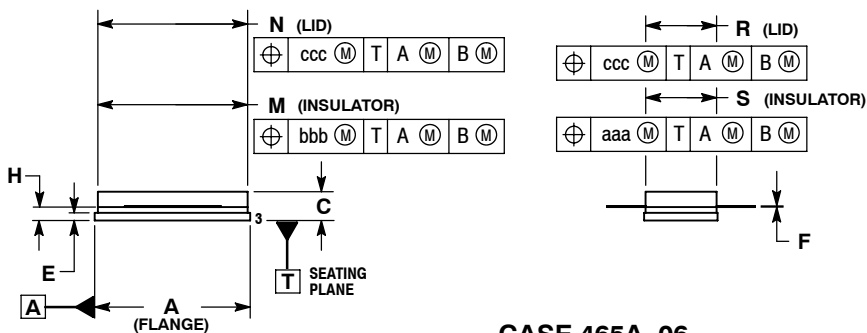

**CASE 465A-06  
ISSUE H  
NI-780S  
MRF18085ALSR3**

- STYLE 1:  
PIN 1. DRAIN  
2. GATE  
5. SOURCE

## REVISION HISTORY

The following table summarizes revisions to this document.

Revision	Date	Description
6	Dec. 2010	<ul style="list-style-type: none"> <li>• MRF18085A Rev. 6 data sheet archived. Data sheet split due to change in part life cycle. See MRF18085A-1 Rev. 7 for MRF18085ALR3 and MRF18085A-2 Rev. 8 for MRF18085ALSR3.</li> </ul>

ARCHIVE INFORMATION

ARCHIVE INFORMATION



**How to Reach Us:**

**Home Page:**  
www.freescale.com

**E-mail:**  
support@freescale.com

**USA/Europe or Locations Not Listed:**  
Freescale Semiconductor  
Technical Information Center, CH370  
1300 N. Alma School Road  
Chandler, Arizona 85224  
+1-800-521-6274 or +1-480-768-2130  
support@freescale.com

**Europe, Middle East, and Africa:**  
Freescale Halbleiter Deutschland GmbH  
Technical Information Center  
Schatzbogen 7  
81829 Muenchen, Germany  
+44 1296 380 456 (English)  
+46 8 52200080 (English)  
+49 89 92103 559 (German)  
+33 1 69 35 48 48 (French)  
support@freescale.com

**Japan:**  
Freescale Semiconductor Japan Ltd.  
Headquarters  
ARCO Tower 15F  
1-8-1, Shimo-Meguro, Meguro-ku,  
Tokyo 153-0064  
Japan  
0120 191014 or +81 3 5437 9125  
support.japan@freescale.com

**Asia/Pacific:**  
Freescale Semiconductor Hong Kong Ltd.  
Technical Information Center  
2 Dai King Street  
Tai Po Industrial Estate  
Tai Po, N.T., Hong Kong  
+800 2666 8080  
support.asia@freescale.com

**For Literature Requests Only:**  
Freescale Semiconductor Literature Distribution Center  
P.O. Box 5405  
Denver, Colorado 80217  
1-800-441-2447 or 303-675-2140  
Fax: 303-675-2150  
LDCForFreescaleSemiconductor@hibbertgroup.com

Information in this document is provided solely to enable system and software implementers to use Freescale Semiconductor products. There are no express or implied copyright licenses granted hereunder to design or fabricate any integrated circuits or integrated circuits based on the information in this document.

Freescale Semiconductor reserves the right to make changes without further notice to any products herein. Freescale Semiconductor makes no warranty, representation or guarantee regarding the suitability of its products for any particular purpose, nor does Freescale Semiconductor assume any liability arising out of the application or use of any product or circuit, and specifically disclaims any and all liability, including without limitation consequential or incidental damages. "Typical" parameters that may be provided in Freescale Semiconductor data sheets and/or specifications can and do vary in different applications and actual performance may vary over time. All operating parameters, including "Typicals", must be validated for each customer application by customer's technical experts. Freescale Semiconductor does not convey any license under its patent rights nor the rights of others. Freescale Semiconductor products are not designed, intended, or authorized for use as components in systems intended for surgical implant into the body, or other applications intended to support or sustain life, or for any other application in which the failure of the Freescale Semiconductor product could create a situation where personal injury or death may occur. Should Buyer purchase or use Freescale Semiconductor products for any such unintended or unauthorized application, Buyer shall indemnify and hold Freescale Semiconductor and its officers, employees, subsidiaries, affiliates, and distributors harmless against all claims, costs, damages, and expenses, and reasonable attorney fees arising out of, directly or indirectly, any claim of personal injury or death associated with such unintended or unauthorized use, even if such claim alleges that Freescale Semiconductor was negligent regarding the design or manufacture of the part.

Freescale™ and the Freescale logo are trademarks of Freescale Semiconductor, Inc. All other product or service names are the property of their respective owners.  
© Freescale Semiconductor, Inc. 2006, 2010. All rights reserved.