

Features

- Single Stage, Single Ended
- 3 to 5 V Operation
- Low Current, 50 mA
- 20 dB Flat Gain
- 1.2 dB NF Noise
- Low Distortion Performance
- Lead-Free SOT-89 Plastic Package
- Halogen-Free “Green” Mold Compound
- RoHS* Compliant

Description

The MAAL-011136 is an RF amplifier assembled in a SOT-89 plastic package. This amplifier provides 20 dB of flat gain while biased from 3 to 5 volts. The amplifier provides excellent noise figure.

The MAAL-011136 provides high gain, low noise and low distortion making it ideally suited as input stage for fiber-to-the-home (FTTH) applications and other 75 Ω infrastructure applications.

The MAAL-011136 is fabricated using GaAs pHEMT technology.

Ordering Information^{1,2}

Part Number	Package
MAAL-011136-TR1000	1000 Part Reel
MAAL-011136-TR3000	3000 Part Reel
MAAL-011136-001SMB	Sample Board

1. Reference Application Note M513 for reel size information.
2. All sample boards include 5 loose parts.

Functional Schematic

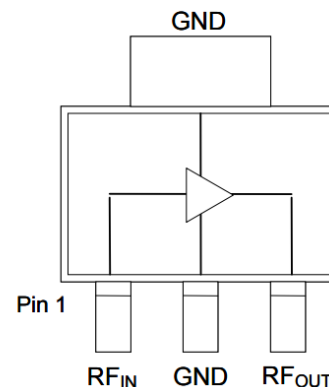

Pin Configuration

Pin No.	Pin Name	Function
1	RF _{IN}	RF Input
2	GND	Ground
3	RF _{OUT}	RF Output /Drain Supply

* Restrictions on Hazardous Substances, European Union Directive 2011/65/EU.

75 Ω CATV, FTTx Low Noise Amplifier 45 - 1218 MHz

Rev. V1

Electrical Specifications: $T_A = 25^\circ\text{C}$, $V_{DD} = 5\text{ V}$, $Z_0 = 75\ \Omega$

Parameter	Test Conditions	Units	Min.	Typ.	Max.
Gain	45 - 1218 MHz	dB	19	20.5	22
Gain Flatness	45 - 1218 MHz	dB	—	+/- 0.2	—
Reverse Isolation	45 - 1218 MHz	dB	—	25	—
Input Return Loss	45 - 1218 MHz	dB	—	10	—
Output Return Loss	45 - 1218 MHz	dB	—	16	—
Noise Figure	45 - 1218 MHz 1218 MHz	dB	— —	1.2 1.2	— 1.6
Output IP2	45 - 1200 MHz, tone spacing 6 MHz, P_{OUT} per tone = 4 dBm	dBm	—	43	—
Output IP3	45 - 1200 MHz, tone spacing 6 MHz, P_{OUT} per tone = 4 dBm	dBm	—	32	—
P1dB	45 - 1218 MHz	dBm	—	17.5	—
Composite Triple Beat, CTB	79 channels, 0 dB Tilt, 18 dBmV per channel output, QAM to 1000 MHz	dBc	—	-79	—
Composite Second Order, CSO	79 channels, 0 dB Tilt, 18 dBmV per channel output, QAM to 1000 MHz	dBc	—	-62	—
I_{DD}	$V_{DD} = 5\text{ V}$	mA	—	53	62

Absolute Maximum Ratings^{3,4,5,6}

Parameter	Absolute Maximum
Input Power	10 dBm
Operating Voltage	6 volts
Operating Temperature	-40°C to +85°C
Storage Temperature	-65°C to +150°C

- Exceeding any one or combination of these limits may cause permanent damage to this device.
- MACOM does not recommend sustained operation near these survivability limits.
- These operating conditions will ensure MTTF > 1×10^6 hours.
- Junction Temperature (T_J) = Case Temperature (T_C) + $\Theta_{jc} \cdot (V \cdot I)$
Typical thermal resistance (Θ_{jc}) = 67°C/W.
 - For $T_C = 25^\circ\text{C}$,
 $T_J = 42^\circ\text{C} @ 5\text{ V}, 53\text{ mA}$
 - For $T_C = 85^\circ\text{C}$,
 $T_J = 103^\circ\text{C} @ 5\text{ V}, 53\text{ mA}$

Handling Procedures

Please observe the following precautions to avoid damage:

Static Sensitivity

Integrated Circuits are sensitive to electrostatic discharge (ESD) and can be damaged by static electricity. Proper ESD control techniques should be used when handling these HBM Class 1A.

Schematic Including Off-Chip Components

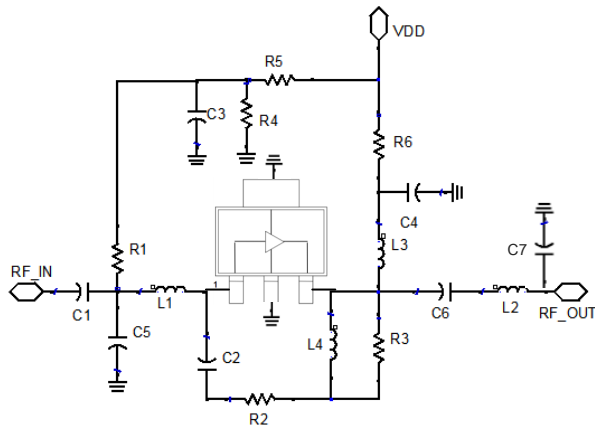

Parts List, $V_{DD} = 5\text{ V}$

Component	Value	Package
C1-C4	10 nF	0402
C5	1.5 pF	0402
C6	1000 pF	0402
C7	1.0 pF	0402
L1	6.2 nH	0402
L2	6.8 nH	0402
L3	Ferrite Bead ⁷	0402
L4	68 nH ⁸	0402
R1	8.06 kΩ	0402
R2	931 Ω	0402
R3	464 Ω	0402
R4	1.54 kΩ	0402
R5	8.06 kΩ	0402
R6	19.1 Ω	0402

7. Murata, part number BLM15HD182SN.

8. Coilcraft, part number 0402CS-68NXJLW

Recommended PCB Layout

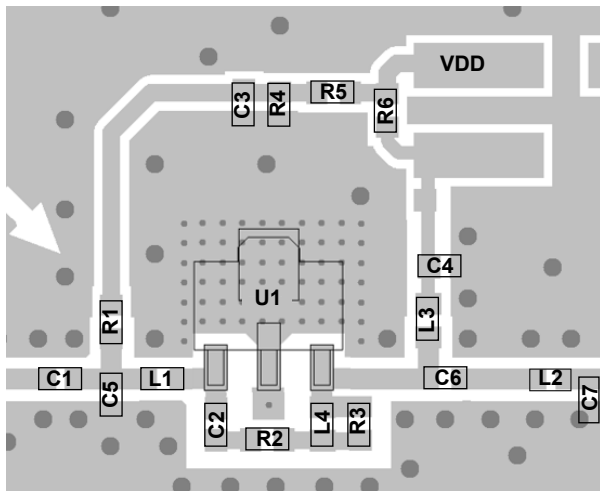

Recommended PCB Land Pattern

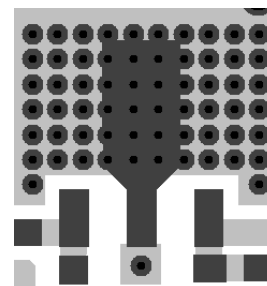

60 vias beneath package

0.012 in. via diameter

Typical Performance Curves: $V_{DD} = 5\text{ V}$

Gain to 1.218 GHz

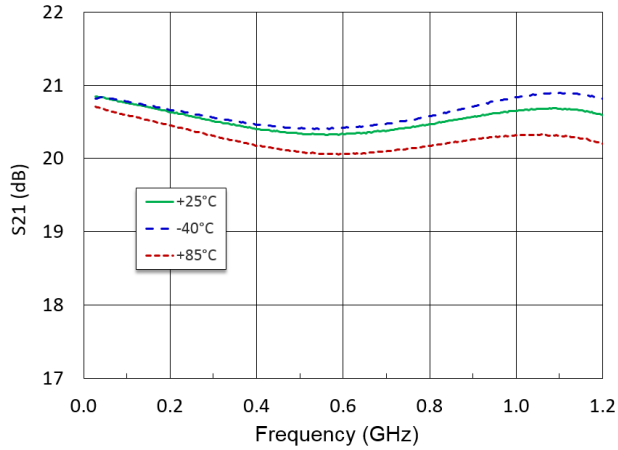

Noise Figure to 1.218 GHz

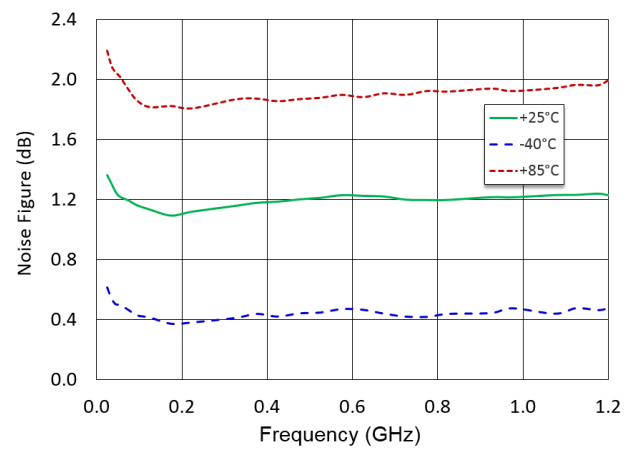

Gain to 3 GHz

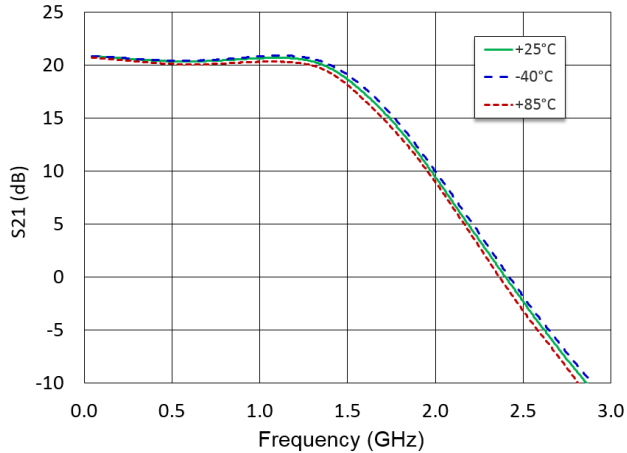

Output Return Loss to 1.218 GHz

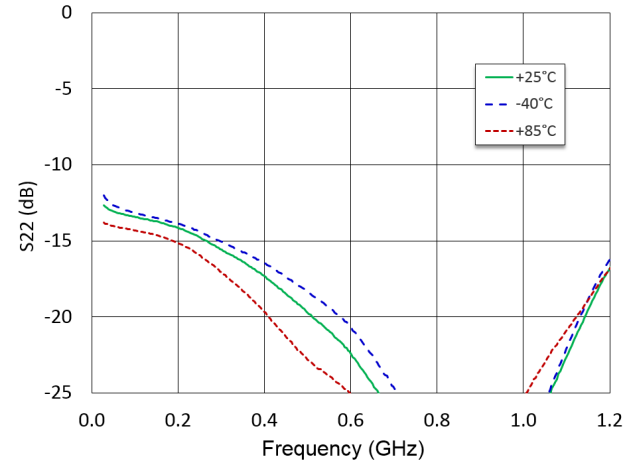

Reverse Isolation to 3 GHz

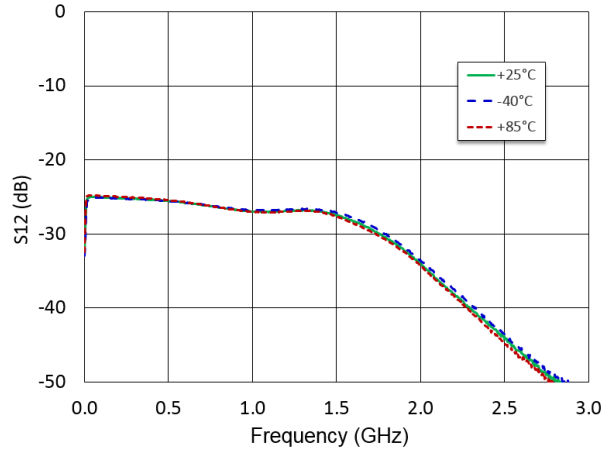

Input Return Loss to 1.218 GHz

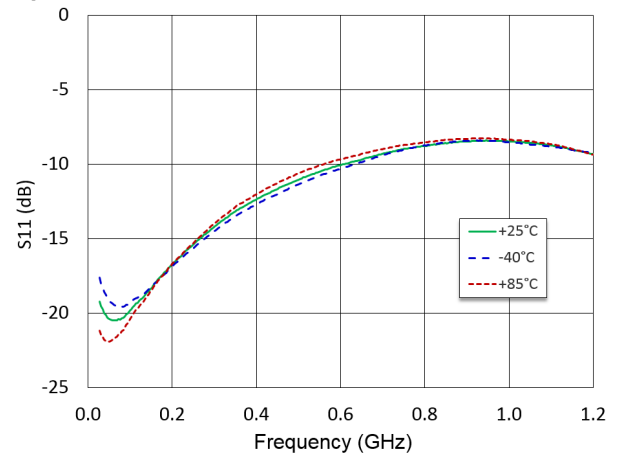

Typical Performance Curves: $V_{DD} = 5\text{ V}$

CTB

79 analog channels + QAM, 0 dB tilt,
 $P_{OUT} = 18\text{ dBmV}$ per channel

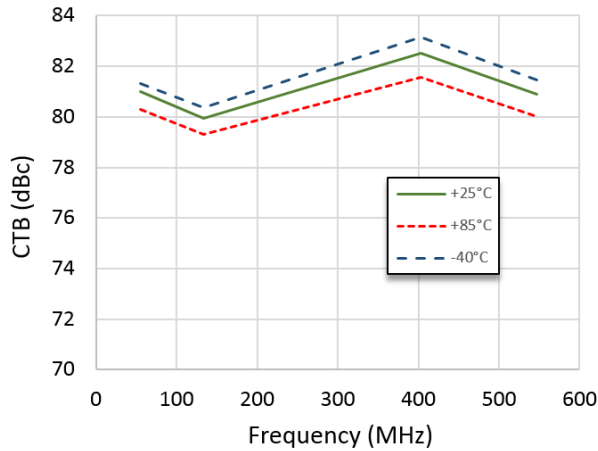

CSO Lower

79 analog channels + QAM, 0 dB tilt,
 $P_{OUT} = 18\text{ dBmV}$ per channel

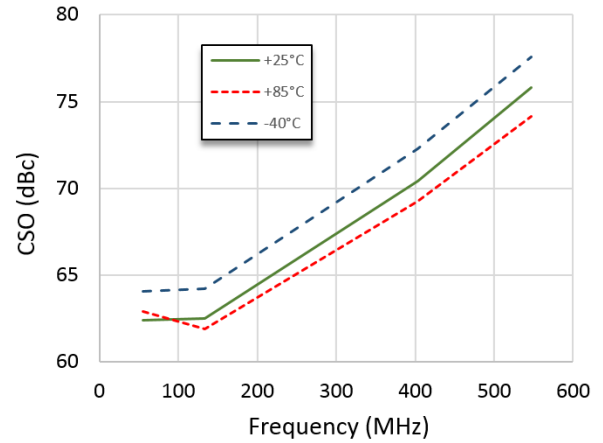

CSO Upper

79 analog channels + QAM, 0 dB tilt,
 $P_{OUT} = 18\text{ dBmV}$ per channel

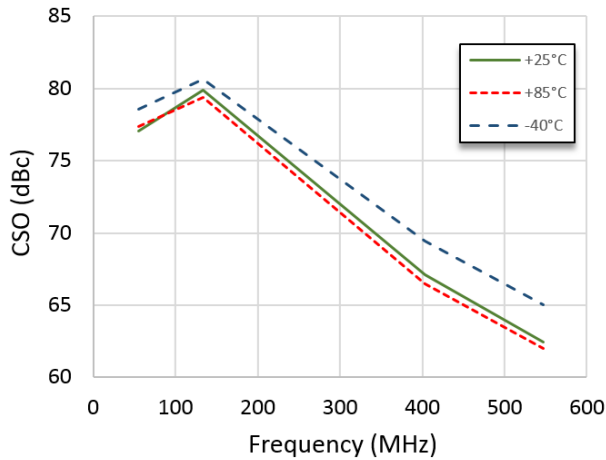

Lead Free SOT-89†

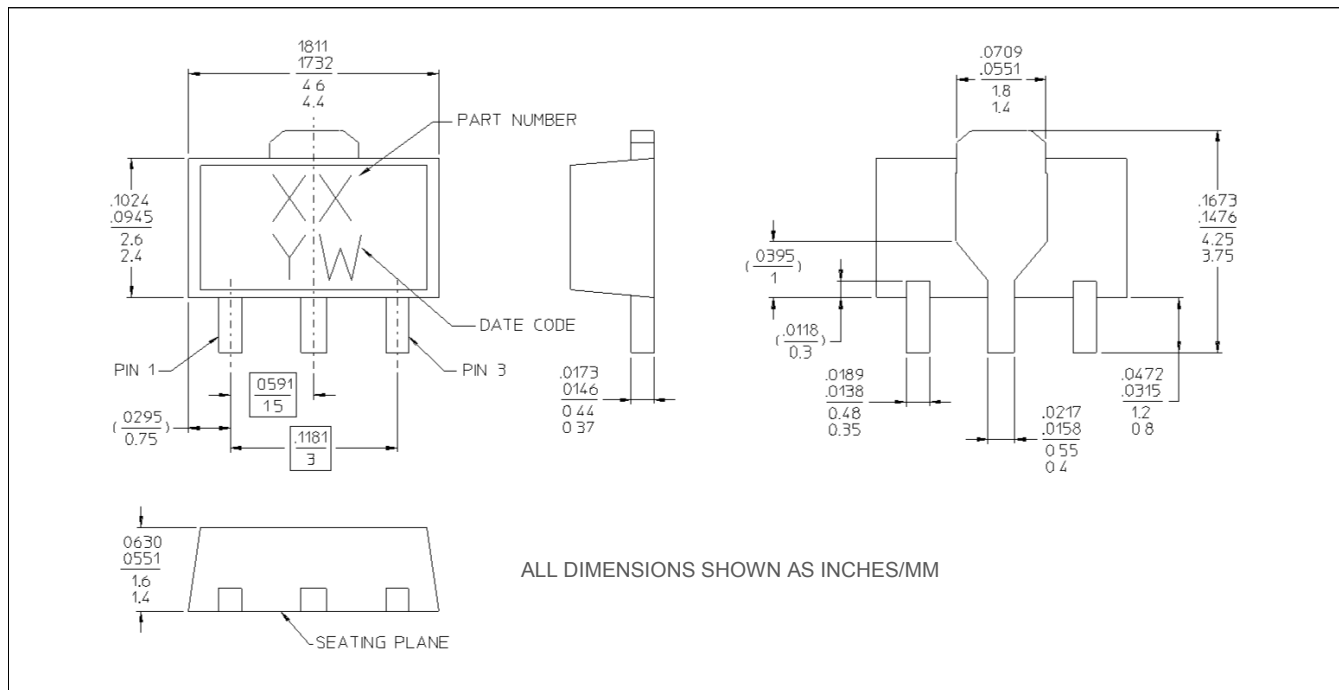

† Reference Application Note S2083 for lead-free solder reflow recommendations.
 Meets JEDEC moisture sensitivity level 1 requirements.
 Plating is 100% matte tin over copper.

Applications Section

3 V Application

The MAAL-011136 may also be operated from 3 V V_{DD} supply with adjustment of two bias resistors: $R4 = 4.64 \text{ k}\Omega$ to set current at nominal 53 mA; and $R6 = 0 \Omega$.

Typical Performance: $T_A = 25^\circ\text{C}$, $V_{DD} = 3 \text{ V}$, $Z_0 = 75 \Omega$

Parameter	Test Conditions	Units	Min.	Typ.	Max.
Gain	45 - 1218 MHz	dB	—	20.5	—
Gain Flatness	45 - 1218 MHz	dB	—	+/- 0.2	—
Reverse Isolation	45 - 1218 MHz	dB	—	25	—
Input Return Loss	45 - 1218 MHz	dB	—	10	—
Output Return Loss	45 - 1218 MHz	dB	—	16	—
Noise Figure	45 - 100 MHz 100 - 1218 MHz	dB	—	1.2 1.2	—
Output IP2	45 - 1200 MHz, tone spacing 6 MHz, P_{OUT} per tone = 4 dBm	dBm	—	42	—
Output IP3	45 - 1200 MHz, tone spacing 6 MHz, P_{OUT} per tone = 4 dBm	dBm	—	32	—
P1dB	45 - 1218 MHz	dBm	—	16.5	—
Composite Triple Beat, CTB	79 channels, 0 dB Tilt, 18 dBmV per channel output, QAM to 1000 MHz	dBc	—	-79	—
Composite Second Order, CSO	79 channels, 0 dB Tilt, 18 dBmV per channel output, QAM to 1000 MHz	dBc	—	-62	—
I_{DD}	$V_{DD} = 3 \text{ V}$	mA	—	53	—

Typical Performance Curves: $V_{DD} = 3\text{ V}$

Gain to 1.218 GHz

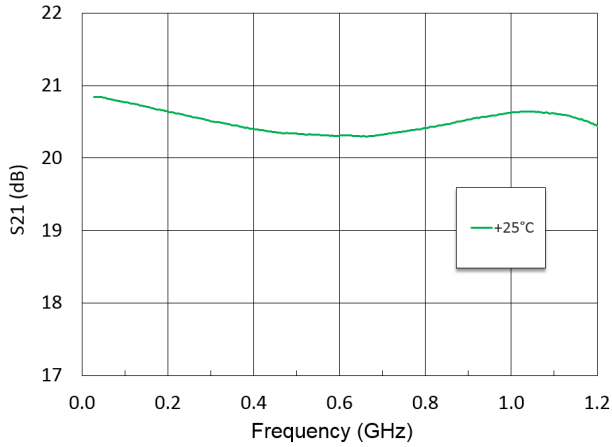

Noise Figure to 1.218 GHz

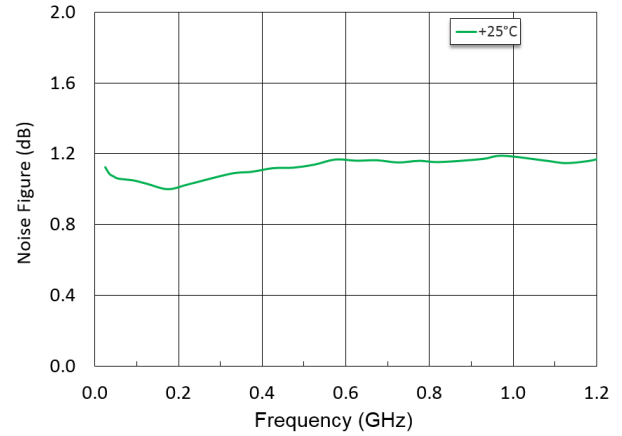

Gain to 3 GHz

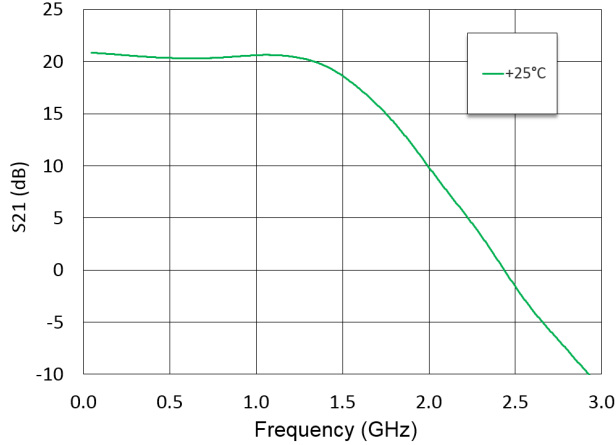

Output Return Loss to 1.218 GHz

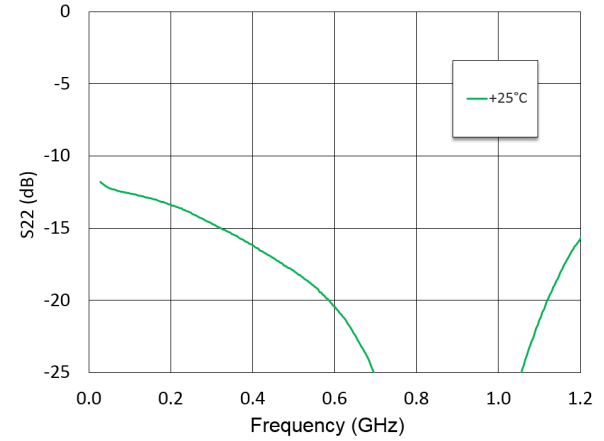

Reverse Isolation to 3 GHz

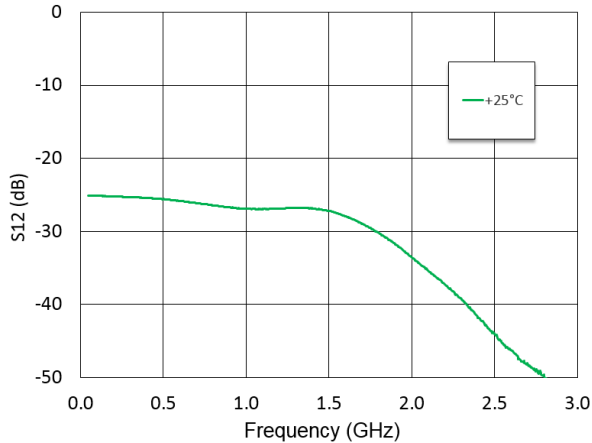

Input Return Loss to 1.218 GHz

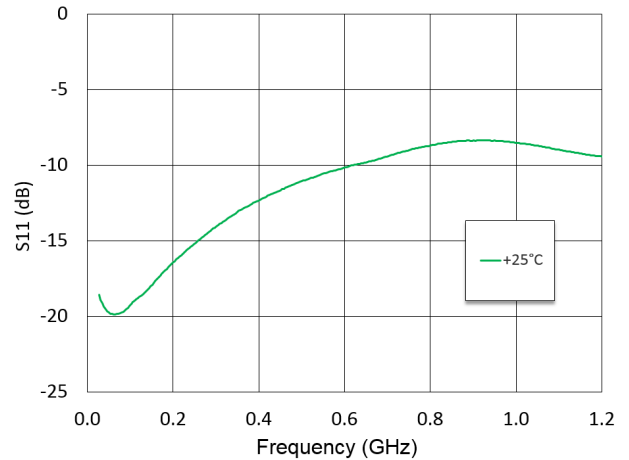

MACOM Technology Solutions Inc. All rights reserved.

Information in this document is provided in connection with MACOM Technology Solutions Inc ("MACOM") products. These materials are provided by MACOM as a service to its customers and may be used for informational purposes only. Except as provided in MACOM's Terms and Conditions of Sale for such products or in any separate agreement related to this document, MACOM assumes no liability whatsoever. MACOM assumes no responsibility for errors or omissions in these materials. MACOM may make changes to specifications and product descriptions at any time, without notice. MACOM makes no commitment to update the information and shall have no responsibility whatsoever for conflicts or incompatibilities arising from future changes to its specifications and product descriptions. No license, express or implied, by estoppel or otherwise, to any intellectual property rights is granted by this document.

THESE MATERIALS ARE PROVIDED "AS IS" WITHOUT WARRANTY OF ANY KIND, EITHER EXPRESS OR IMPLIED, RELATING TO SALE AND/OR USE OF MACOM PRODUCTS INCLUDING LIABILITY OR WARRANTIES RELATING TO FITNESS FOR A PARTICULAR PURPOSE, CONSEQUENTIAL OR INCIDENTAL DAMAGES, MERCHANTABILITY, OR INFRINGEMENT OF ANY PATENT, COPYRIGHT OR OTHER INTELLECTUAL PROPERTY RIGHT. MACOM FURTHER DOES NOT WARRANT THE ACCURACY OR COMPLETENESS OF THE INFORMATION, TEXT, GRAPHICS OR OTHER ITEMS CONTAINED WITHIN THESE MATERIALS. MACOM SHALL NOT BE LIABLE FOR ANY SPECIAL, INDIRECT, INCIDENTAL, OR CONSEQUENTIAL DAMAGES, INCLUDING WITHOUT LIMITATION, LOST REVENUES OR LOST PROFITS, WHICH MAY RESULT FROM THE USE OF THESE MATERIALS.

MACOM products are not intended for use in medical, lifesaving or life sustaining applications. MACOM customers using or selling MACOM products for use in such applications do so at their own risk and agree to fully indemnify MACOM for any damages resulting from such improper use or sale.