

SMD Power Inductor CDRH5D18

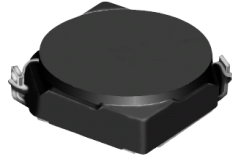
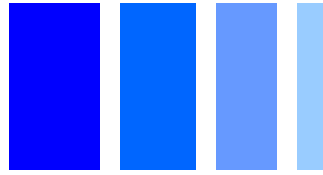

Description

- Ferrite drum core construction.
- Magnetically shielded.
- L × W × H: 6.0 × 6.0 × 2.0 mm Max.
- Product weight: 220mg(Ref.)
- Moisture Sensitivity Level: 1
- RoHS compliance.

Environmental Data

- Operating temperature range: -40°C ~ +100°C (including coil's self temperature rise)
- Storage temperature range: -40°C ~ +100°C
- Solder reflow temperature: 260 °C peak.

Packaging

- Carrier tape and reel packaging
- 13.0" diameter reel
- 2000pcs per reel

Applications

- Ideally used in Mobile phone, MP3, PDA, HDD, DSC/DVC, Game machine, etc as DC-DC converter inductors.

Dimension - [mm]

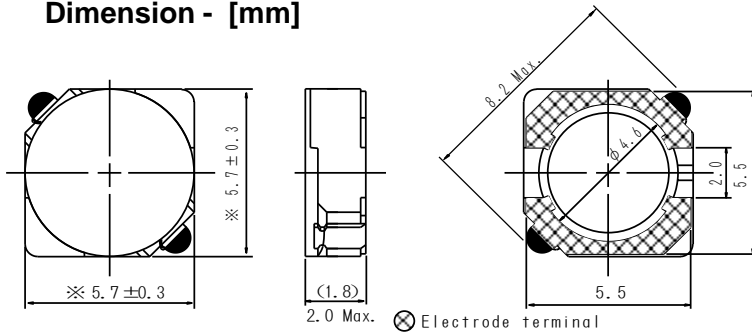

Land pattern and Schematics - [mm]

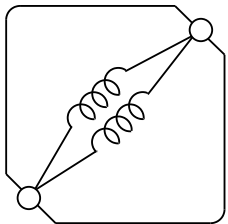
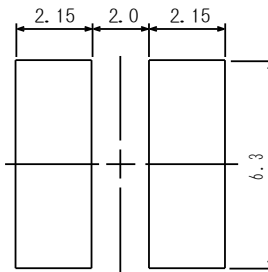

2.2µH

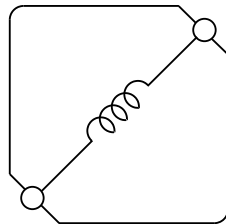

3.3µH ~ 100µH

SMD Power Inductor

CDRH5D18

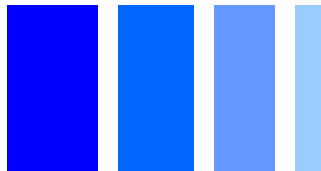

Electrical Characteristics

PART NO.	STAMP	INDUCTANCE (μH) [WITHIN] ※1	D.C.R. (Ω) [MAX.] (TYP.) (at 20°C)※2	RATED CURRENT (A) ※2
CDRH5D18NP-2R2NC	2R2	2.2 $\mu\text{H} \pm 30\%$	37m (27m)	2.4
CDRH5D18NP-3R3NC	3R3	3.3 $\mu\text{H} \pm 30\%$	47m (35m)	2.0
CDRH5D18NP-4R1NC	4R1	4.1 $\mu\text{H} \pm 30\%$	57m (42m)	1.95
CDRH5D18NP-5R4NC	5R4	5.4 $\mu\text{H} \pm 30\%$	76m (56m)	1.60
CDRH5D18NP-6R2NC	6R2	6.2 $\mu\text{H} \pm 30\%$	96m (71m)	1.40
CDRH5D18NP-8R9NC	8R9	8.9 $\mu\text{H} \pm 30\%$	116m (86m)	1.25
CDRH5D18NP-100NC	100	10 $\mu\text{H} \pm 30\%$	124m (92m)	1.20
CDRH5D18NP-120NC	120	12 $\mu\text{H} \pm 30\%$	153m (113m)	1.10
CDRH5D18NP-150NC	150	15 $\mu\text{H} \pm 30\%$	196m (145m)	0.97
CDRH5D18NP-180NC	180	18 $\mu\text{H} \pm 30\%$	210m (155m)	0.85
CDRH5D18NP-220NC	220	22 $\mu\text{H} \pm 30\%$	290m (215m)	0.80
CDRH5D18NP-270NC	270	27 $\mu\text{H} \pm 30\%$	330m (245m)	0.75
CDRH5D18NP-330NC	330	33 $\mu\text{H} \pm 30\%$	385m (285m)	0.65
CDRH5D18NP-390NC	390	39 $\mu\text{H} \pm 30\%$	520m (385m)	0.57
CDRH5D18NP-470NC	470	47 $\mu\text{H} \pm 30\%$	595m (440m)	0.54
CDRH5D18NP-560NC	560	56 $\mu\text{H} \pm 30\%$	665m (493m)	0.50
CDRH5D18NP-680NC	680	68 $\mu\text{H} \pm 30\%$	840m (622m)	0.43
CDRH5D18NP-820NC	820	82 $\mu\text{H} \pm 30\%$	978m (725m)	0.41
CDRH5D18NP-101NC	101	100 $\mu\text{H} \pm 30\%$	1.2 (895m)	0.36

※1. Inductance measuring condition: at 10kHz.

※2. Rated current: The DC current at which the inductance decreases to 65% of it's nominal value or when $\Delta t=30^\circ\text{C}$, whichever is lower ($T_a=20^\circ\text{C}$).

SMD Power Inductor CDRH5D18



Saturation Current & Temperature Rise Graph

— L (20°C) — L (105°C) — ΔT

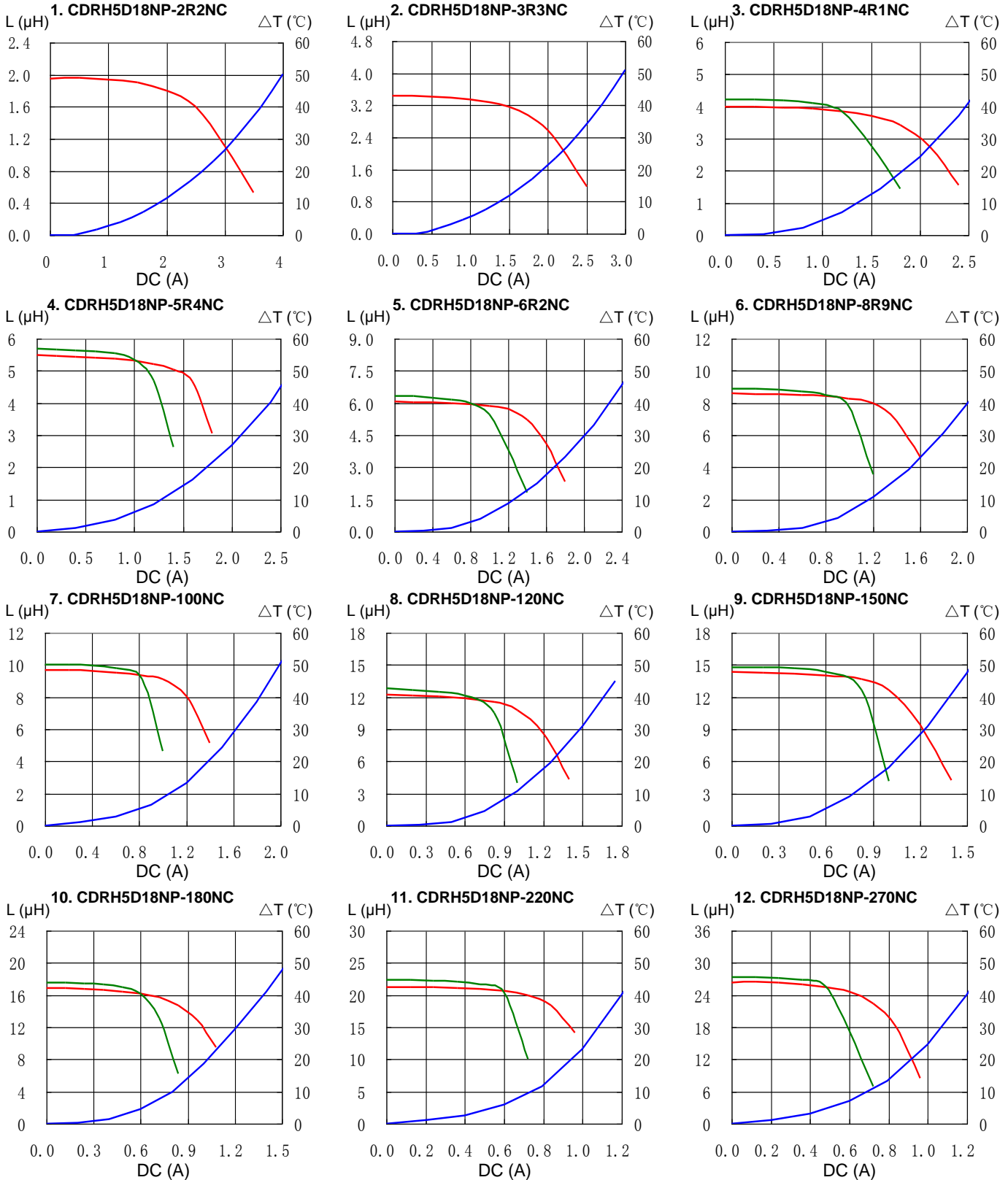

SMD Power Inductor CDRH5D18

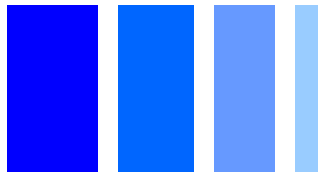

Saturation Current & Temperature Rise Graph

— L (20°C) — L (105°C) — ΔT

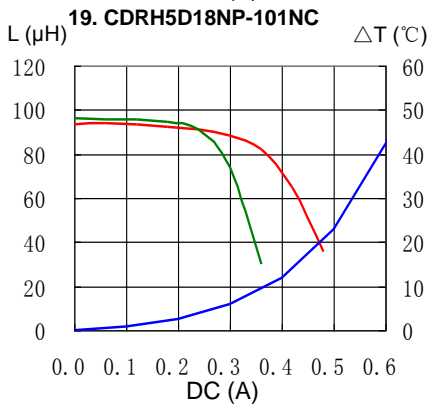
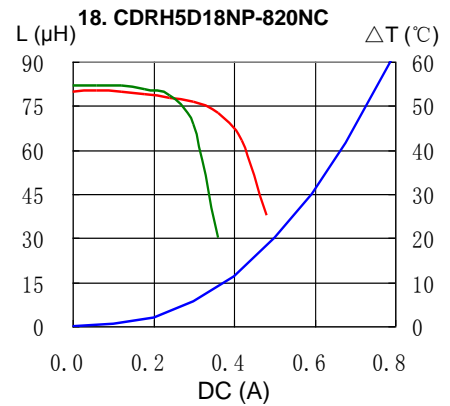
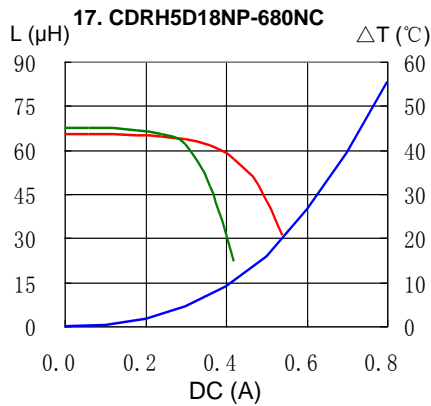
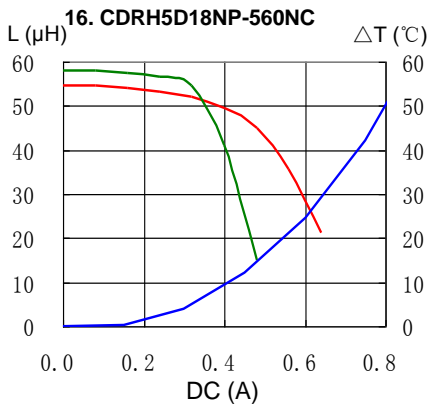
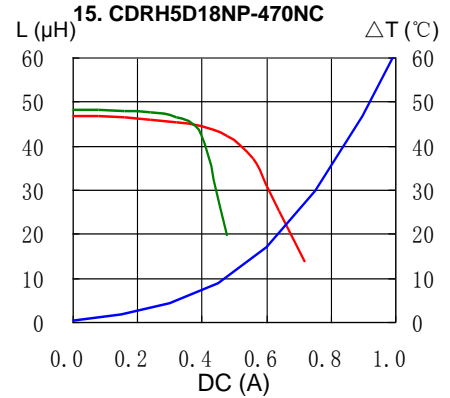
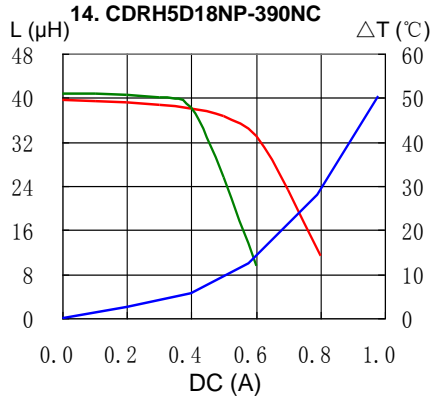
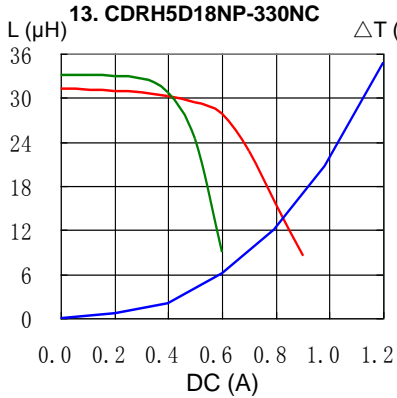

L (μH)

SMD Power Inductor CDRH5D18

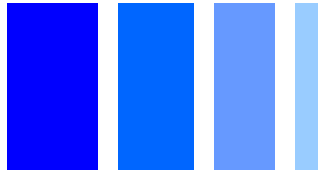

Solder Reflow Condition

Heat Endurance

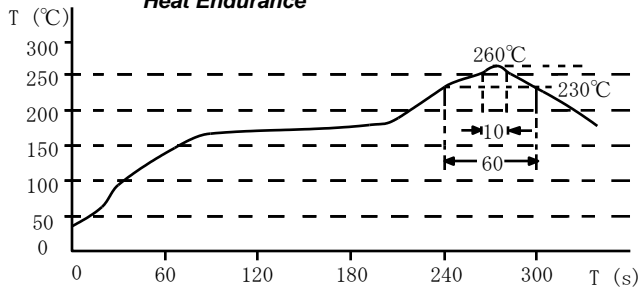

Temperature Chart

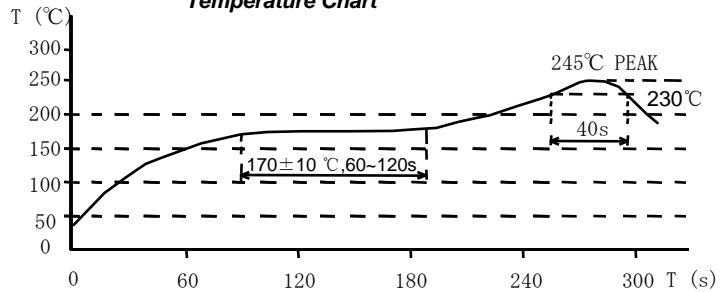

Please refer to the sales offices on our website - <http://www.sumida.com>

Hong Kong

Tel.+852-2880-6781
FAX.+852-2565-9600
sales@hk.sumida.com

Saitama(Japan)

Tel.+81-48-691-7300
FAX.+81-48-691-7340
sales@jp.sumida.com

Chicago

Tel.+1-847-545-6700
FAX. +1-847-545-6720
sales@us.sumida.com

Shanghai

Tel.+86-21-5836-3299
FAX.+86-21-5836-3266
shanghai.sales@cn.sumida.com

Seoul

Tel.+82-2-6237-0777
FAX.+82-2-6237-0778
sales@kr.sumida.com

Obernzell

Tel.+49-8591-937-0
FAX. +49-8591-937-103
contact@eu.sumida.com

Shenzhen

Tel.+86-755-8291-0228
FAX.+86-755-8291-0338
shenzhen.sales@cn.sumida.com

Singapore

Tel.+65-6296-3388
FAX.+65-6841-4426
sales@sg.sumida.com

Neumarkt

Tel.+49-9181-4509-110
FAX. +49-9181-4509-310
infocomp@eu.sumida.com

Taipei

Tel.+886-2-8751-2737
FAX.+886-2-8751-2738
sales@tw.sumida.com

San Jose

Tel.+1-408-321-9660
FAX.+1-408-321-9308
sales@us.sumida.com