

THIS DOCUMENT IS THE PROPERTY OF  
KEYSTONE ELECTRONICS CORP. AND  
SHALL NOT BE REPRODUCED, DISTRIBUTED  
OR USED AS A BASIS FOR MANUFACTURE  
WITHOUT PRIOR WRITTEN PERMISSION  
FROM KEYSTONE ELECTRONICS CORP.

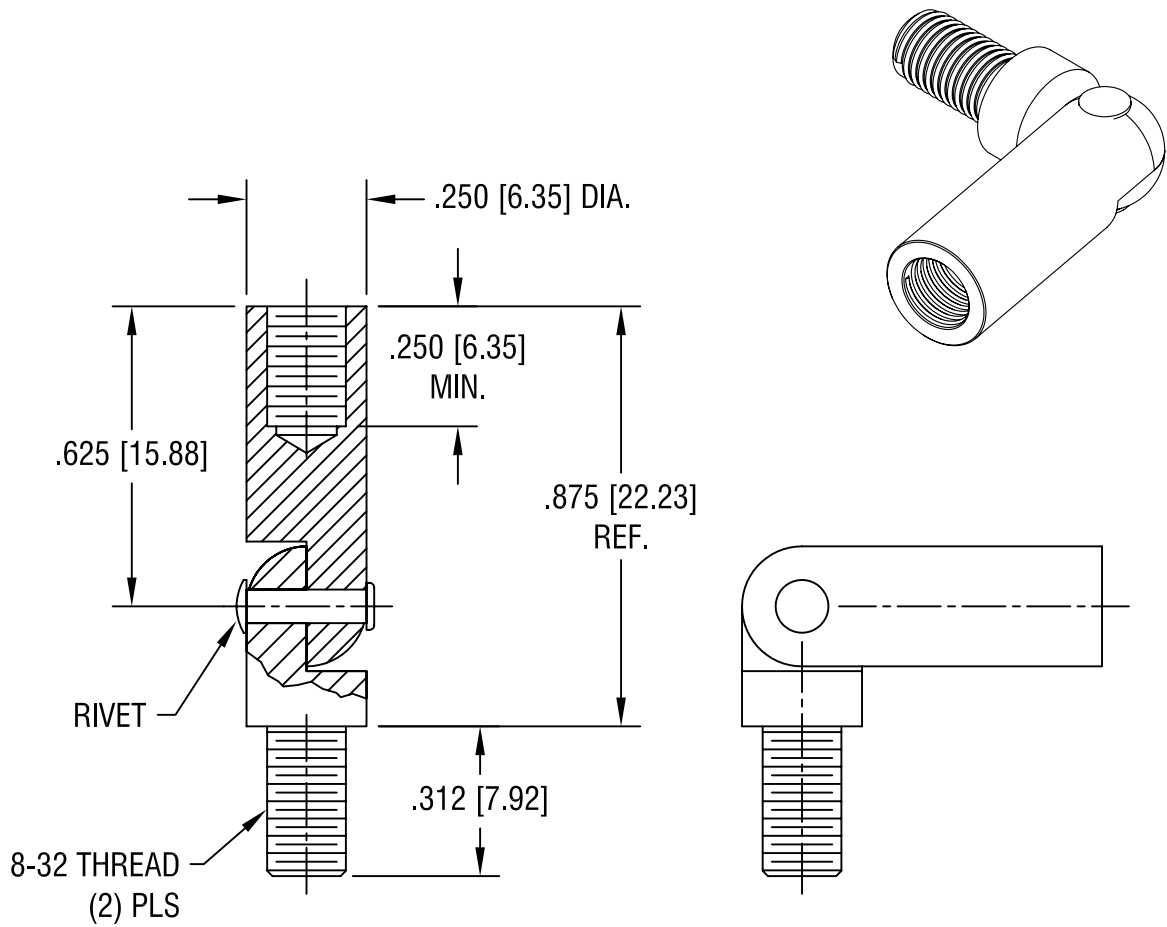

**KEYSTONE ELECTRONICS CORP.**

www.keyelco.com • ASTORIA, N.Y. 11105-2017 • Tel (718) 956-8900

PART NAME

HINGED STANDOFF, MALE/FEMALE

MATERIAL

BRASS

FINISH

ZINC PLATE WITH  
YELLOW CHROMATE

DRN BY

BOONE

DATE

9.18.95

APP'D

LN

SCALE

2.5X

9.08.08 CHANGE AS PER ECN 08-148

A

TOLERANCES

INCH [MM]

CODE

DWG NO.

DECIMAL

$\pm .005$  [ $\pm 0.15$ ]

C

ANGULAR

$\pm 1^\circ$

UNLESS OTHERWISE SPECIFIED

**338**

DATE

DESCRIPTION

REV.