

n-Channel Power MOSFET

OptiMOS™
BSF077N06NT3 G

Data Sheet

1.4, 2011-03-01
Preliminary

Industrial & Multimarket

1 Description

OptiMOS™60V products are class leading power MOSFETs for highest power density and energy efficient solutions. Ultra low gate- and output charges together with lowest on state resistance in small footprint packages make OptiMOS™ 60V the best choice for the demanding requirements of switched mode power supplies in Servers, Datacom and Telecom applications but also for motor drives. With almost no parasitic package inductances, the CanPAK allows best controllability of the gate in highly dynamic switching environments. This package in addition features best cooling capability through top-side cooling of the metal can. Hence, this packaging technology combined with the OptiMOS silicon enables highest efficiency levels while having minimal space requirements at the same time

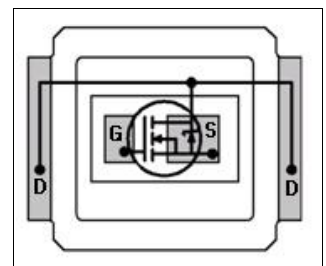

Features

- Optimized technology for DC/DC converters
- 100% avalanche tested
- Excellent gate charge x $R_{DS(on)}$ product (FOM)
- Qualified according to JEDEC¹⁾ for target applications
- Superior thermal resistance
- Pb-free plating; RoHS compliant
- Halogen-free according to IEC61249-2-21
- Double.sided cooling
- Compatible with DirectFET® package ST footprint and outline
- Low profile (<0.7mm)
- Low parasitic inductance

Applications

- DC/DC converters
- Synchronous rectification
- Power distribution
- Motor drive applications



Table 1 Key Performance Parameters

Parameter	Value	Unit	Related Links
V_{DS}	60	V	IFX OptiMOS webpage IFX OptiMOS product brief IFX OptiMOS spice models IFX Design tools
$R_{DS(on),max}$	7.7	mΩ	
I_D	56	A	
Q_{OSS}	28	nC	
$Q_{g,typ}$	34		

Type	Package	Marking
BSF077N06NT3 G	MG-WDSO-2	0206

1) J-STD20 and JESD22

2 Maximum ratings

at $T_j = 25\text{ °C}$, unless otherwise specified.

Table 2 Maximum ratings

Parameter	Symbol	Values			Unit	Note / Test Condition
		Min.	Typ.	Max.		
Continuous drain current	I_D	-	-	56	A	$V_{GS}=10\text{ V}, T_C=25\text{ °C}$
				36		$V_{GS}=10\text{ V}, T_C=100\text{ °C}$
				13		$V_{GS}=10\text{ V}, T_A=25\text{ °C}, R_{thJA}=58\text{ K/W}^{(1)}$
Pulsed drain current ²⁾	$I_{D,pulse}$	-	-	224		$T_C=25\text{ °C}$
Avalanche energy, single pulse	E_{AS}	-	-	150	mJ	$I_D=30\text{ A}, R_{GS}=25\text{ }\Omega$
Gate source voltage	V_{GS}	-20	-	20	V	
Power dissipation	P_{tot}	-	-	38	W	$T_C=25\text{ °C}$
				2.2		$T_A=25\text{ °C}, R_{thJA}=58\text{ K/W}^{(3)}$
Operating and storage temperature	T_j, T_{stg}	-40	-	150	°C	
IEC climatic category; DIN IEC 68-1		55	150	56	Ncm	

- 1) DirectFET® is a trademark of International Rectifier Corporation. BSF077N06NT3 G uses DirectFET® technology licensed from International Rectifier Corporation.
- 2) See figure 3 for more detailed information
- 3) Device on 40 mm x 40 mm x 1.5 mm epoxy PCB FR4 with 6 cm² (one layer, 70µm thick) copper area for drain connection. PCB is vertical in still air.

3 Thermal characteristics

Table 3 Thermal characteristics

Parameter	Symbol	Values			Unit	Note / Test Condition
		Min.	Typ.	Max.		
Thermal resistance, junction - case	R_{thJC}	-	1.0	-	°K/W	bottom
			3.3	-		top
Device on PCB	R_{thJA}	-	-	58		6 cm ² cooling area ¹⁾

- 1) Device on 40 mm x 40 mm x 1.5 mm epoxy PCB FR4 with 6 cm² (one layer, 70µm thick) copper area for drain connection. PCB is vertical in still air

4 Electrical characteristics

Electrical characteristics, at $T_J=25\text{ °C}$, unless otherwise specified.

Table 4 Static characteristics

Parameter	Symbol	Values			Unit	Note / Test Condition
		Min.	Typ.	Max.		
Drain-source breakdown voltage	$V_{(BR)DSS}$	60	15	-	V	$V_{GS}=0\text{ V}$, $I_D=1\text{ mA}$
Gate threshold voltage	$V_{GS(th)}$	2	3	4		$V_{DS}=V_{GS}$, $I_D=33\text{ }\mu\text{A}$
Zero gate voltage drain current	I_{DSS}	-	0.1	10	μA	$V_{DS}=30\text{ V}$, $V_{GS}=0\text{ V}$, $T_J=25\text{ °C}$
		-	10	100		$V_{DS}=60\text{ V}$, $V_{GS}=0\text{ V}$, $T_J=125\text{ °C}$
Gate-source leakage current	I_{GSS}	-	10	100	nA	$V_{GS}=20\text{ V}$, $V_{DS}=0\text{ V}$
Drain-source on-state resistance	$R_{DS(on)}$	-	6.6	7.7	$\text{m}\Omega$	$V_{GS}=10\text{ V}$, $I_D=30\text{ A}$
Gate resistance	R_G	-	0.5	-	Ω	
Transconductance	g_{fs}	23	46		S	$ V_{DS} >2 I_{D RDS(on)max}$, $I_D=30\text{ A}$

Table 5 Dynamic characteristics

Parameter	Symbol	Values			Unit	Note / Test Condition
		Min.	Typ.	Max.		
Input capacitance	C_{iss}	-	2800	3700	pF	$V_{GS}=0\text{ V}$, $V_{DS}=30\text{ V}$, $f=1\text{ MHz}$
Output capacitance	C_{oss}	-	800	1060		
Reverse transfer capacitance	C_{rss}	-	22	-		
Turn-on delay time	$t_{d(on)}$	-	12	-	ns	$V_{DD}=30\text{ V}$, $V_{GS}=10\text{ V}$, $I_D=30\text{ A}$, $R_G=1.6\text{ }\Omega$
Rise time	t_r	-	4	-		
Turn-off delay time	$t_{d(off)}$	-	18	-		
Fall time	t_f	-	3	-		

Table 6 Gate charge characteristics¹⁾

Parameter	Symbol	Values			Unit	Note / Test Condition
		Min.	Typ.	Max.		
Gate to source charge	Q_{gs}	-	15	-	nC	$V_{DD}=30\text{ V}$, $I_D=30\text{ A}$, $V_{GS}=0\text{ to }10\text{ V}$
Gate to drain charge	Q_{gd}	-	3	-		
Switching charge	Q_{sw}	-	15	-		
Gate charge total	Q_g	-	34	46		
Gate plateau voltage	$V_{plateau}$	-	5.2	-	V	
Output charge	Q_{oss}		28	37		$V_{DD}=30\text{ V}$, $V_{GS}=0\text{ V}$

1) See figure 16 for gate charge parameter definition

Table 7 Reverse diode characteristics

Parameter	Symbol	Values			Unit	Note / Test Condition
		Min.	Typ.	Max.		
Diode continuous forward current	I_s			30	A	$T_C=25\text{ °C}$
Diode pulse current	$I_{S,pulse}$			120		
Diode forward voltage	V_{SD}	-	0.9	1.2	V	$V_{GS}=0\text{ V}$, $I_F=30\text{ A}$, $T_j=25\text{ °C}$
Reverse recovery charge	Q_{rr}	-	56	-	nC	$V_R=30\text{ V}$, $I_F=I_s$,
Reverse recovery time	t_{rr}	-	41	-	ns	$di_F/dt=400\text{ A}/\mu\text{s}$

5 Electrical characteristics diagrams

Table 8

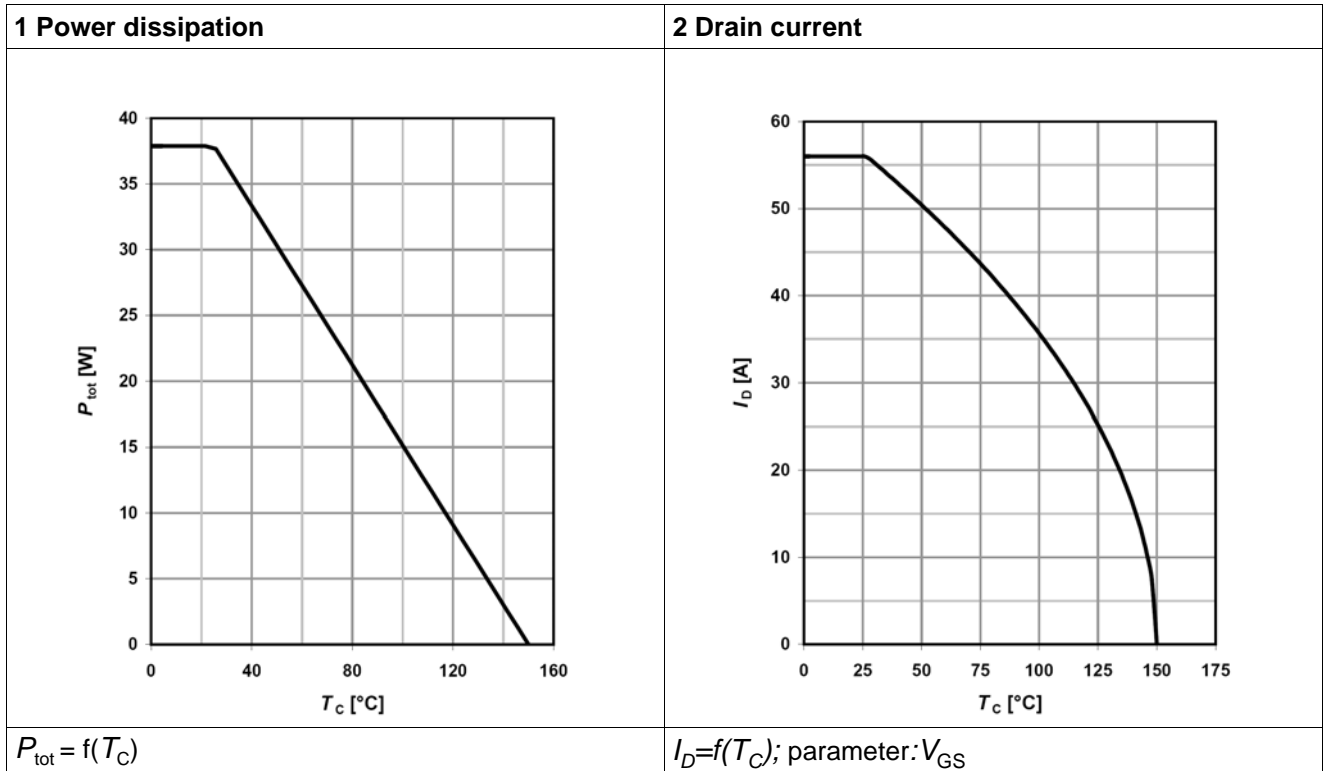

Table 9

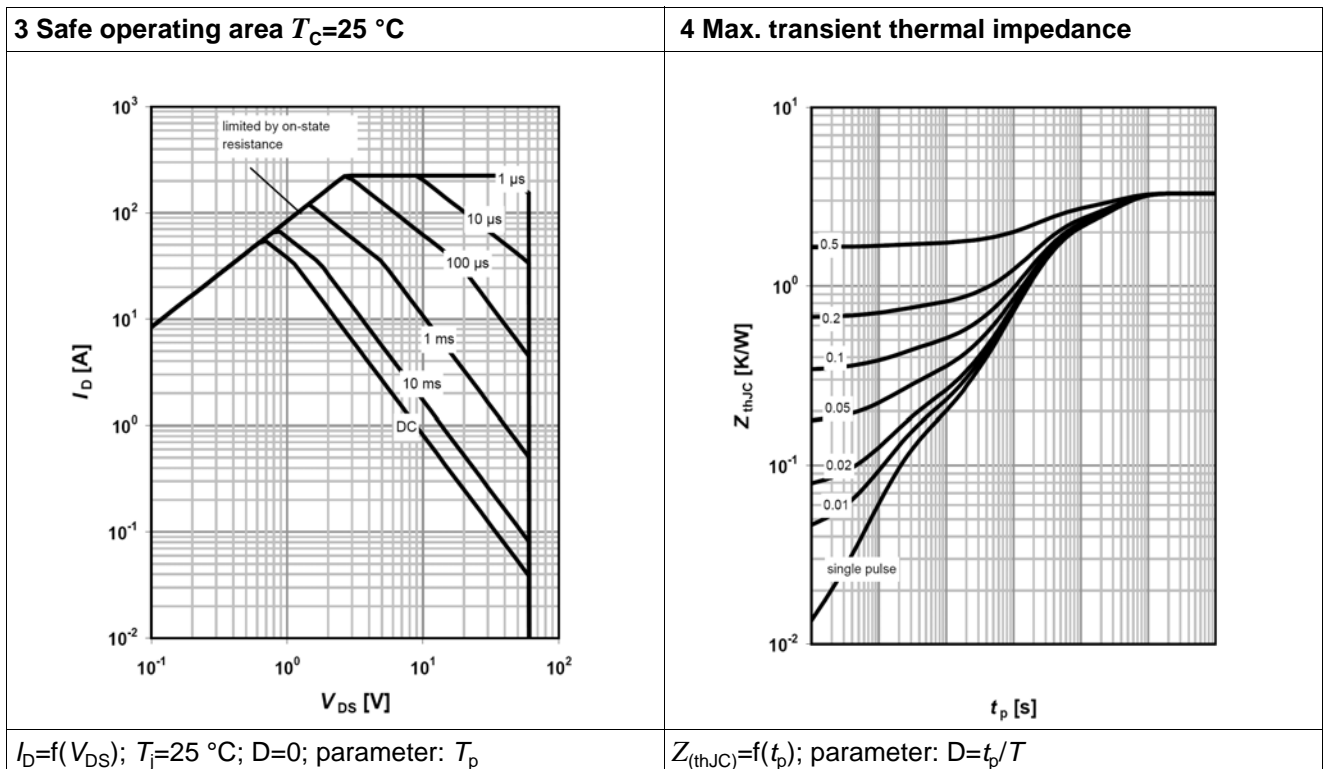

Table 10

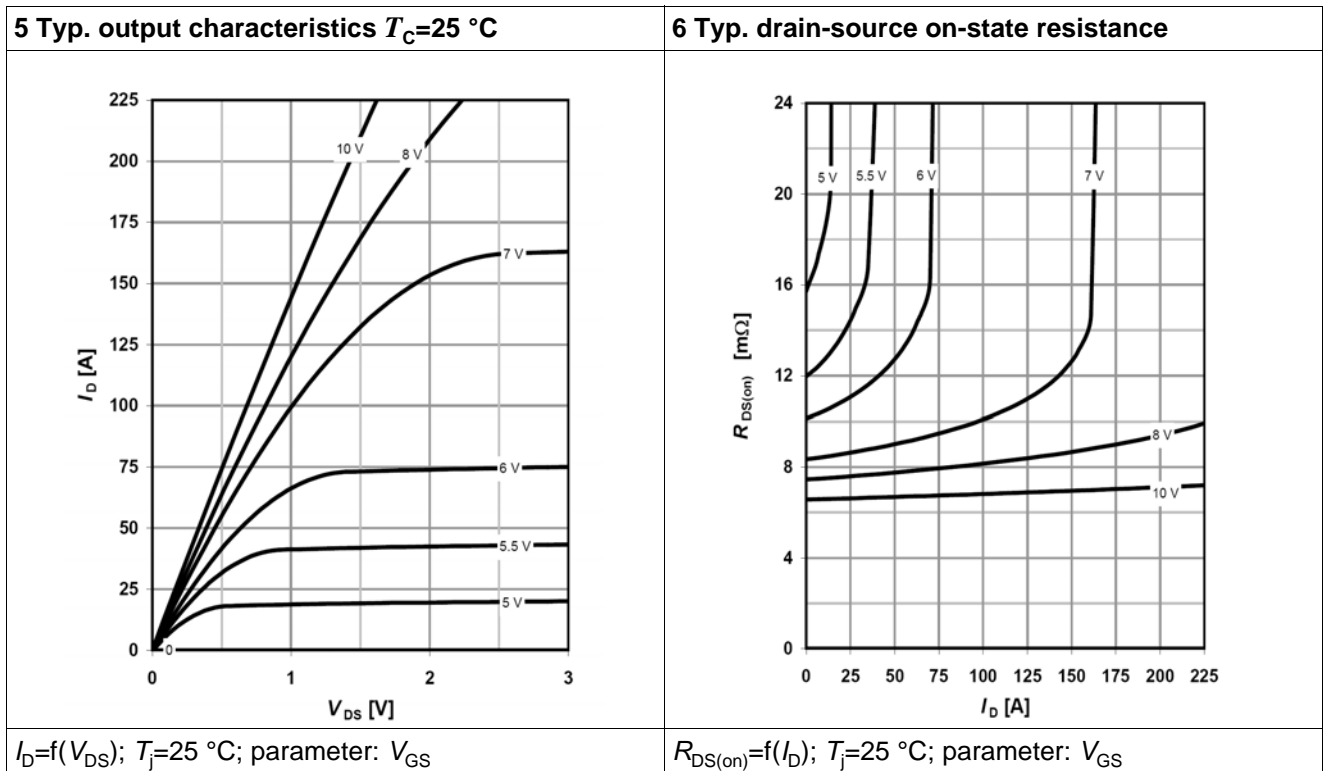

Table 11

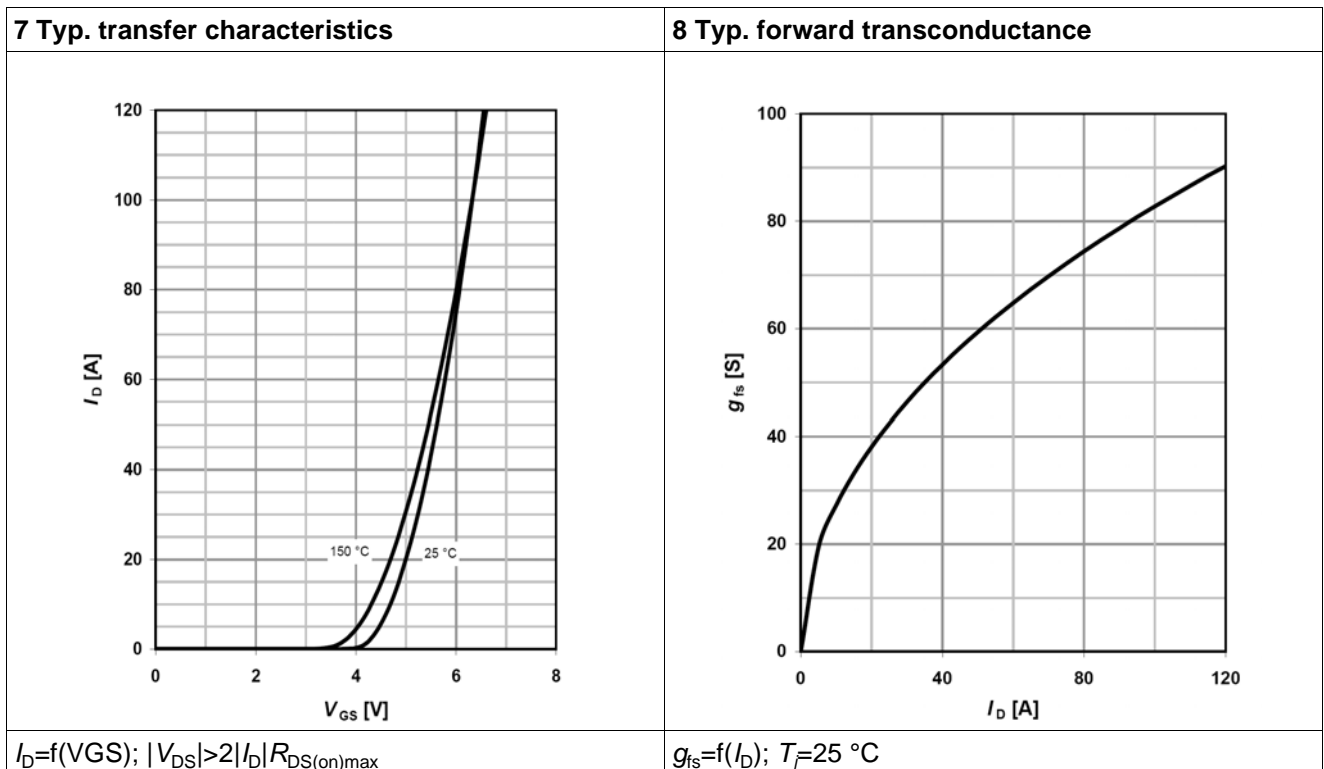

Table 12

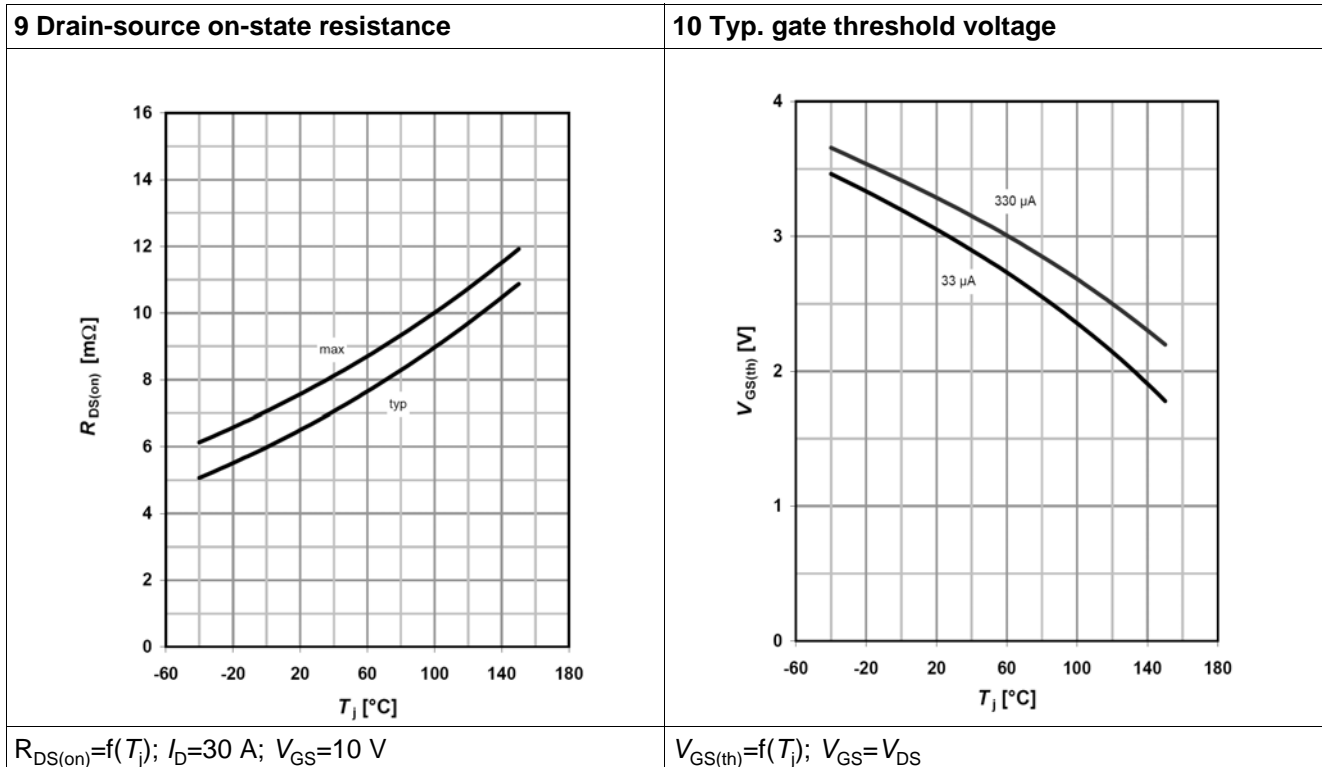

Table 13

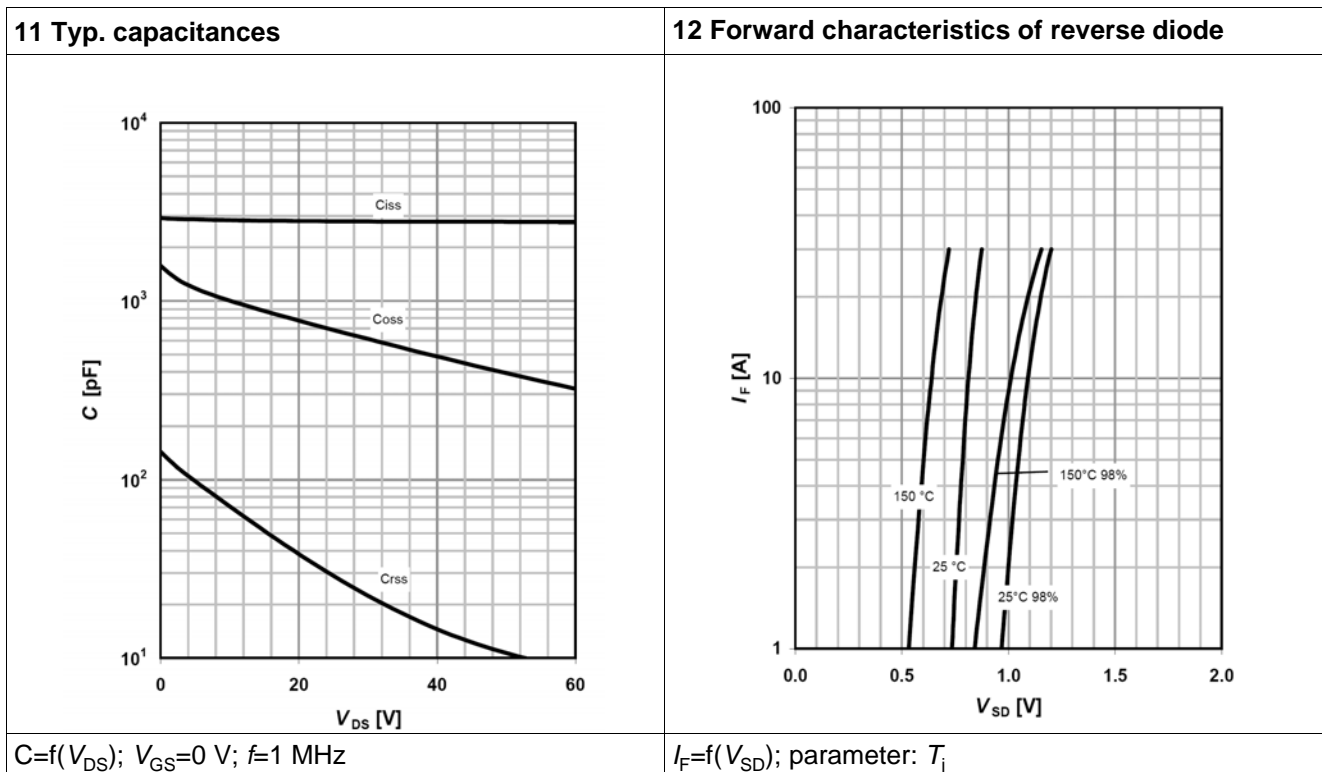

Table 14

13 Avalanche characteristics	14 Typ. gate charge
$I_{AS}=f(t_{AV}); R_{GS}=25 \Omega; \text{parameter: } T_{j(\text{start})}$	$V_{GS}=f(Q_{\text{gate}}); I_D=30 \text{ A pulsed}; \text{parameter: } V_{DD}$

Table 15

15 Drain-source breakdown voltage	16 Gate charge waveforms
$V_{BR(DSS)}=f(T_j); I_D=1 \text{ mA}$	

6 Package outlines

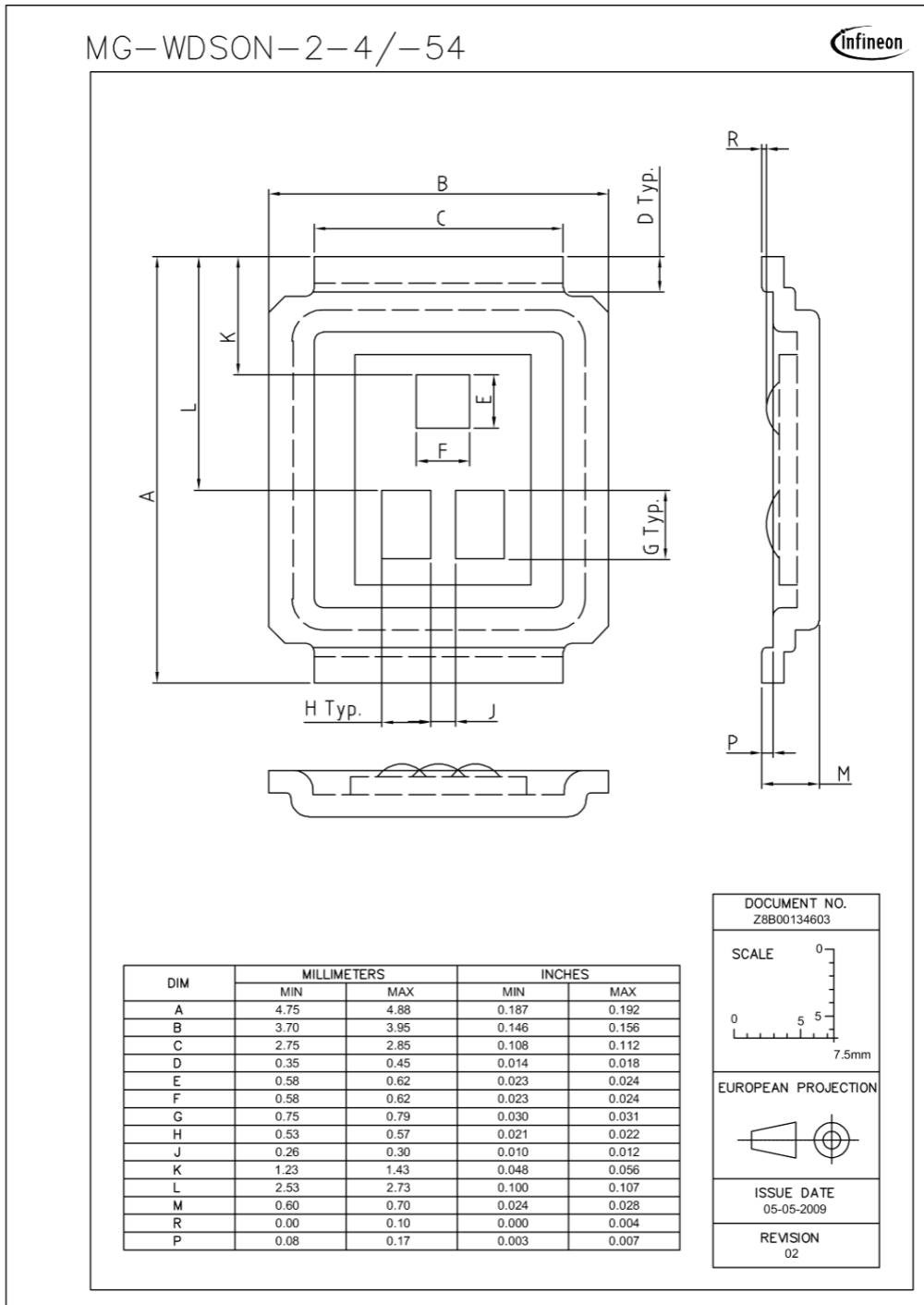

Figure 1 Outlines MG-WDSO-2, dimensions in mm/inches

7 Package outlines

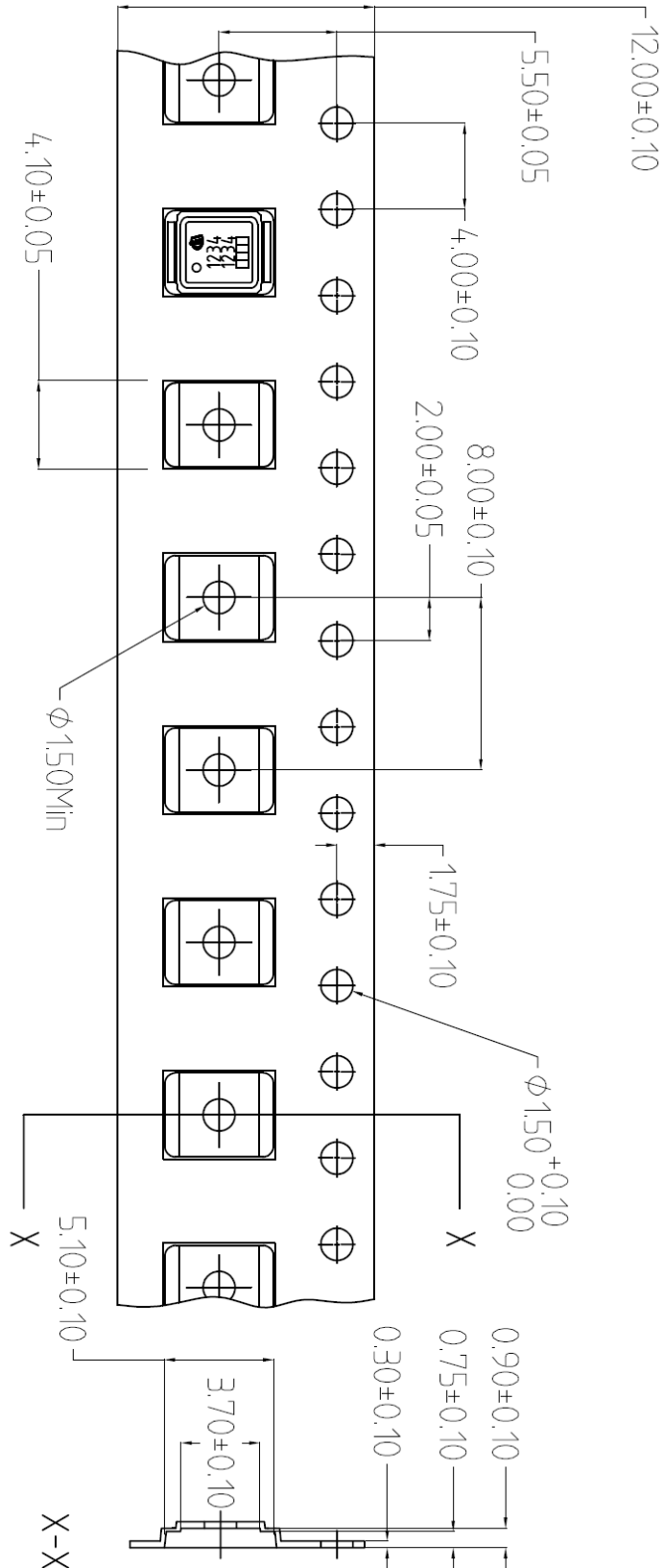
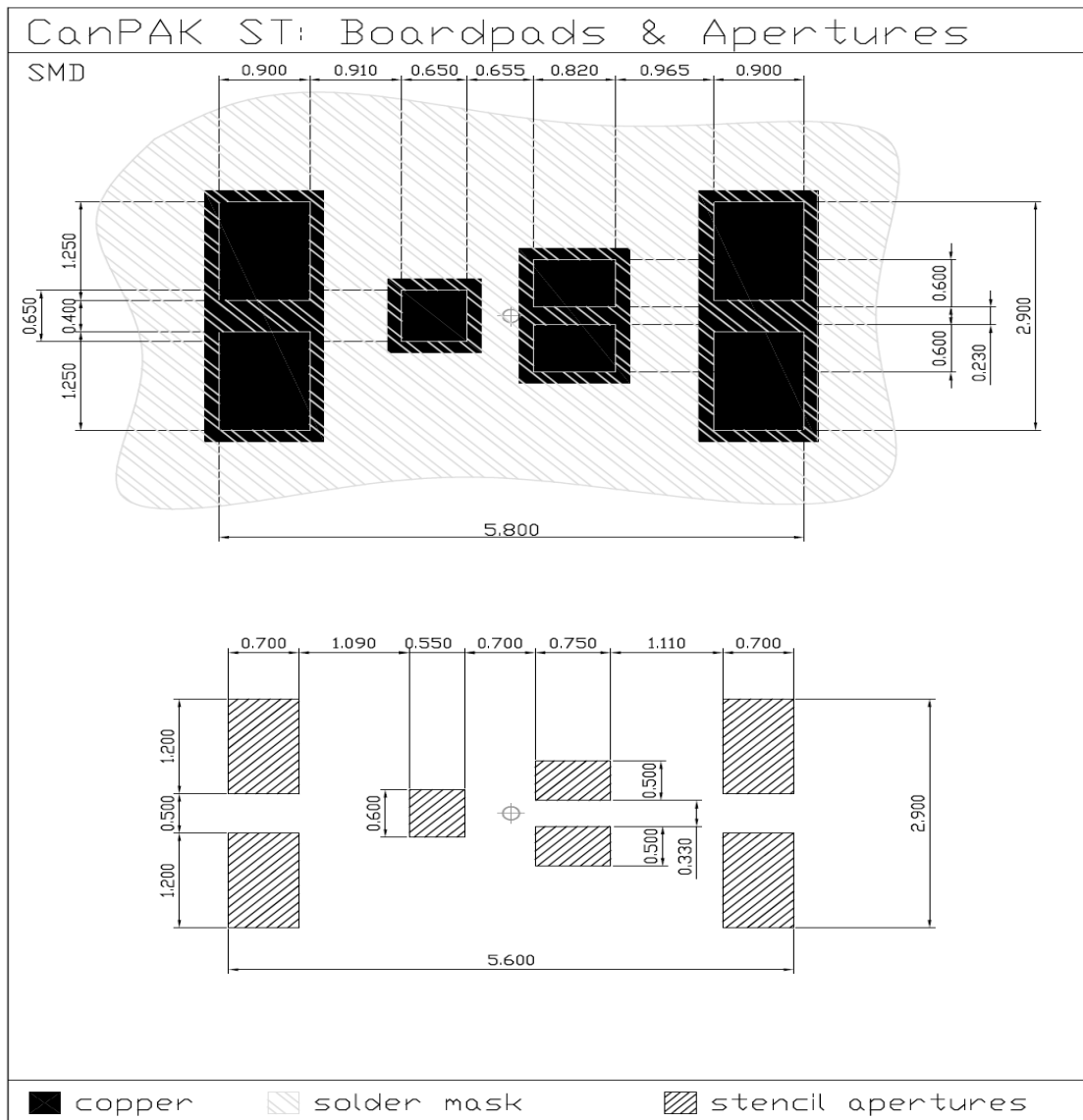
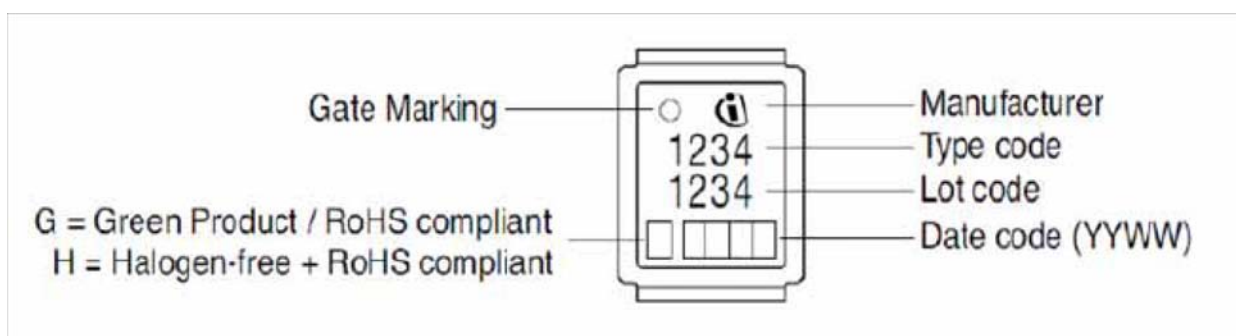

Figure 2 Outlines MG-WDSO-2, dimensions in mm/inches

8 Package outlines



9 Marking layout



9 Revision History

Revision History: 2011-03-01, 1.4

Previous Revision:

Revision	Subjects (major changes since last revision)
0.1	Release of target data sheet
1.0	Release Preliminary data sheet
1.3	DirectFET Disclaimer expired
1.4	Insert Marking layout

We Listen to Your Comments

Any information within this document that you feel is wrong, unclear or missing at all?

Your feedback will help us to continuously improve the quality of this document.

Please send your proposal (including a reference to this document) to: erratum@infineon.com



Edition 2011-03-01

Published by

Infineon Technologies AG

81726 Munich, Germany

© 2011 Infineon Technologies AG

All Rights Reserved.

Legal Disclaimer

The information given in this document shall in no event be regarded as a guarantee of conditions or characteristics. With respect to any examples or hints given herein, any typical values stated herein and/or any information regarding the application of the device, Infineon Technologies hereby disclaims any and all warranties and liabilities of any kind, including without limitation, warranties of non-infringement of intellectual property rights of any third party.

Information

For further information on technology, delivery terms and conditions and prices, please contact the nearest Infineon Technologies Office (www.infineon.com).

Warnings

Due to technical requirements, components may contain dangerous substances. For information on the types in question, please contact the nearest Infineon Technologies Office.

The Infineon Technologies component described in this Data Sheet may be used in life-support devices or systems and/or automotive, aviation and aerospace applications or systems only with the express written approval of Infineon Technologies, if a failure of such components can reasonably be expected to cause the failure of that life-support, automotive, aviation and aerospace device or system or to affect the safety or effectiveness of that device or system. Life support devices or systems are intended to be implanted in the human body or to support and/or maintain and sustain and/or protect human life. If they fail, it is reasonable to assume that the health of the user or other persons may be endangered