

SS-A5 SERIES SH SERIES

Related Information

- General terms and conditions..... P.1
- Sensor selection guide P.11~ / P.229~
- SH Specifications / Precautions / Dimensions .. P.385~
- Glossary of terms / General precautions ... P.983~ / P.986~

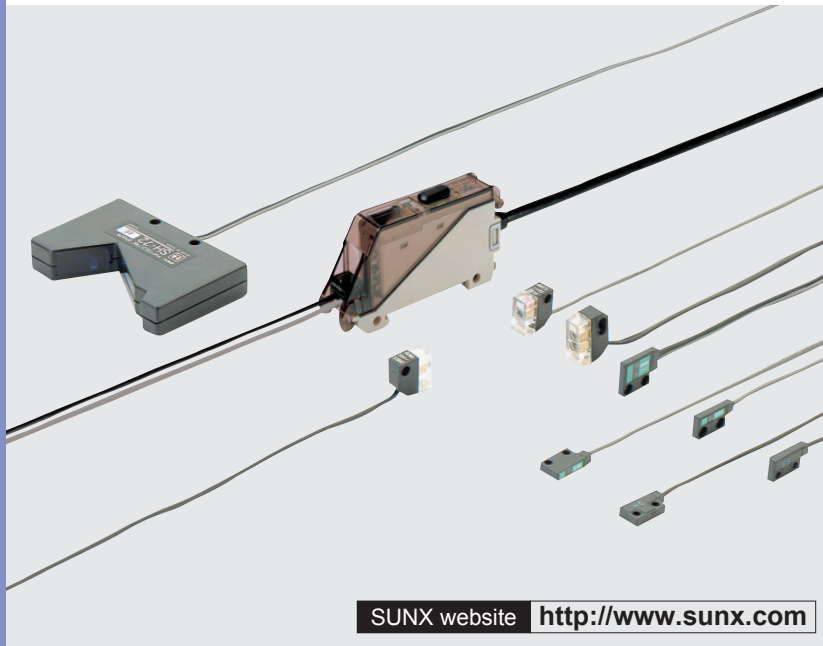

SUNX website <http://www.sunx.com>



Twin adjuster enables delicate sensitivity setting

Twin adjuster

Its twin adjuster enables easy optimum setting to suit the application.

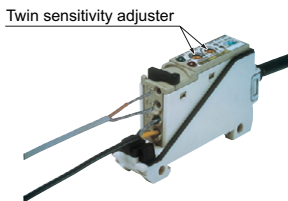

FUNCTIONS

Automatic interference prevention

The **SS-A5** amplifier is incorporated with an automatic interference prevention function. Mutual interference does not occur even if two sensors are mounted adjacently.

OFF-delay timer

An OFF-delay timer which extends the output signal by a fixed period is incorporated. This is useful when the connected device has a slow response time or when small objects are being sensed and the output signal width is too small.

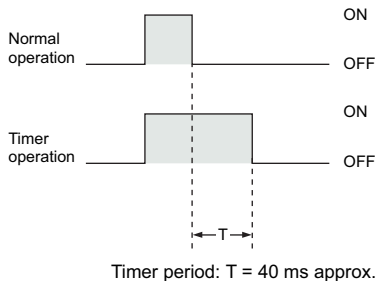

VARIETIES

Ultra-slim type

SH-2

Compact size: 0.3 cm³

Thickness: 3 mm 0.118 in

Versatile mounting

- Diffuse reflective type sensor head
- Front sensing
- Thru-beam type sensor head
- Front sensing • Side sensing



Ultra-small type

SH-3

Sensor head with indicator

An operation indicator, which enables an easy check of the operation at site, has been incorporated.

2 m 6.562 ft long sensing range with red LED beam (SH-33R)
Visible red LED beam makes alignment easy.



Glass substrate detection sensor

SH-72

Reliable glass substrate detection

Its unique optical system enables stable detection of transparent glass substrate, as well as, specular film deposited glass substrate at the same distance.

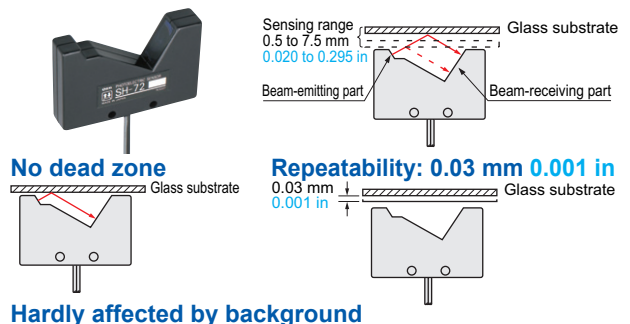

Selection Guide
Amplifier Built-in
CX-400
EX-10
EX-20
EX-30
EX-40
EQ-30
EQ-500
MQ-W
RX-LS200
RX
CY
PX-2
RT-610
Power Supply Built-in
NX5
VF
Amplifier-separated
SU-7 / SH
SS-A5 / SH
Other Products

APPLICATIONS

Detecting ICs in transparent sticks

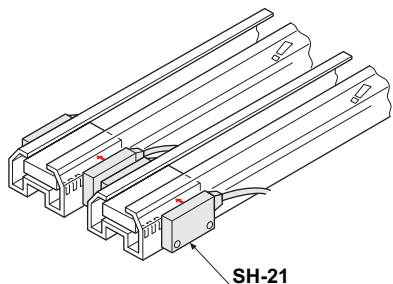

Detecting small bottles

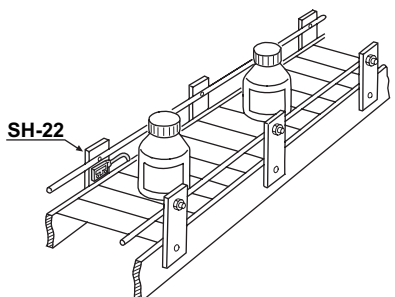

Sensing remaining tape

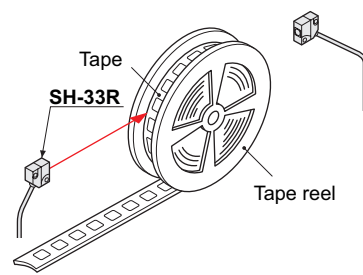

ORDER GUIDE

Amplifiers

Type	Appearance	Model No.	Sensing output
3 m 9.843 ft cable length type		SS-A5	NPN open-collector transistor
5 m 16.404 ft cable length type		SS-A5-C5	

Accessory

- MS-DIN-1 (Amplifier mounting bracket)

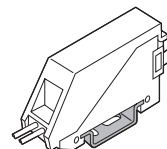

Sensor heads

Type	Appearance	Sensing range	Model No. (Note 1)	Emitting element	Operation indicator
Ultra-slim	Thru-beam Front sensing		SH-21	Infrared LED	—
	Thru-beam Side sensing		SH-21E		
	Diffuse reflective Front sensing		SH-22		
Ultra-small	Thru-beam		SH-31R	Red LED	Incorporated
			SH-31G	Green LED	
			SH-33R	Red LED	
	Diffuse reflective		SH-32R	Red LED	
Glass substrate detection sensor		SH-72		Infrared LED	—

Notes: 1) The model No. with suffix "P" shown on the label affixed to the thru-beam type sensor is the emitter, "D" shown on the label is the receiver. (e.g.) Emitter of **SH-31R**: **SH-31RP**, Receiver of **SH-31R**: **SH-31RD**
 2) Refer to p.385~ for specifications of sensor head, p.390 for precautions of sensor head and p.393~ for dimensions of sensor head.

- FIBER SENSORS
- LASER SENSORS
- PHOTO-ELECTRIC SENSORS
- MICRO PHOTO-ELECTRIC SENSORS
- AREA SENSORS
- SAFETY COMPONENTS
- PRESSURE SENSORS
- INDUCTIVE PROXIMITY SENSORS
- PARTICULAR USE SENSORS
- SENSOR OPTIONS
- WIRE-SAVING SYSTEMS
- MEASUREMENT SENSORS
- STATIC CONTROL DEVICES
- LASER MARKERS

- Selection Guide
- Amplifier Built-in
- CX-400**
- EX-10**
- EX-20**
- EX-30**
- EX-40**
- EQ-30**
- EQ-500**
- MQ-W**
- RX-LS200**
- RX**
- CY**
- PX-2**
- RT-610**
- Power Supply Built-in
- NX5**
- VF**
- Amplifier-separated
- SU-7 / SH**
- SS-A5 / SH**
- Other Products

OPTIONS

Designation	Model No.	Description																															
Slit mask (For SH-31R , SH-31G and SH-33R only)	OS-SS3	This is a convenient slit mask having four types of slit masks.																															
		<table border="1"> <thead> <tr> <th rowspan="2">Slit size</th> <th rowspan="2">Fitting</th> <th colspan="3">Sensing range</th> <th rowspan="2">Min. sensing object</th> </tr> <tr> <th>SH-31R</th> <th>SH-31G</th> <th>SH-33R</th> </tr> </thead> <tbody> <tr> <td rowspan="2">0.5 × 3 mm 0.020 × 0.118 in</td> <td>One side</td> <td>500 mm 19.685 in</td> <td>50 mm 1.969 in</td> <td>750 mm 29.528 in</td> <td>ø3 mm ø0.118 in</td> </tr> <tr> <td>Both sides</td> <td>250 mm 9.843 in</td> <td>25 mm 0.984 in</td> <td>400 mm 15.748 in</td> <td>0.5 × 3 mm 0.020 × 0.118 in</td> </tr> <tr> <td rowspan="2">1 × 3 mm 0.039 × 0.118 in</td> <td>One side</td> <td>700 mm 27.559 in</td> <td>70 mm 2.756 in</td> <td>1,000 mm 39.370 in</td> <td>ø3 mm ø0.118 in</td> </tr> <tr> <td>Both sides</td> <td>500 mm 19.685 in</td> <td>50 mm 1.969 in</td> <td>750 mm 29.528 in</td> <td>1 × 3 mm 0.039 × 0.118 in</td> </tr> </tbody> </table>	Slit size	Fitting	Sensing range			Min. sensing object	SH-31R	SH-31G	SH-33R	0.5 × 3 mm 0.020 × 0.118 in	One side	500 mm 19.685 in	50 mm 1.969 in	750 mm 29.528 in	ø3 mm ø0.118 in	Both sides	250 mm 9.843 in	25 mm 0.984 in	400 mm 15.748 in	0.5 × 3 mm 0.020 × 0.118 in	1 × 3 mm 0.039 × 0.118 in	One side	700 mm 27.559 in	70 mm 2.756 in	1,000 mm 39.370 in	ø3 mm ø0.118 in	Both sides	500 mm 19.685 in	50 mm 1.969 in	750 mm 29.528 in	1 × 3 mm 0.039 × 0.118 in
		Slit size			Fitting	Sensing range			Min. sensing object																								
			SH-31R	SH-31G		SH-33R																											
		0.5 × 3 mm 0.020 × 0.118 in	One side	500 mm 19.685 in	50 mm 1.969 in	750 mm 29.528 in	ø3 mm ø0.118 in																										
			Both sides	250 mm 9.843 in	25 mm 0.984 in	400 mm 15.748 in	0.5 × 3 mm 0.020 × 0.118 in																										
1 × 3 mm 0.039 × 0.118 in	One side	700 mm 27.559 in	70 mm 2.756 in	1,000 mm 39.370 in	ø3 mm ø0.118 in																												
	Both sides	500 mm 19.685 in	50 mm 1.969 in	750 mm 29.528 in	1 × 3 mm 0.039 × 0.118 in																												
MS-SS3-1 Mounting bracket for the ultra-small sensor head (The thru-beam type sensor head needs two brackets.) (Note 2)																																	
MS-FX-1 Mounting bracket for SS-A5																																	
CHX-SC2 It is useful for beam alignment of thru-beam type sensors. The optimum receiver position is given by indicators, as well as an audio signal.																																	

Notes: 1) Refer to p.800 for details of the sensor checker **CHX-SC2**.
 2) Refer to p.394 for dimensions of **MS-SS3-1**.

Slit mask

- **OS-SS3**

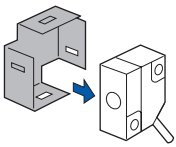

The sensor head and the slit mask are mounted together.

Sensor head mounting bracket

- **MS-SS3-1**

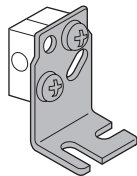

Two M3 (length 12 mm 0.472 in) screws with washers are attached.

Amplifier mounting bracket

- **MS-FX-1**

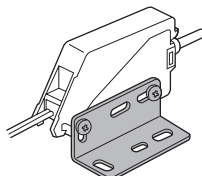

Two M3 (length 20 mm 0.787 in) screws with washers are attached.

Sensor checker

- **CHX-SC2**

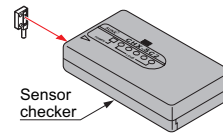

Sensor checker

- FIBER SENSORS
- LASER SENSORS
- PHOTO-ELECTRIC SENSORS
- MICRO PHOTO-ELECTRIC SENSORS
- AREA SENSORS
- SAFETY COMPONENTS
- PRESSURE SENSORS
- INDUCTIVE PROXIMITY SENSORS
- PARTICULAR USE SENSORS
- SENSOR OPTIONS
- WIRE-SAVING SYSTEMS
- MEASUREMENT SENSORS
- STATIC CONTROL DEVICES
- LASER MARKERS
- Selection Guide
- Amplifier Built-in
- CX-400**
- EX-10**
- EX-20**
- EX-30**
- EX-40**
- EQ-30**
- EQ-500**
- MQ-W**
- RX-LS200**
- RX**
- CY**
- PX-2**
- RT-610**
- Power Supply Built-in
- NX5**
- VF**
- Amplifier-separated
- SU-7 / SH**
- SS-A5 / SH**
- Other Products

SPECIFICATIONS

Refer to p.385~ for specifications of sensor head.

Amplifier

Item	Type	Cable type · slim
	Model No.	SS-A5
Applicable sensor heads	SH-2□, SH-3□, SH-72	
Supply voltage	12 to 24 V DC ± 10 % Ripple P-P 10 % or less	
Current consumption	40 mA or less	
Sensing output	NPN open-collector transistor <ul style="list-style-type: none"> • Maximum sink current: 100 mA • Applied voltage: 30 V DC or less (between sensing output and 0 V) • Residual voltage: 1.5 V or less (at 100 mA sink current) 0.4 V or less (at 16 mA sink current) 	
	Output operation	Selectable either Light-ON or Dark-ON with the operation mode switch
	Short-circuit protection	Incorporated
Self-diagnosis output	NPN open-collector transistor <ul style="list-style-type: none"> • Maximum sink current: 50 mA • Applied voltage: 30 V DC or less (between self-diagnosis output and 0 V) • Residual voltage: 1 V or less (at 50 mA sink current) 0.4 V or less (at 16 mA sink current) 	
	Output operation	ON under stable sensing condition
	Short-circuit protection	—
Response time	1 ms or less	
Operation indicator	Red LED (lights up when the sensing output is ON)	
Stability indicator	Green LED (lights up under stable light received condition or stable dark condition)	
Sensitivity adjuster	Continuously variable twin adjusters	
Automatic interference prevention function	Incorporated (Two units of sensors can be mounted close together.)	
Timer function	Approx. 40 ms fixed OFF-delay timer, selectable either effective or ineffective	
Environmental resistance	Ambient temperature	-25 to +60 °C -13 to +140 °F (No dew condensation or icing allowed), Storage: -30 to +70 °C -22 to +158 °F
	Ambient humidity	35 to 85 % RH, Storage: 35 to 85 % RH
	Voltage withstandability	1,000 V AC for one min. between all supply terminals connected together and enclosure
	Insulation resistance	20 MΩ, or more, with 500 V DC megger between all supply terminals connected together and enclosure
	Vibration resistance	10 to 55 Hz frequency, 1.5 mm 0.059 in amplitude in X, Y and Z directions for two hours each
	Shock resistance	100 m/s ² acceleration (10 G approx.) in X, Y and Z directions for three times each
Material	Enclosure: Heat-resistant ABS, Cover: Polyethersulfone	
Cable	0.2 mm ² 4-core cabtyre cable, 3 m 9.843 ft long	
Cable extension	Extension up to total 100 m 328.084 ft is possible with 0.3 mm ² , or more, cable.	
Weight	Net weight: 120 g approx.	
Accessories	MS-DIN-1 (Amplifier mounting bracket): 1pc., Adjusting screwdriver: 1 pc., Adjuster cap: 1 pc.	

Note: Where measurement conditions have not been specified precisely, the conditions used were an ambient temperature of +23 °C **+73.4 °F**.

I/O CIRCUIT AND WIRING DIAGRAMS

I/O circuit diagram

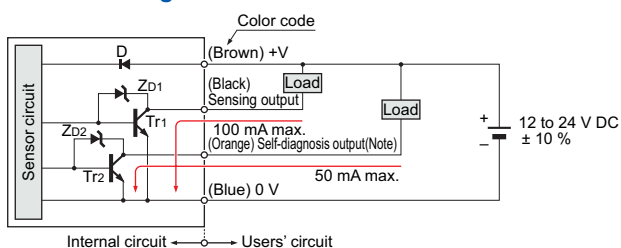

Note: The self-diagnosis output does not incorporate a short-circuit protection circuit. Do not connect it directly to a power supply or a capacitive load.

Symbols ... D: Reverse supply polarity protection diode
ZD1, ZD2: Surge absorption zener diode
Tr1, Tr2 : NPN output transistor

Wiring diagram to sensor head

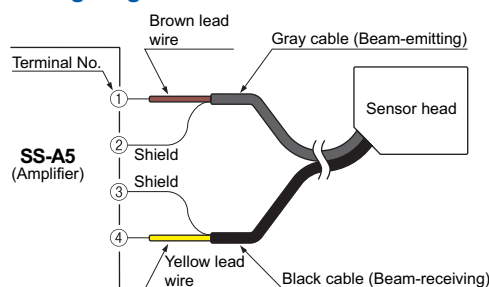

FIBER SENSORS

LASER SENSORS

PHOTO-ELECTRIC SENSORS

MICRO PHOTO-ELECTRIC SENSORS

AREA SENSORS

SAFETY COMPONENTS

PRESSURE SENSORS

INDUCTIVE PROXIMITY SENSORS

PARTICULAR USE SENSORS

SENSOR OPTIONS

WIRE-SAVING SYSTEMS

MEASUREMENT SENSORS

STATIC CONTROL DEVICES

LASER MARKERS

Selection Guide

Amplifier Built-in

CX-400

EX-10

EX-20

EX-30

EX-40

EQ-30

EQ-500

MQ-W

RX-LS200

RX

CY

PX-2

RT-610

Power Supply Built-in

NX5

VF

Amplifier-separated

SU-7 / SH

SS-A5 / SH

Other Products

PRECAUTIONS FOR PROPER USE

Refer to p.986~ for general precautions and p.390 for precautions of sensor head.



- Never use this product as a sensing device for personnel protection.
- In case of using sensing devices for personnel protection, use products which meet laws and standards, such as OSHA, ANSI or IEC etc., for personnel protection applicable in each region or country.

- Always use the sensor head and the exclusive amplifier together as a set.

Cable extension for sensor head

- If the attached sensor head cables need to be extended, use two single core shielded cables of at least equivalent quality. If a joint terminal or connector is used for extension, refer to the figures below.

(The shielded extension cable must be of $\phi 1.45$ mm) $\phi 0.057$ in outer diameter.)

Connection with joint terminal

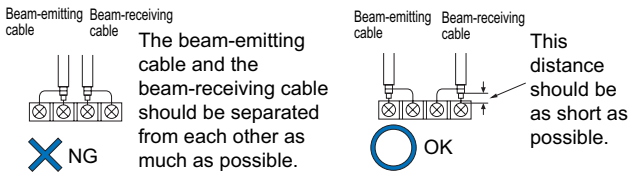

Connection with metal connector

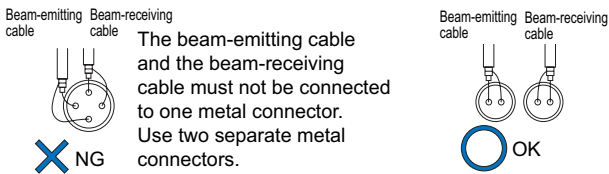

Connection to sensor head

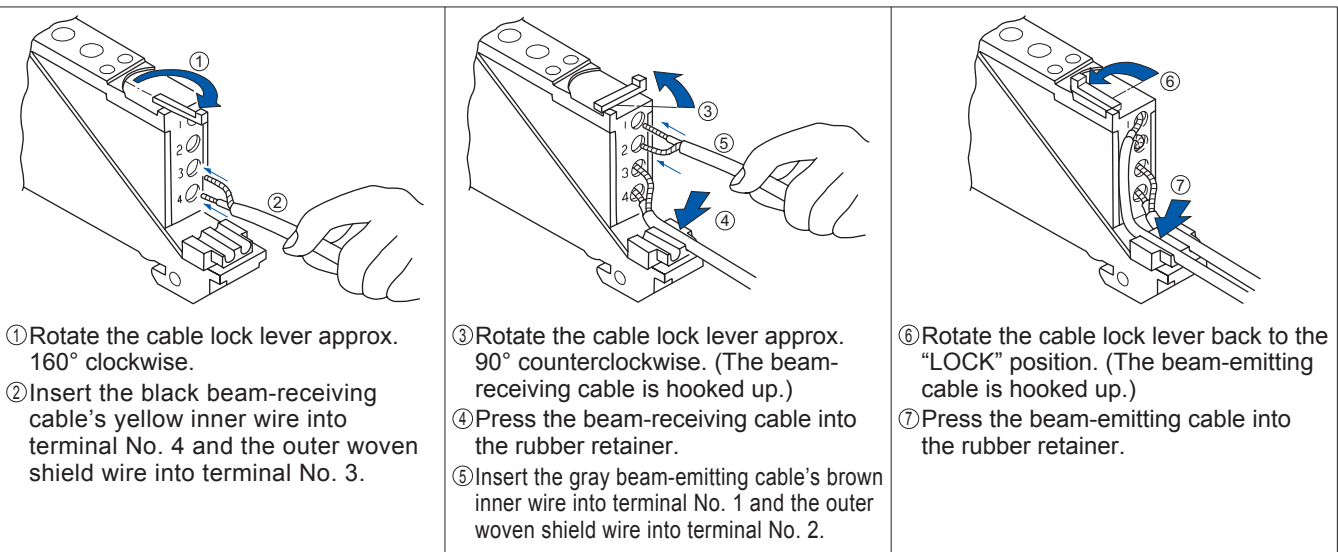

Note: Close the case cover firmly. Not doing so will weaken the shield cable clamp.

Trimming sensor head cables

- Trim the ends of sensor head cables as follows.

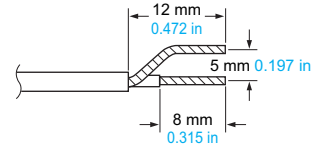

- In case of the reflective type sensor heads, with two parallel cables, the beam-emitting cable must be longer than the beam-receiving cable as shown below.

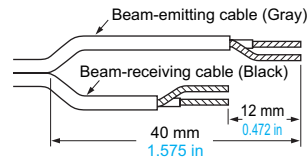

Note: Do not solder the cable ends.

Mounting

- When the amplifier is fixed with screws and nuts, the tightening torque should be 0.58 N·m or less.

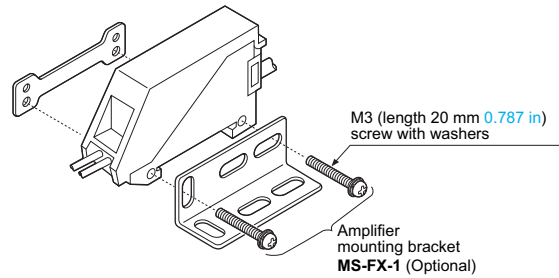

Wiring

- The self-diagnosis output does not incorporate a short-circuit protection circuit. Do not connect it directly to a power supply or a capacitive load.

Others

- Do not use during the initial transient time (30 ms) after the power supply is switched on.

PRECAUTIONS FOR PROPER USE

Refer to p.986~ for general precautions and p.390 for precautions of sensor head.

Self-diagnosis function

- The sensor checks the incident light intensity, and if it is reduced due to dirt or dust, or beam misalignment, an output is generated.

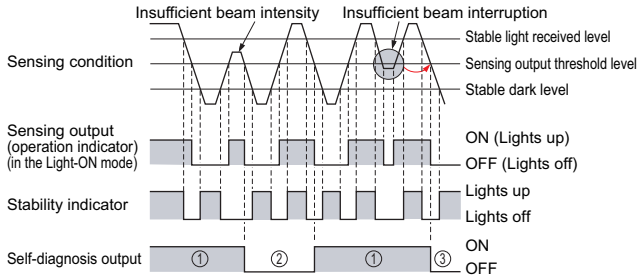

- ① The self-diagnosis output transistor stays in the “ON” state during stable sensing.
- ② When the sensing output changes, if the incident light intensity does not reach the stable light received level or the stable dark level, the self-diagnosis output becomes OFF. Further, the self-diagnosis output changes state when the sensing output changes from Light to Dark state. (It is not affected by the operation mode switch).
- ③ In case of insufficient beam interruption, there will be a time lag before the self-diagnosis output turns OFF.

Timer operation

- If the timer operation mode switch is set to “OFD”, approx. 40 ms fixed OFF-delay timer operation is obtained. This function is useful if the output signal is so short that the connected device cannot respond.

Operation of timer operation mode switch

Timer operation mode switch setting	Sensing mode selection	Sensing condition	Operation
OFD	MODE L. D.	Light-ON normal operation	ON
OFD	MODE L. D.	Light-ON OFF-delay	ON (with T delay)
OFD	MODE L. D.	Dark-ON normal operation	ON
OFD	MODE L. D.	Dark-ON OFF-delay	ON (with T delay)

Timer period: T = 40 ms approx.

DIMENSIONS (Unit: mm in)

The CAD data in the dimensions can be downloaded from the SUNX website: <http://www.sunx.com>
Refer to p.393~ for dimensions of sensor head.

SS-A5 Amplifier

Assembly dimensions with attached amplifier mounting bracket

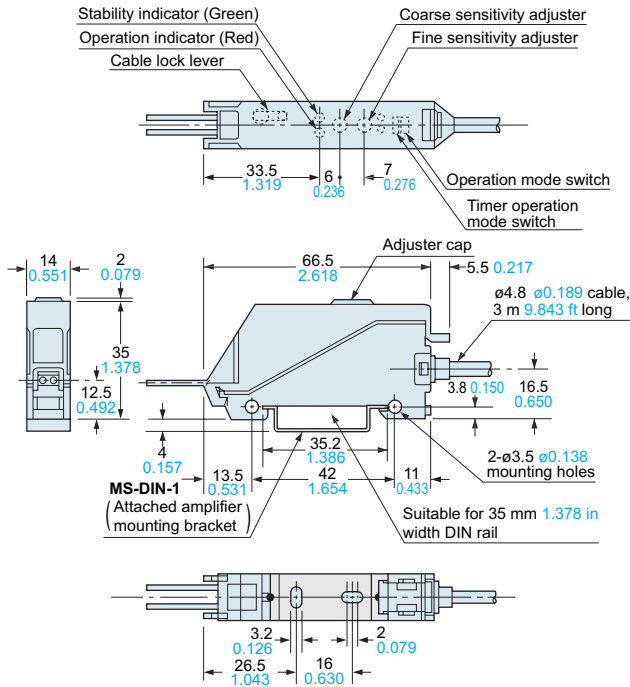

MS-DIN-1 Amplifier mounting bracket (Accessory for Amplifier)

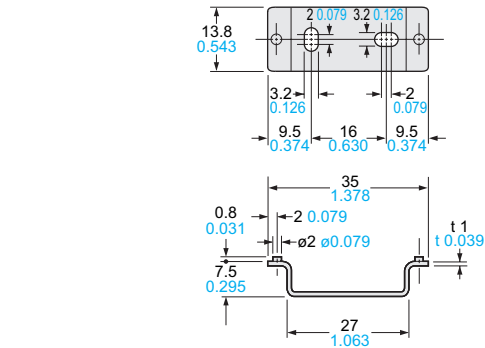

Material: Cold rolled carbon steel (SPCC) (Uni-chrome plated)

MS-FX-1 Amplifier mounting bracket (Optional)

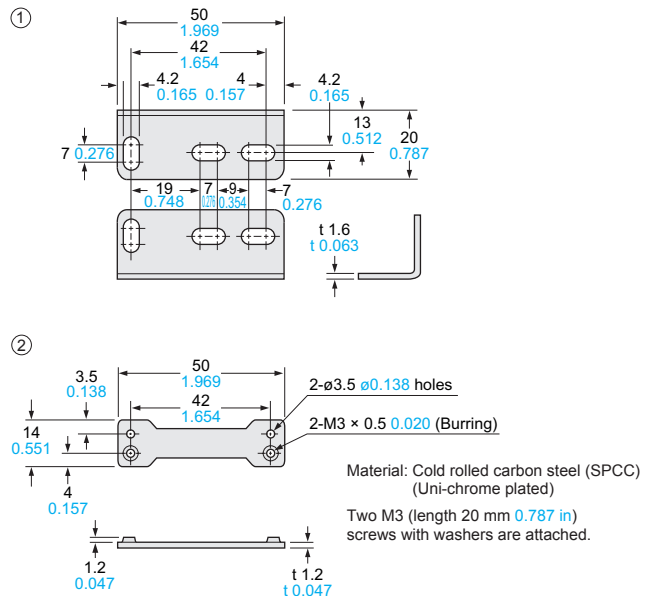

Material: Cold rolled carbon steel (SPCC) (Uni-chrome plated)
Two M3 (length 20 mm 0.787 in) screws with washers are attached.

FIBER SENSORS
LASER SENSORS
PHOTO-ELECTRIC SENSORS
MICRO PHOTO-ELECTRIC SENSORS
AREA SENSORS
SAFETY COMPONENTS
PRESSURE SENSORS
INDUCTIVE PROXIMITY SENSORS
PARTICULAR USE SENSORS
SENSOR OPTIONS
WIRE- SAVING SYSTEMS
MEASURE- MENT SENSORS
STATIC CONTROL DEVICES
LASER MARKERS

Selection Guide
Amplifier Built-in
CX-400
EX-10
EX-20
EX-30
EX-40
EQ-30
EQ-500
MQ-W
RX-LS200
RX
CY
PX-2
RT-610
Power Supply Built-in
NX5
VF
Amplifier-separated
SU-7 / SH
SS-A5 / SH
Other Products