

PROTECTION PRODUCTS - MicroClamp™

Description

The μ Clamp™ series of Transient Voltage Suppressors (TVS) are designed to replace multilayer varistors (MLVs) in portable applications where low operating voltage is vital. They offer superior electrical characteristics such as lower clamping voltage and no device degradation when compared to MLVs. They are designed to protect sensitive semiconductor components from damage or upset due to electrostatic discharge (ESD), lightning, electrical fast transients (EFT), and cable discharge events (CDE).

The μ Clamp™3311P is constructed using Semtech's proprietary EPD process technology. The EPD process provides low standoff voltages with significant reductions in leakage currents and capacitance over silicon-avalanche diode processes. They feature a true operating voltage of 3.3 volts for superior protection when compared to traditional pn junction devices.

The μ Clamp™3311P is in an 2-pin, RoHS/WEEE compliant, SLP1006P2 package. It measures 1.0 x 0.6 x 0.5mm. The leads are spaced at a pitch of 0.65mm and are finished with lead-free NiPdAu. Each device will protect one line operating at 3.3 volts. It gives the designer the flexibility to protect single lines in applications where arrays are not practical. They may be used to meet the ESD immunity requirements of IEC 61000-4-2, Level 4 (± 15 kV air, ± 8 kV contact discharge). The combination of small size and high ESD surge capability makes them ideal for use in portable applications such as cellular phones, digital cameras, and MP3 players.

Features

- ◆ Transient protection for data lines to **IEC 61000-4-2 (ESD) ± 15 kV (air), ± 8 kV (contact)**
IEC 61000-4-4 (EFT) 40A (tp = 5/50ns)
Cable Discharge Event (CDE)
- ◆ Ultra-small package (1.0 x 0.6 x 0.5mm)
- ◆ Protects one data line
- ◆ Low clamping voltage
- ◆ Working voltage: 3.3V
- ◆ Low leakage current
- ◆ Solid-state silicon-avalanche technology

Mechanical Characteristics

- ◆ SLP1006P2 package
- ◆ RoHS/WEEE Compliant
- ◆ Nominal Dimensions: 1.0 x 0.6 x 0.5 mm
- ◆ Lead Finish: NiPdAu
- ◆ Molding compound flammability rating: UL 94V-0
- ◆ Marking : Marking code, cathode band
- ◆ Packaging : Tape and Reel

Applications

- ◆ Cellular Handsets & Accessories
- ◆ Notebooks & Handhelds
- ◆ Portable Instrumentation
- ◆ Digital Cameras
- ◆ Peripherals
- ◆ MP3 Players

Dimensions

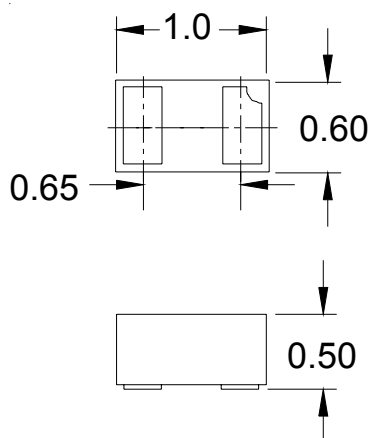

Maximum Dimensions (mm)

Schematic & PIN Configuration

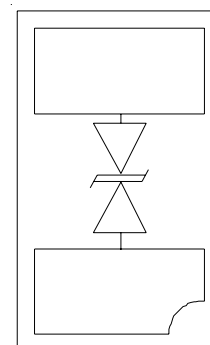

SLP1006P2 (Bottom View)

PROTECTION PRODUCTS
Absolute Maximum Rating

Rating	Symbol	Value	Units
Peak Pulse Power (tp = 8/20μs)	P_{pk}	90	Watts
Maximum Peak Pulse Current (tp = 8/20μs)	I_{pp}	5	Amps
ESD per IEC 61000-4-2 (Air) ESD per IEC 61000-4-2 (Contact)	V_{ESD}	+/- 25 +/- 20	kV
Operating Temperature	T_J	-40 to +85	°C
Storage Temperature	T_{STG}	-55 to +150	°C

Electrical Characteristics (T=25°C)

Parameter	Symbol	Conditions	Minimum	Typical	Maximum	Units
Reverse Stand-Off Voltage	V_{RWM}				3.3	V
Punch-Through Voltage	V_{PT}	$I_{PT} = 2\mu A$	3.5			V
Snap-Back Voltage	V_{SB}	$I_{SB} = 50mA$	2.8			V
Reverse Leakage Current	I_R	$V_{RWM} = 3.3V$		0.05	0.5	μA
Clamping Voltage	V_C	$I_{pp} = 1A, tp = 8/20\mu s$			8	V
Clamping Voltage	V_C	$I_{pp} = 5A, tp = 8/20\mu s$			18	V
Junction Capacitance	C_j	I/O pin to Gnd $V_R = 0V, f = 1MHz$		12	15	pF
		I/O pin to Gnd $V_R = 3.3V, f = 1MHz$		10		pF

PROTECTION PRODUCTS

Typical Characteristics

Non-Repetitive Peak Pulse Power vs. Pulse Time

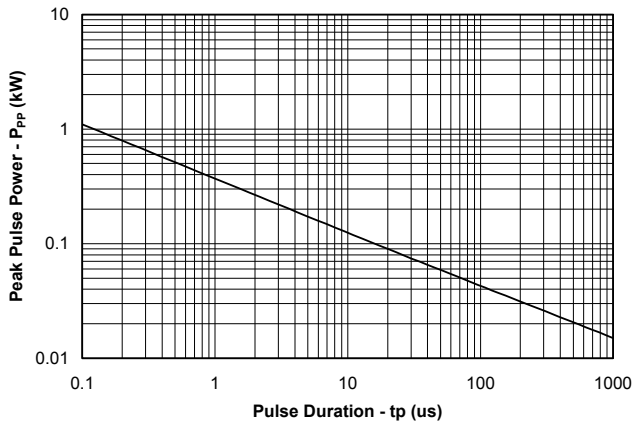

Power Derating Curve

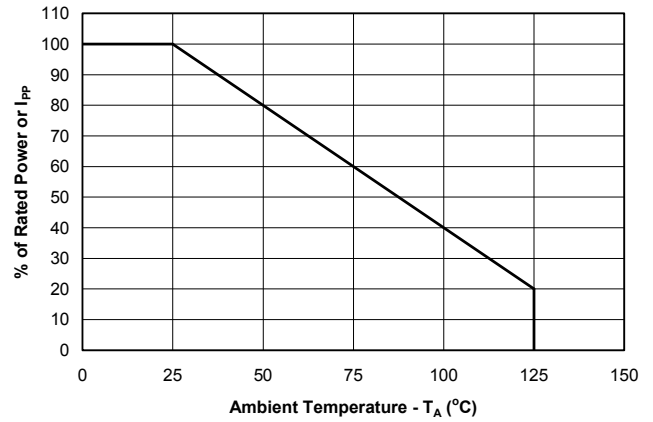

Clamping Voltage vs. Peak Pulse Current

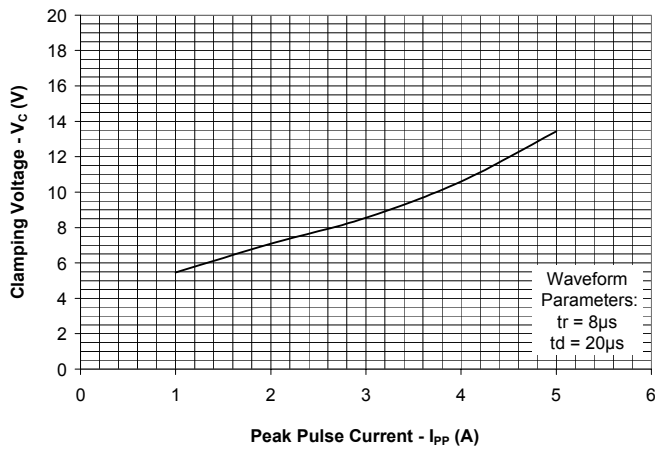

Normalized Capacitance vs. Reverse Voltage

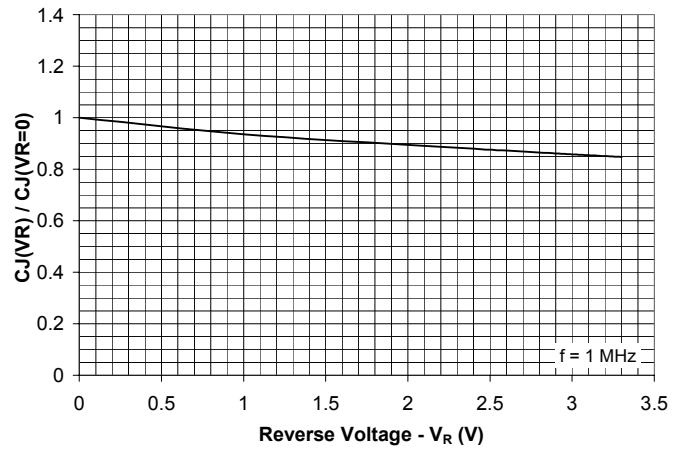

Insertion Loss S21

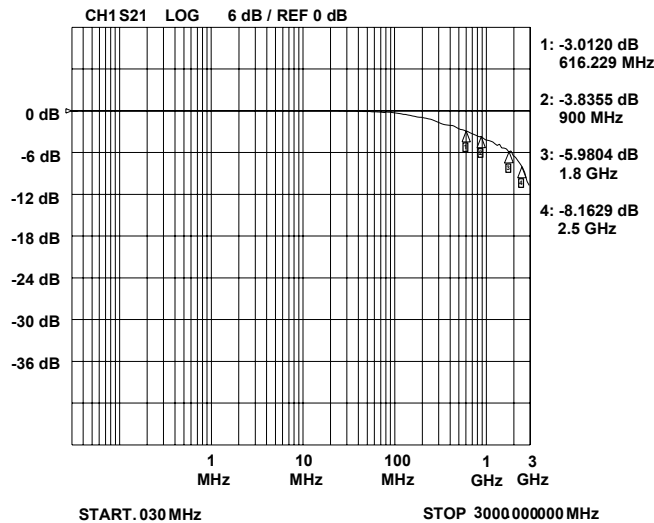

PROTECTION PRODUCTS

Applications Information

Device Connection Options

The μ Clamp3311P is designed to protect one data line operating up to 3.3 volts. It will present a high impedance to the protected line up to 3.3 volts. It will “turn on” when the line voltage exceeds 3.5 volts. The device is bidirectional and may be used on lines where the signal polarity is above and below ground. These devices are not recommended for use on dc power supply lines due to their snap-back voltage characteristic.

EPD TVS Characteristics

These devices are constructed using Semtech’s proprietary EPD technology. The structure of the EPD TVS is vastly different from the traditional pn-junction devices. At voltages below 5V, high leakage current and junction capacitance render conventional avalanche technology impractical for most applications. However, by utilizing the EPD technology, these devices can effectively operate at 3.3V while maintaining excellent electrical characteristics.

The EPD TVS employs a complex nppn structure in contrast to the pn structure normally found in traditional silicon-avalanche TVS diodes. The EPD mechanism is achieved by engineering the center region of the device such that the reverse biased junction does not avalanche, but will “punch-through” to a conducting state. This structure results in a device with superior DC electrical parameters at low voltages while maintaining the capability to absorb high transient currents.

Circuit Board Layout Recommendations for Suppression of ESD.

Good circuit board layout is critical for the suppression of ESD induced transients. The following guidelines are recommended:

- Place the TVS near the input terminals or connectors to restrict transient coupling.
- Minimize the path length between the TVS and the protected line.
- Minimize all conductive loops including power and ground loops.
- The ESD transient return path to ground should be kept as short as possible.
- Never run critical signals near board edges.
- Use ground planes whenever possible.

Device Schematic & Pin Configuration

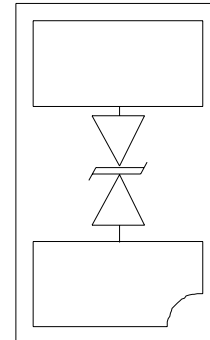

EPD TVS IV Characteristic Curve

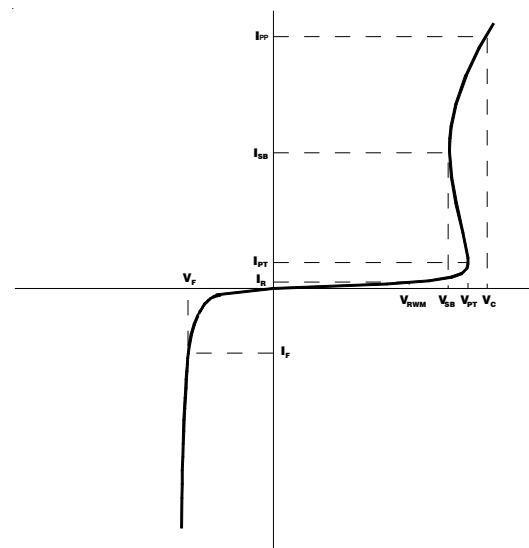

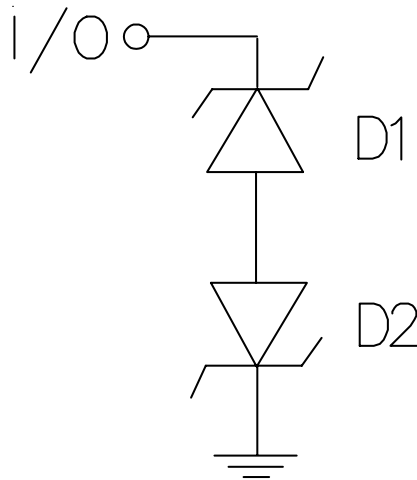
PROTECTION PRODUCTS
Applications Information - Spice Model

uClamp3311P Spice Model

uClamp3311P Spice Parameters			
Parameter	Unit	D1 (TVS)	D2 (TVS)
IS	Amp	1E-20	1E-20
BV	Volt	3.8	3.8
VJ	Volt	0.7	0.7
RS	Ohm	1.1	1.1
IBV	Amp	1E-3	1E-3
CJO	Farad	20E-12	20E-12
TT	sec	2.541E-9	2.541E-9
M	--	0.214	0.214
N	--	1.1	1.1
EG	eV	1.11	1.11

PROTECTION PRODUCTS

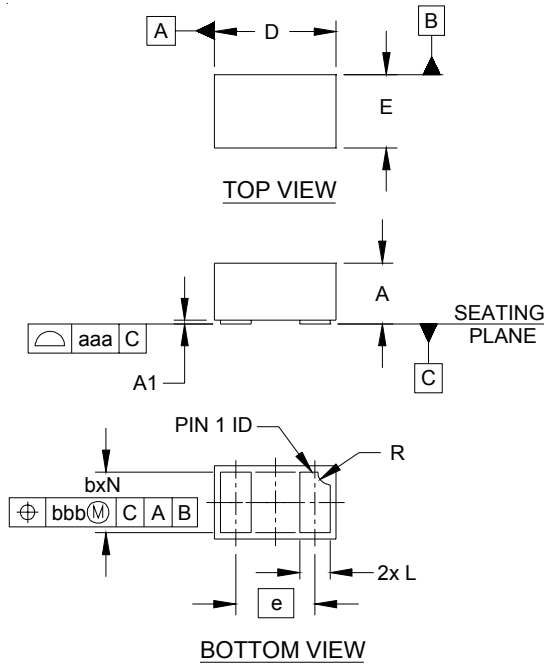
Outline Drawing - SLP1006P2



DIM	INCHES			MILLIMETERS		
	MIN	NOM	MAX	MIN	NOM	MAX
A	.016	.020	.022	0.40	0.50	0.55
A1	.000	.001	.002	0.00	0.03	0.05
b	.018	.020	.022	0.45	0.50	0.55
D	.035	.039	.043	0.90	1.00	1.10
E	.020	.024	.028	0.50	0.60	0.70
e	.026 BSC			0.65 BSC		
L	.008	.010	.012	0.20	0.25	0.30
R	.002	.004	.006	0.05	0.10	0.15
N	2			2		
aaa	.003			0.08		
bbb	.004			0.10		

NOTES:

1. CONTROLLING DIMENSIONS ARE IN MILLIMETERS (ANGLES IN DEGREES).

Land Pattern - SLP1006P2

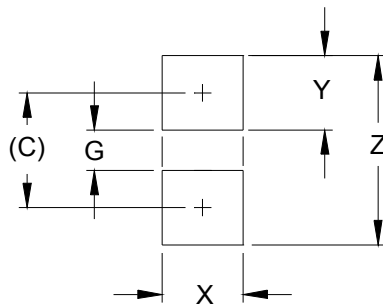

DIM	DIMENSIONS	
	INCHES	MILLIMETERS
C	(.033)	(0.85)
G	.012	0.30
X	.024	0.60
Y	.022	0.55
Z	.055	1.40

NOTES:

1. CONTROLLING DIMENSIONS ARE IN MILLIMETERS (ANGLES IN DEGREES).
2. THIS LAND PATTERN IS FOR REFERENCE PURPOSES ONLY. CONSULT YOUR MANUFACTURING GROUP TO ENSURE YOUR COMPANY'S MANUFACTURING GUIDELINES ARE MET.

PROTECTION PRODUCTS

Marking Code

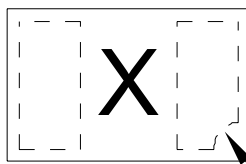

PIN 1 ID

Ordering Information

Part Number	Working Voltage	Qty per Reel	Reel Size
uClamp3311P.TCT	3.3V	3,000	7 Inch

Notes:

1) This is a lead-free, RoHS/WEEE compliant product
MicroClamp, uClamp and μ Clamp are marks of Semtech Corporation

Tape and Reel Specification

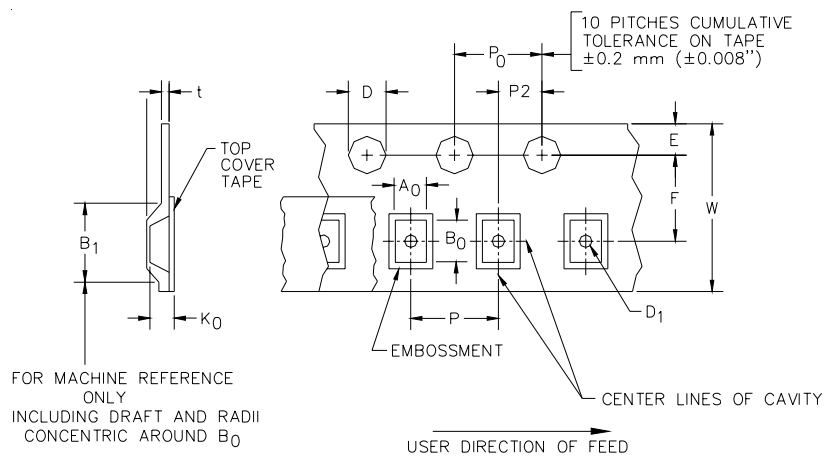

A0	B0	K0
0.69 +/-0.10 mm	1.19 +/-0.10 mm	0.66 +/-0.10 mm

Tape Width	B, (Max)	D	D1	E	F	P	P0	P2	T	W
8 mm	4.2 mm (.165)	1.5 + 0.1 mm - 0.0 mm (0.59 +.005 -.000)	0.4 mm ± 0.25 (.031)	1.750 \pm .10 mm (.069 \pm .004)	3.5 \pm 0.05 mm (.138 \pm .002)	4.0 \pm 0.10 mm (.157 \pm .004)	4.0 \pm 0.1 mm (.157 \pm .004)	2.0 \pm 0.05 mm (.079 \pm .002)	0.254 \pm 0.02 mm (.016)	8.0 mm + 0.3 mm - 0.1 mm (.312 \pm .012)

Contact Information

Semtech Corporation
Protection Products Division
200 Flynn Road, Camarillo, CA 93012
Phone: (805)498-2111 FAX (805)498-3804