

Pb THIS PRODUCT MANUFACTURED
WITH LEAD-FREE PROCESSING

DO NOT
SCALE FROM
THIS PRINT

CABLE CALLOUT
179: RG179 CABLE (CCA-179)

OVERALL ASSEMBLY LENGTH (OAL)
XXXX (MILLIMETERS) (0100 MIN)
(SEE NOTE 8)

END 1 CONNECTOR
(SEE TABLE 3, SHEET 2)

END 2 CONNECTOR OR PREPARATION
(SEE TABLE 3, SHEET 2)

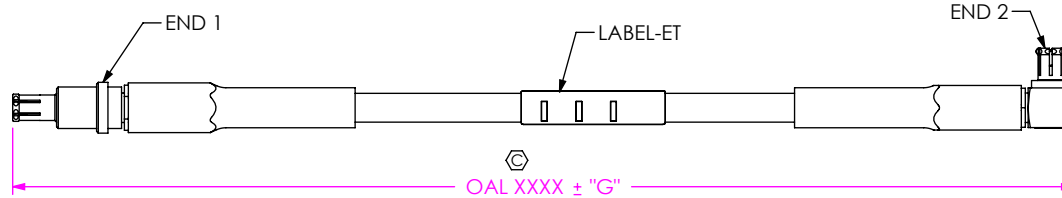

FIG 1
RF179-73SPX-73RPX-XXXX SHOWN

TABLE 2	
OVERALL LENGTH	"G"
0100-0200 [3.92-7.87]	+3.0 [.12]/-0.0 [.00]
0200-0500 [7.87-19.69]	+5.0 [.20]/-0.0 [.00]
0500-1000 [19.69-39.37]	+10.0 [.40]/-0.0 [.00]

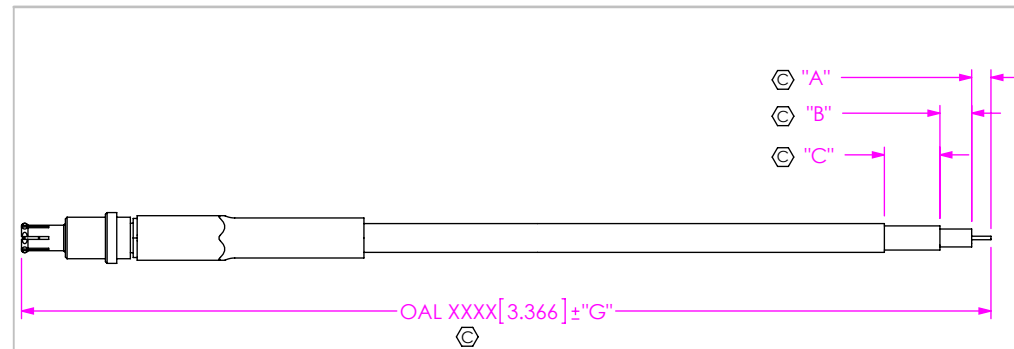

FIG 2
RF179-73SPX-172849-XXXX SHOWN (SEE NOTE 5 & 7)

"C" (FORMAT: X.X)
"B" (FORMAT: X.X)
"A" (FORMAT: X.X)

DO NOT LEAVE ANY SPACE BLANK,
EACH MUST CONTAIN A
NUMERIC CHARACTER 0 THRU 9.

NOTES:

- ⑥ REPRESENTS A CRITICAL DIMENSION
- ASSEMBLY TO BE 100% TESTED FOR OPENS, SHORTS & HI-POT TESTED (PER TABLE 3, AC OR DC), THE HI-POST VOLTAGE FOR THE ASSEMBLY SHOULD BE SET TO THE END OPTION WITH THE LOWEST TEST VOLTAGE RATING.
- AFTER FINAL ELECTRICAL TEST, LABEL EACH CABLE ASSEMBLY WITH 1 LABEL-ET
- CABLE ASSEMBLIES TO BE BULK BAGS. LOCK WASHERS, NUTS, AND/OR GASKETS ARE NOT TO BE ASSEMBLED AND PACKAGED IN SEPARATE BULK BAGS.
- DIM "A", "B", AND "C" HAVE A MINIMUM VALUE OF 0.0mm & A MAXIMUM VALUE OF 9.9mm
- CONNECTORS TO BE ORIENTED ACCORDING TO CO-RF-WI-3048-M.
- FOR STRIPPED AND TINNED OPTION, ONLY THE CENTER CONDUCTOR IS TINNED.
- CABLE LENGTHS LONGER THAN 1000 MILLIMETERS ARE NOT SUPPORTED BY S.I. TEST DATA.

UNLESS OTHERWISE SPECIFIED,
DIMENSIONS ARE IN
MILLIMETERS [INCHES].
TOLERANCES ARE:
DECIMALS ANGLES
.X: ±0.3 [.01] 2°
.XX: ±0.13 [.005]
.XXX: ±0.051 [.0020]

PROPRIETARY NOTE
THIS DOCUMENT CONTAINS CONFIDENTIAL AND
PROPRIETARY INFORMATION AND ALL DESIGN,
MANUFACTURING, REPRODUCTION, USE, PATENT RIGHTS
AND SALES RIGHTS ARE EXPRESSLY RESERVED BY SAMTEC,
INC. THIS DOCUMENT SHALL NOT BE DISCLOSED, IN WHOLE
OR PART, TO ANY UNAUTHORIZED PERSON OR ENTITY NOR
REPRODUCED, TRANSFERRED OR INCORPORATED IN ANY
OTHER PROJECT IN ANY MANNER WITHOUT THE EXPRESS
WRITTEN CONSENT OF SAMTEC, INC.

MATERIAL: DO NOT SCALE DRAWING SHEET SCALE: 2:1
SHELLS, CONTACTS, FERRULES: BRASS
DIELECTRIC: PTFE
GASKETS: SILICONE
D45PX SHELL: ZINC



520 PARK EAST BLVD. NEW ALBANY, IN 47150
PHONE: 812-944-6733 FAX: 812-948-5047
e-Mail: info@SAMTEC.com code 55322

DESCRIPTION: RF179 CABLE ASSEMBLY
DWG. NO. RF179-XXXXX-XXXXXX-XXXX
BY: B. RAY 1-30-2007 SHEET 1 OF 10

TABLE 1

END OPTION	SUBTRACTOR	STRIP DIMENSIONS			HI POT	
		"Y"	"A"	"D"	"E"	"DC"
-74BJ3	13.4 [0.53]	4.6 [0.18]	8.2 [0.32]	17.9 [0.70]	1000	1200
-74BJ2						
-74SP3	10.3 [0.41]	3.2 [0.13]	5.4 [0.21]	12.1 [0.48]	1000	1200
-D4SP3						
-78SP4	15.7 [0.62]	2.6 [0.10]	5.0 [0.20]	12.3 [0.48]	1000	250
-78SP5						
-78SP6						
-78SP8						
-72RP1						
-72RP2	2.0 [0.08]	1.0 [0.04]	3.1 [0.12]	7.9 [0.31]	1000	500
-72SP1						
-72SP2	7.3 [0.29]	2.0 [0.08]	3.3 [0.13]	8.6 [0.34]	1000	500
** -79RP3						
** -79RP2	5.3 [0.21]	1.1 [0.04]	6.8 [0.27]	13.3 [0.52]	1000	500
** -79SP3						
** -79SP2	8.7 [0.34]	2.5 [0.10]	4.9 [0.19]	10.7 [0.42]	1000	500
-73SJ4						
-73SJ1	4.7 [0.19]	1.7 [0.07]	4.5 [0.18]	9.4 [0.37]	1000	250
-73RP4						
-73RP1	1.7 [0.07]	1.7 [0.07]	3.0 [0.12]	8.0 [0.31]	1000	250
-73SP4						
-73SP1	5.5 [0.22]	1.7 [0.07]	4.5 [0.18]	9.4 [0.37]	1000	250
-77RP1						
-77RP2	2.9 [0.11]	1.9 [0.07]	4.9 [0.19]	10.1 [0.40]	1000	1000
-77SP1						
-77SP2	7.5 [0.30]	2.0 [0.08]	4.2 [0.17]	9.5 [0.37]	1000	1000
*-SING						
*-XXXXX	0.0 [0.00]	-	-	-	1000	N/A
*-XXXXX	0.0 [0.00]	"A"	"A"+"B"	"A"+"B"+"C"	1000	N/A

* = END 2 OPTION ONLY
 ** - FOR EXISTING CUSTOMERS ONLY

TABLE 3

END OPTION	SERIES	GENDER	CONFIGURATION	PLATING			FIGURE
				CENTER CONTACT	OUTER CONTACT	OTHER COMPONENTS	
-74BJ3	BNC	JACK	STRAIGHT BULKHEAD	10u" GOLD	100u" NICKEL	100u" NICKEL	SHT 3, FIG 3
-74BJ2	BNC	JACK	STRAIGHT BULKHEAD	30u" GOLD	100u" NICKEL	100u" NICKEL	
-74SP3	BNC	PLUG	STRAIGHT	10u" GOLD	100u" NICKEL	100u" NICKEL	SHT 3, FIG 4
-D4SP3	BNC	PLUG	STRAIGHT DIE CAST	10u" GOLD	100u" NICKEL	100u" NICKEL	
-78SP4	DIN 1.0 / 2.3	PLUG	STRAIGHT	10u" GOLD	3u" GOLD	100u" NICKEL	SHT 4, FIG 5
-78SP5	DIN 1.0 / 2.3	PLUG	STRAIGHT	10u" GOLD	10u" GOLD	100u" NICKEL	
-78SP6	DIN 1.0 / 2.3	PLUG	STRAIGHT	30u" GOLD	30u" GOLD	100u" NICKEL	
-78SP8	DIN 1.0 / 2.3	PLUG	STRAIGHT	30u" GOLD	3u" GOLD	100u" NICKEL	
-72RP1	MCX	PLUG	RIGHT ANGLE	30u" GOLD	3u" GOLD	3u" GOLD	
-72RP2	MCX	PLUG	RIGHT ANGLE	30u" GOLD	3u" GOLD	100u" NICKEL	SHT 4, FIG 6
-72SP1	MCX	PLUG	STRAIGHT	30u" GOLD	3u" GOLD	3u" GOLD	
-72SP2	MCX	PLUG	STRAIGHT	30u" GOLD	3u" GOLD	100u" NICKEL	SHT 5, FIG 7
** -79RP3	MINI BNC	PLUG	RIGHT ANGLE	10u" GOLD	100u" NICKEL	100u" NICKEL	
** -79RP2	MINI BNC	PLUG	RIGHT ANGLE	30u" GOLD	100u" NICKEL	100u" NICKEL	SHT 5, FIG 8
** -79SP3	MINI BNC	PLUG	STRAIGHT	10u" GOLD	100u" NICKEL	100u" NICKEL	
** -79SP2	MINI BNC	PLUG	STRAIGHT	30u" GOLD	100u" NICKEL	100u" NICKEL	SHT 6, FIG 9
-73SJ4	MMCX	JACK	STRAIGHT	10u" GOLD	3u" GOLD	100u" NICKEL	
-73SJ1	MMCX	JACK	STRAIGHT	30u" GOLD	3u" GOLD	3u" GOLD	SHT 6, FIG 10
-73RP4	MMCX	PLUG	RIGHT ANGLE	10u" GOLD	3u" GOLD	100u" NICKEL	
-73RP1	MMCX	PLUG	RIGHT ANGLE	30u" GOLD	3u" GOLD	3u" GOLD	SHT 7, FIG 11
-73SP4	MMCX	PLUG	STRAIGHT	10u" GOLD	3u" GOLD	100u" NICKEL	
-73SP1	MMCX	PLUG	STRAIGHT	30u" GOLD	3u" GOLD	3u" GOLD	SHT 7, FIG 12
-77RP1	SMB	PLUG	RIGHT ANGLE	30u" GOLD	3u" GOLD	3u" GOLD	
-77RP2	SMB	PLUG	RIGHT ANGLE	30u" GOLD	3u" GOLD	100u" NICKEL	SHT 8, FIG 13
-77SP1	SMB	PLUG	STRAIGHT	30u" GOLD	3u" GOLD	3u" GOLD	
-77SP2	SMB	PLUG	STRAIGHT	30u" GOLD	3u" GOLD	100u" NICKEL	SHT 8, FIG 14
*-SING	SINGLE ENDED	-	-	-	-	-	
*-XXXXX	STRIPPED & TINNED	-	-	-	-	-	SHT 1, FIG 2

* = END 2 OPTION ONLY
 ** - FOR EXISTING CUSTOMERS ONLY

PROPRIETARY NOTE

THIS DOCUMENT CONTAINS CONFIDENTIAL AND PROPRIETARY INFORMATION AND ALL DESIGN, MANUFACTURING, REPRODUCTION, USE, PATENT RIGHTS AND SALES RIGHTS ARE EXPRESSLY RESERVED BY SAMTEC, INC. THIS DOCUMENT SHALL NOT BE DISCLOSED, IN WHOLE OR PART, TO ANY UNAUTHORIZED PERSON OR ENTITY NOR REPRODUCED, TRANSFERRED OR INCORPORATED IN ANY OTHER PROJECT IN ANY MANNER WITHOUT THE EXPRESS WRITTEN CONSENT OF SAMTEC, INC.

DO NOT SCALE DRAWING

SHEET SCALE: 2:1



520 PARK EAST BLVD, NEW ALBANY, IN 47150
 PHONE: 812-944-6733 FAX: 812-948-5047
 e-Mail info@SAMTEC.com code 55322

DESCRIPTION:
 RF179 CABLE ASSEMBLY

DWG. NO.
RF179-XXXXX-XXXXXX-XXXX

BY: B. RAY 1-30-2007 SHEET 2 OF 10

FIG 3
-74BJX SHOWN

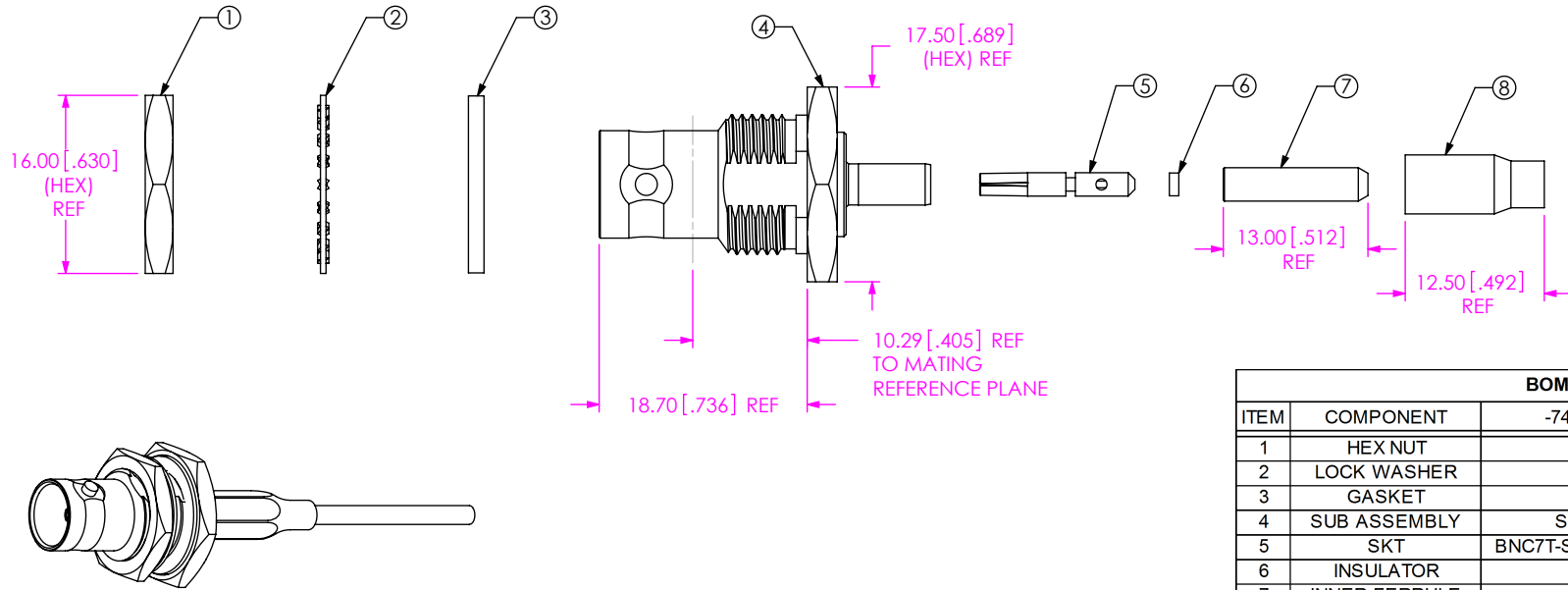

BOM			
ITEM	COMPONENT	-74BJ2	-74BJ3
1	HEX NUT	BTNC-NUT-001-N	
2	LOCK WASHER	BTNC-LWAS-001-N	
3	GASKET	BTNC-GKT-001	
4	SUB ASSEMBLY	SUB-BNC7T-J-C-N-ST-BH3	
5	SKT	BNC7T-SKT-003-H	BNC7T-SKT-003-G
6	INSULATOR	BNC7-INS-001	
7	INNER FERRULE	BTNC-FER-001-N	
8	OUTER FERRULE	BNC-FER-002-N	

FIG 4
-74SPX / D4SPX SHOWN

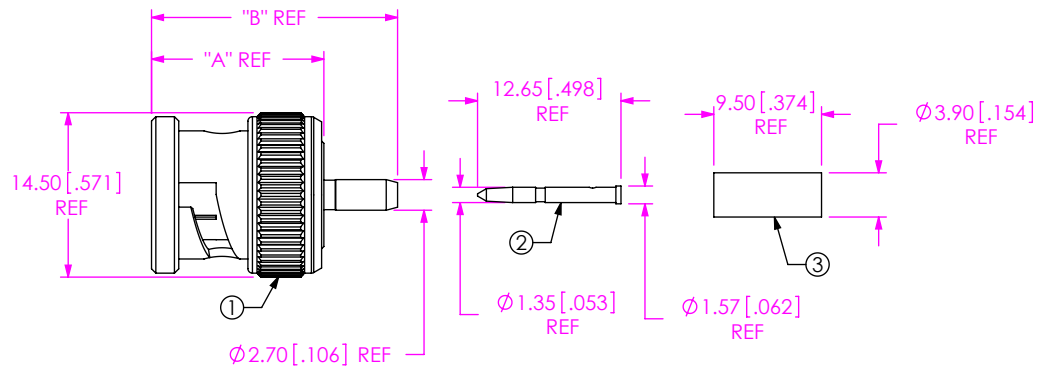

BOM 1		
ITEM	COMPONENT	-74SP3 / D4SP3
1	SUB ASSEMBLY	SUB-BNC7T-P-C-N-ST-CA3X (SEE BOM 2)
2	PIN	BNC7T-P-C-G-ST-CA3-PIN
3	FERRULE	SMA-FER-001-N

BOM 2			
OPTION	SUB ASSEMBLY	"A"	"B"
-74SP3	SUB-BNC7T-P-C-N-ST-CA3	15.20 [0.598]	21.70 [0.854]
-D4SP3	SUB-BNC7T-P-C-N-ST-CA3D	15.12 [0.595]	21.62 [0.851]

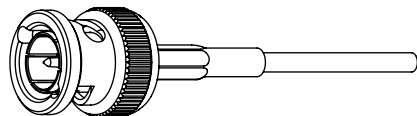

PROPRIETARY NOTE
THIS DOCUMENT CONTAINS CONFIDENTIAL AND PROPRIETARY INFORMATION AND ALL DESIGN, MANUFACTURING, REPRODUCTION, USE, PATENT RIGHTS AND SALES RIGHTS ARE EXPRESSLY RESERVED BY SAMTEC, INC. THIS DOCUMENT SHALL NOT BE DISCLOSED, IN WHOLE OR PART, TO ANY UNAUTHORIZED PERSON OR ENTITY NOR REPRODUCED, TRANSFERRED OR INCORPORATED IN ANY OTHER PROJECT IN ANY MANNER WITHOUT THE EXPRESS WRITTEN CONSENT OF SAMTEC, INC.

DO NOT SCALE DRAWING

SHEET SCALE: 3:2

samtec

520 PARK EAST BLVD, NEW ALBANY, IN 47150
PHONE: 812-944-6733 FAX: 812-948-5047
e-Mail info@SAMTEC.com code 55322

DESCRIPTION:
RF179 CABLE ASSEMBLY

DWG. NO.
RF179-XXXXX-XXXXXX-XXXX

BY: B. RAY 1-30-2007 SHEET 3 OF 10

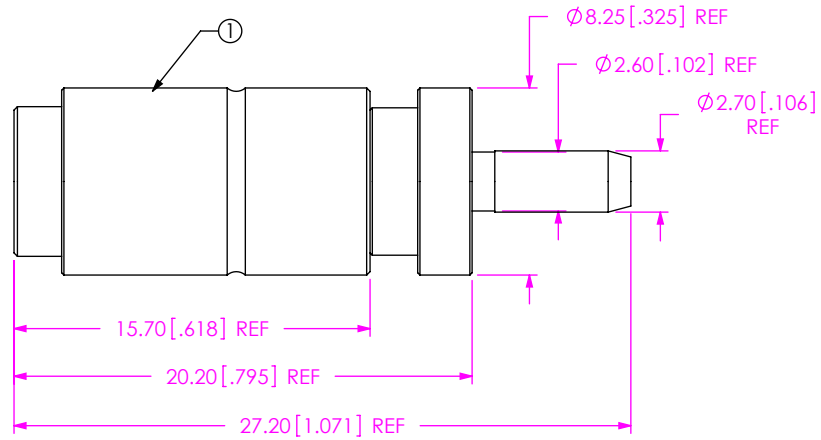
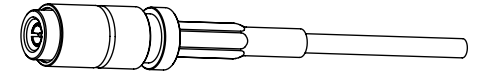
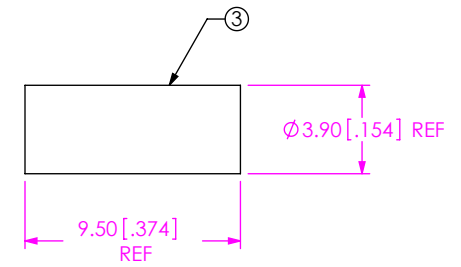
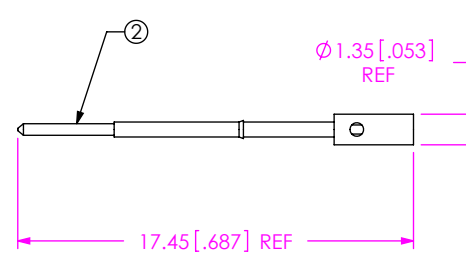
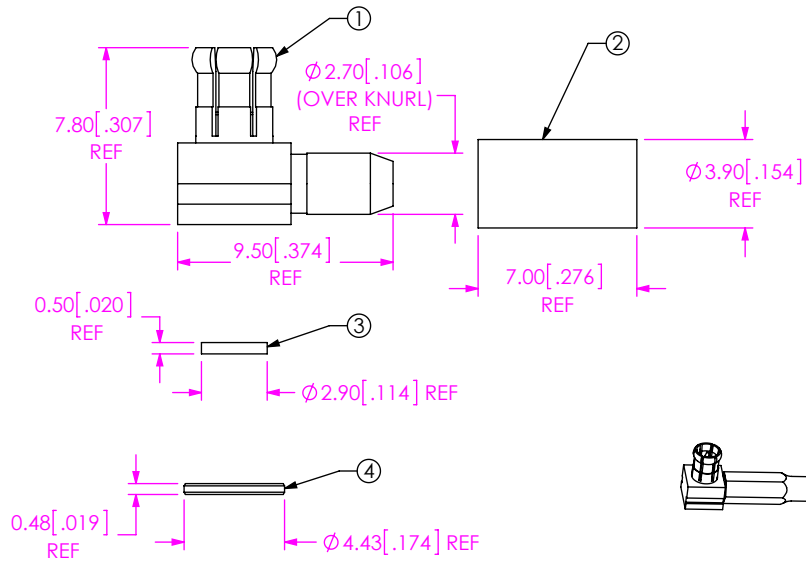

FIG 5
-78SPX SHOWN



BOM					
ITEM	COMPONENT	-78SP4	-78SP5	-78SP6	-78SP8
1	SUB ASSEMBLY	SUB-DIN7A-PP-C-FN-ST-CA3	SUB-DIN7A-PP-C-GN-ST-CA3	SUB-DIN7A-PP-C-HN-ST-CA3	SUB-DIN7A-PP-C-FN-ST-CA3
2	PIN	DIN7A-P-C-G-ST-CA3-PIN			
3	FERRULE	SMA-FER-001-N			

FIG 6
-72RPX SHOWN



BOM			
ITEM	COMPONENT	-72RP1	-72RP2
1	SUB ASSEMBLY	SUB-MCX7-P-C-H-RA-CA3	SUB-MCX7-P-C-HN-RA-CA3
2	FERRULE	MCX-FER-001-F	MCX-FER-001-N
3	INSULATOR	MCX-INS-001	
4	CAP	MCX-CAP-001-F	MCX-CAP-001-N

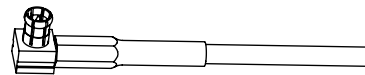

PROPRIETARY NOTE
 THIS DOCUMENT CONTAINS CONFIDENTIAL AND PROPRIETARY INFORMATION AND ALL DESIGN, MANUFACTURING, REPRODUCTION, USE, PATENT RIGHTS AND SALES RIGHTS ARE EXPRESSLY RESERVED BY SAMTEC, INC. THIS DOCUMENT SHALL NOT BE DISCLOSED, IN WHOLE OR PART, TO ANY UNAUTHORIZED PERSON OR ENTITY NOR REPRODUCED, TRANSFERRED OR INCORPORATED IN ANY OTHER PROJECT IN ANY MANNER WITHOUT THE EXPRESS WRITTEN CONSENT OF SAMTEC, INC.

DO NOT SCALE DRAWING

SHEET SCALE: 3:1



520 PARK EAST BLVD. NEW ALBANY, IN 47150
 PHONE: 812-944-6733 FAX: 812-948-5047
 e-Mail info@SAMTEC.com code 55322

DESCRIPTION:
 RF179 CABLE ASSEMBLY
 DWG. NO.
RF179-XXXXX-XXXXXX-XXXX
 BY: B. RAY 1-30-2007 SHEET 4 OF 10

FIG 7
-72SPX SHOWN

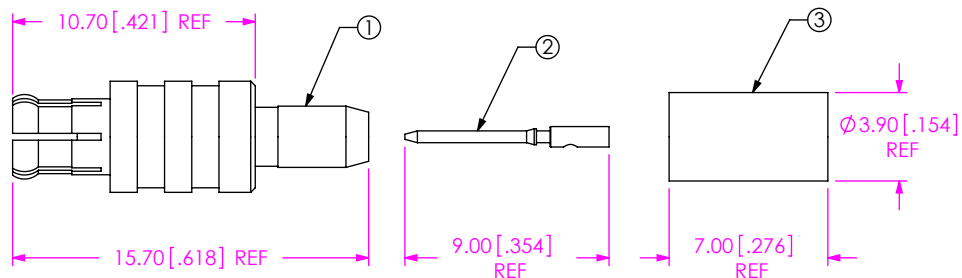

BOM			
ITEM	COMPONENT	-72SP1	-72SP2
1	SUB ASSEMBLY	SUB-MCX7-P-C-F-ST-CA3	SUB-MCX7-P-C-FN-ST-CA3
2	PIN	MCX7-P-C-H-ST-CA3-PIN	
3	OUTER FERRULE	MCX-FER-001-F	MCX-FER-001-N

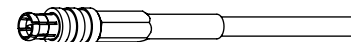
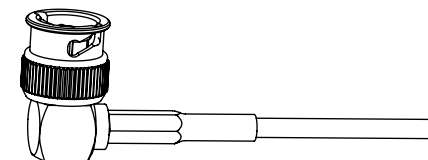
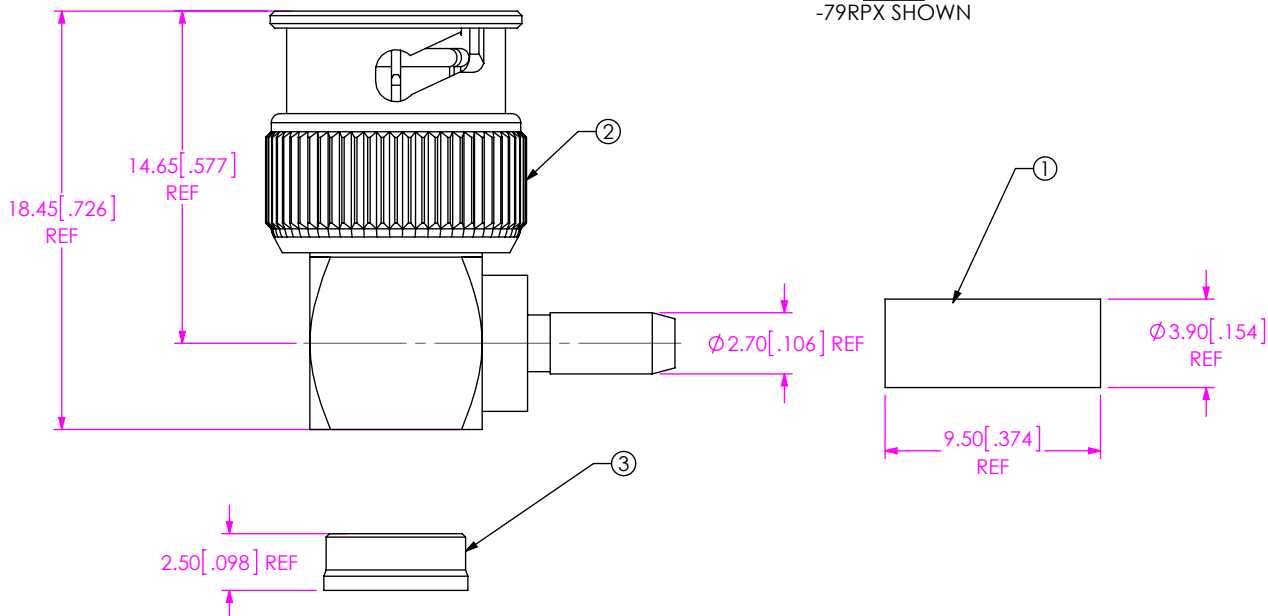

FIG 8
-79RPX SHOWN



BOM			
ITEM	COMPONENT	-79RP2	-79RP3
1	FERRULE	SMA-FER-001-N	
2	SUB ASSEMBLY	SUB-MBNC7-P-C-HN-RA-CA3	SUB-MBNC7-P-C-GN-RA-CA3
3	CAP	MBNC7-P-C-N-RA-CAP	

F:\DWG\MISC\MKTG\RF179-XXXX-XXXX-XXXX-MKT.SLDDRW

PROPRIETARY NOTE
THIS DOCUMENT CONTAINS CONFIDENTIAL AND PROPRIETARY INFORMATION AND ALL DESIGN, MANUFACTURING, REPRODUCTION, USE, PATENT RIGHTS AND SALES RIGHTS ARE EXPRESSLY RESERVED BY SAMTEC, INC. THIS DOCUMENT SHALL NOT BE DISCLOSED, IN WHOLE OR PART, TO ANY UNAUTHORIZED PERSON OR ENTITY NOR REPRODUCED, TRANSFERRED OR INCORPORATED IN ANY OTHER PROJECT IN ANY MANNER WITHOUT THE EXPRESS WRITTEN CONSENT OF SAMTEC, INC.

DO NOT SCALE DRAWING

SHEET SCALE: 3:1



520 PARK EAST BLVD, NEW ALBANY, IN 47150
PHONE: 812-944-6733 FAX: 812-948-5047
e-Mail info@SAMTEC.com code 55322

DESCRIPTION:
RF179 CABLE ASSEMBLY

DWG. NO.
RF179-XXXX-XXXX-XXXX

BY: B. RAY 1-30-2007 SHEET 5 OF 10

FIG 9
-79SPX SHOWN

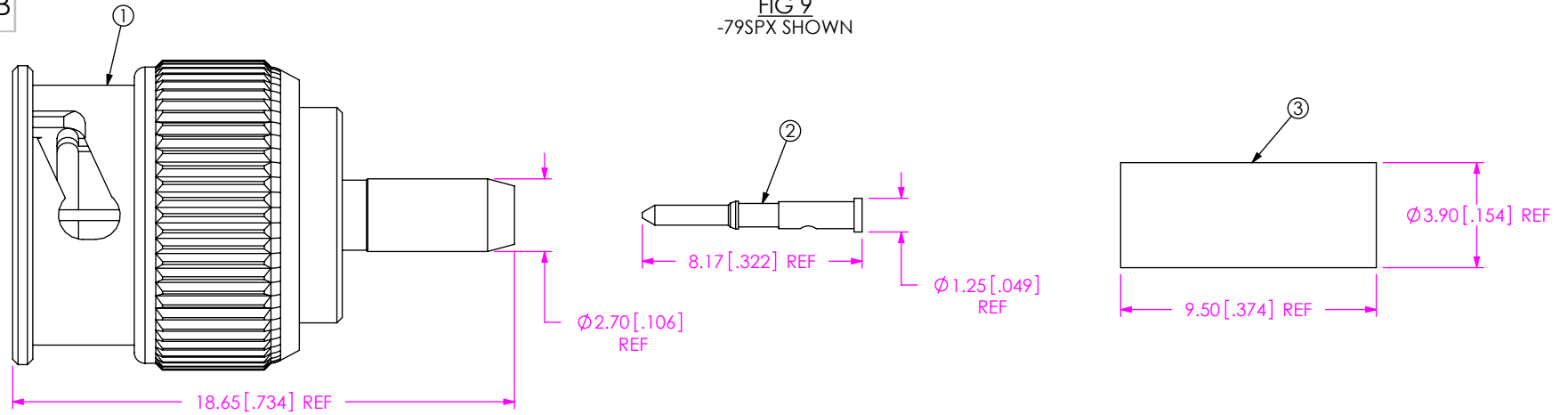

BOM			
ITEM	COMPONENT	-79SP2	-79SP3
1	SUB ASSEMBLY	SUB-MBNC7-P-C-N-ST-CA3	
2	PIN	MBNC7-P-C-H-ST-CA3-PIN	MBNC7-P-C-G-ST-CA3-PIN
3	FERRULE	SMA-FER-001-N	

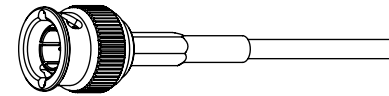
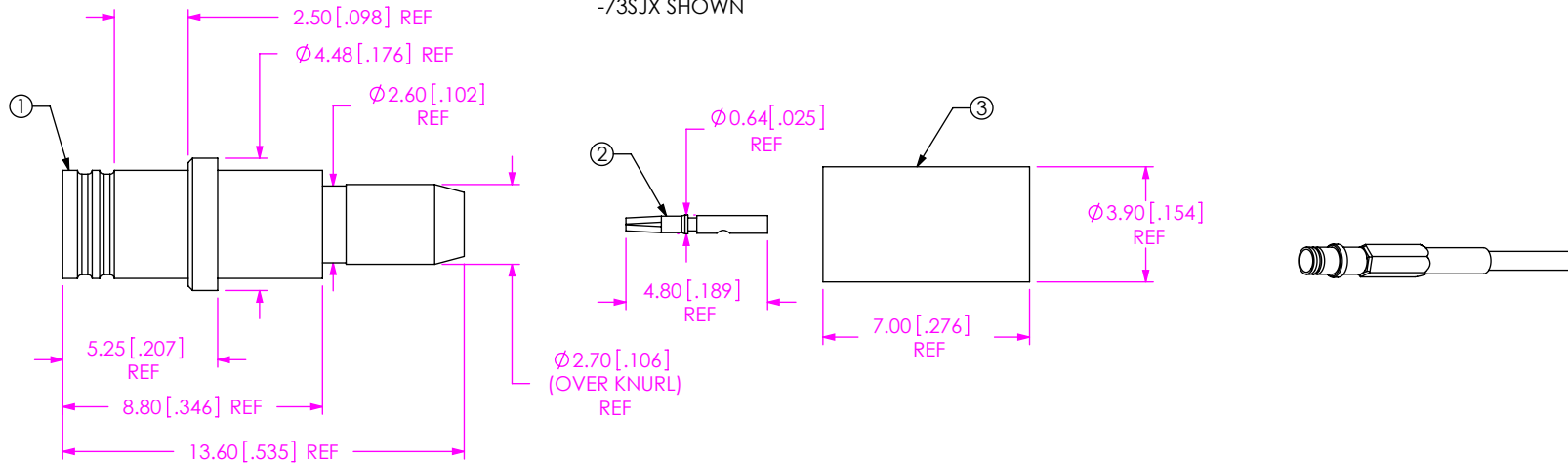

FIG 10
-73SJX SHOWN



BOM			
ITEM	COMPONENT	-73SJ1	-73SJ4
1	SUB ASSEMBLY	SUB-GRF7V-J-C-FF-ST-CA3	SUB-GRF7V-J-C-FN-ST-CA3
2	SOCKET	GRF7-J-C-H-ST-SKT	GRF7-J-C-G-ST-SKT
3	FERRULE	MCX-FER-001-F	MCX-FER-001-N

F:\DWG\MISC\MKTG\RF179-XXXX-XXXX-XXXX-MKT.SLDDRW

PROPRIETARY NOTE
THIS DOCUMENT CONTAINS CONFIDENTIAL AND PROPRIETARY INFORMATION AND ALL DESIGN, MANUFACTURING, REPRODUCTION, USE, PATENT RIGHTS AND SALES RIGHTS ARE EXPRESSLY RESERVED BY SAMTEC, INC. THIS DOCUMENT SHALL NOT BE DISCLOSED, IN WHOLE OR PART, TO ANY UNAUTHORIZED PERSON OR ENTITY NOR REPRODUCED, TRANSFERRED OR INCORPORATED IN ANY OTHER PROJECT IN ANY MANNER WITHOUT THE EXPRESS WRITTEN CONSENT OF SAMTEC, INC.

DO NOT SCALE DRAWING

SHEET SCALE: 4:1



520 PARK EAST BLVD, NEW ALBANY, IN 47150
PHONE: 812-944-6733 FAX: 812-948-5047
e-Mail info@SAMTEC.com code 55322

DESCRIPTION:
RF179 CABLE ASSEMBLY

DWG. NO.
RF179-XXXX-XXXX-XXXX

BY: B. RAY 1-30-2007 SHEET 6 OF 10

FIG 11
-73RPX SHOWN

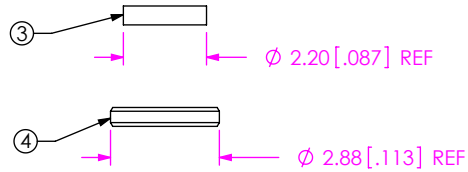
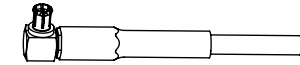
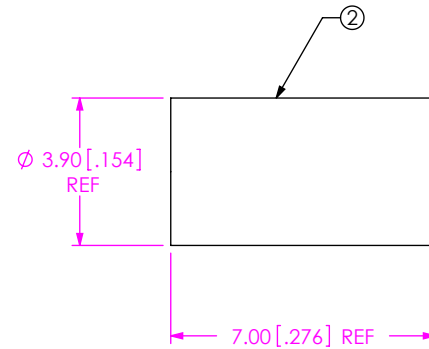
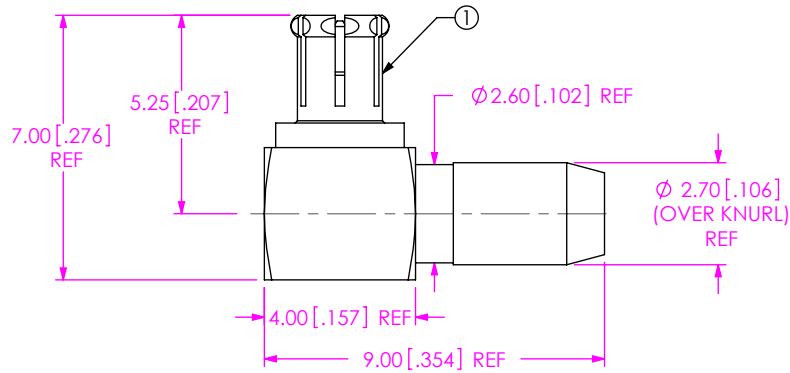

BOM			
ITEM	COMPONENT	-73RP1	-73RP4
1	SUB ASSEMBLY	SUB-GRF7V-P-C-HF-RA-CA3	SUB-GRF7V-P-C-GF-RA-CA3
2	FERRULE	MCX-FER-001-F	MCX-FER-001-N
3	INSULATOR		MMCX-INS-001
4	CAP	MMCX-CAP-001-F	MMCX-CAP-001-N

FIG 12
-73SPX SHOWN

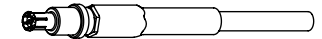
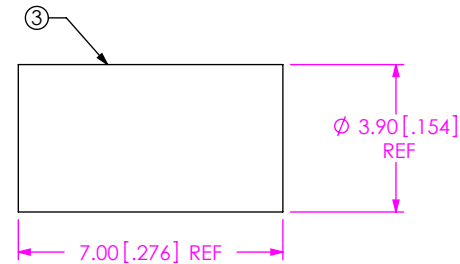
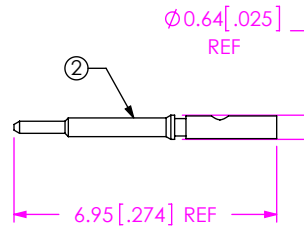
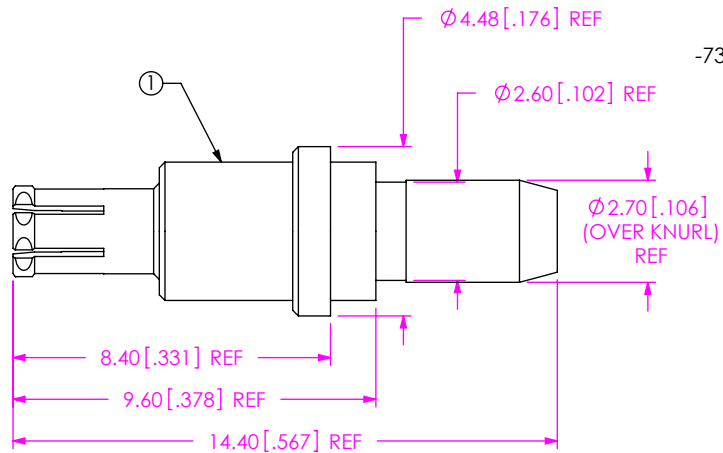

BOM			
ITEM	COMPONENT	-73SP1	-73SP4
1	SUB ASSEMBLY	SUB-GRF7-P-C-FF-ST-CA3	SUB-GRF7-P-C-FN-ST-CA3
2	PIN	GRF7-P-C-H-ST-PIN	GRF7-P-C-G-ST-PIN
3	FERRULE	MCX-FER-001-F	MCX-FER-001-N

F:\DWG\MISC\MKTG\RF179-XXXX-XXXX-XXXX-MKT.SLDDRW

PROPRIETARY NOTE
THIS DOCUMENT CONTAINS CONFIDENTIAL AND PROPRIETARY INFORMATION AND ALL DESIGN, MANUFACTURING, REPRODUCTION, USE, PATENT RIGHTS AND SALES RIGHTS ARE EXPRESSLY RESERVED BY SAMTEC, INC. THIS DOCUMENT SHALL NOT BE DISCLOSED, IN WHOLE OR PART, TO ANY UNAUTHORIZED PERSON OR ENTITY NOR REPRODUCED, TRANSFERRED OR INCORPORATED IN ANY OTHER PROJECT IN ANY MANNER WITHOUT THE EXPRESS WRITTEN CONSENT OF SAMTEC, INC.

DO NOT SCALE DRAWING

SHEET SCALE: 5:1



520 PARK EAST BLVD, NEW ALBANY, IN 47150
PHONE: 812-944-6733 FAX: 812-948-5047
e-Mail info@SAMTEC.com code 55322

DESCRIPTION:
RF179 CABLE ASSEMBLY

DWG. NO.
RF179-XXXX-XXXX-XXXX

BY: B. RAY 1-30-2007 SHEET 7 OF 10

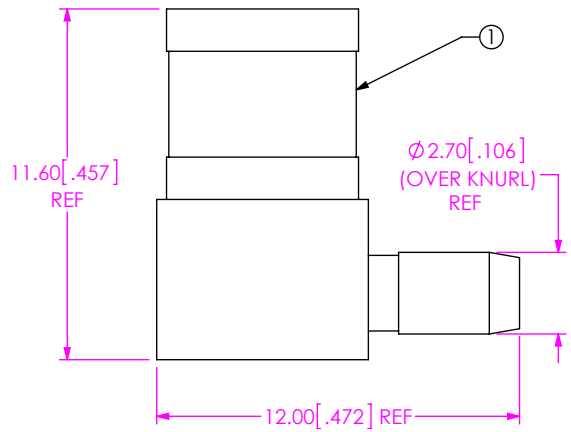
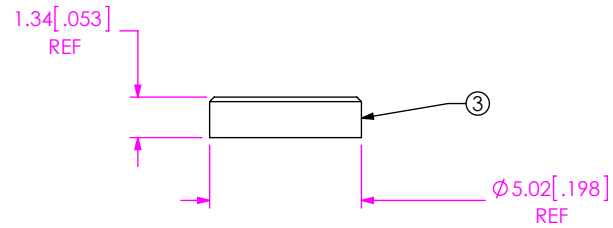
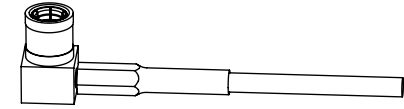
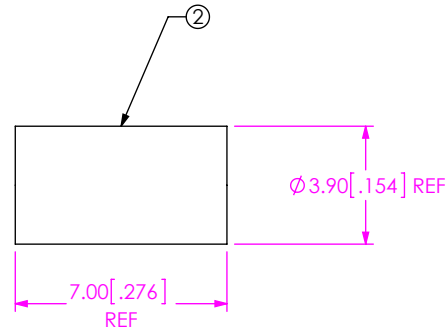
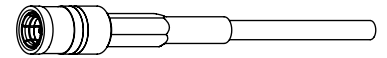
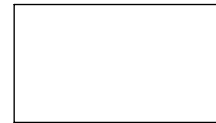
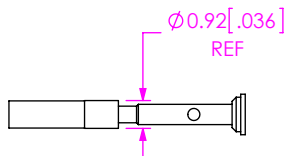
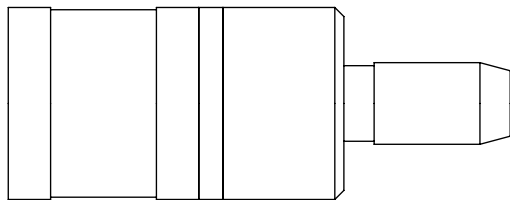

FIG 13
-77RPX SHOWN



BOM			
ITEM	COMPONENT	-77RP1	-77RP2
1	SUB ASSEMBLY	SUB-SMB7H-P-C-H-RA-CA3	SUB-SMB7H-P-C-HN-RA-CA3
2	FERRULE	MCX-FER-001-F	MCX-FER-001-N
3	CAP	SMB7-CAP-001-F	SMB7-CAP-001-N

FIG 14
-77SPX SHOWN



BOM			
ITEM	COMPONENT	-77SP2	-77SP1
1	SUB ASSEMBLY	SUB-SMB7H-P-C-FN-ST-CA3	SUB-SMB7H-P-C-F-ST-CA3
2	SOCKET	SMB7H-P-C-H-ST-CA3-SKT	
3	FERRULE	MCX-FER-001-N	MCX-FER-001-F

• PROPRIETARY NOTE •
THIS DOCUMENT CONTAINS CONFIDENTIAL AND PROPRIETARY INFORMATION AND ALL DESIGN, MANUFACTURING, REPRODUCTION, USE, PATENT RIGHTS AND SALES RIGHTS ARE EXPRESSLY RESERVED BY SAMTEC, INC. THIS DOCUMENT SHALL NOT BE DISCLOSED, IN WHOLE OR PART, TO ANY UNAUTHORIZED PERSON OR ENTITY NOR REPRODUCED, TRANSFERRED OR INCORPORATED IN ANY OTHER PROJECT IN ANY MANNER WITHOUT THE EXPRESS WRITTEN CONSENT OF SAMTEC, INC.

DO NOT SCALE DRAWING

SHEET SCALE: 4:1



520 PARK EAST BLVD, NEW ALBANY, IN 47150
PHONE: 812-944-6733 FAX: 812-948-5047
e-Mail: info@SAMTEC.com code 55322

DESCRIPTION:
RF179 CABLE ASSEMBLY

DWG. NO.
RF179-XXXXX-XXXXXX-XXXX

BY: B. RAY 1-30-2007 SHEET 8 OF 10

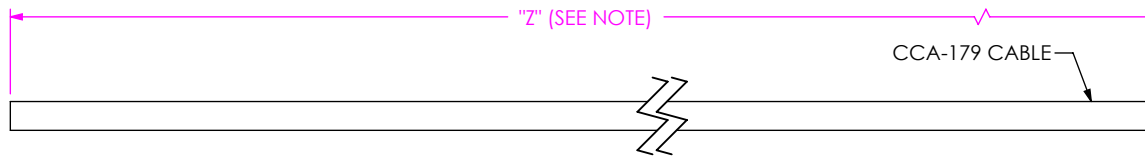

IN PROCESS 1
CUT CABLE TO LENGTH

NOTE: "Z" = 2*OAL-2*["Y"(END 1)] (FOR -SING OR -XXXXXX OPTIONS)
"Z" = OAL-"Y"(END 1)-"Y"(END 2) (FOR DOUBLE ENDED OPTIONS)

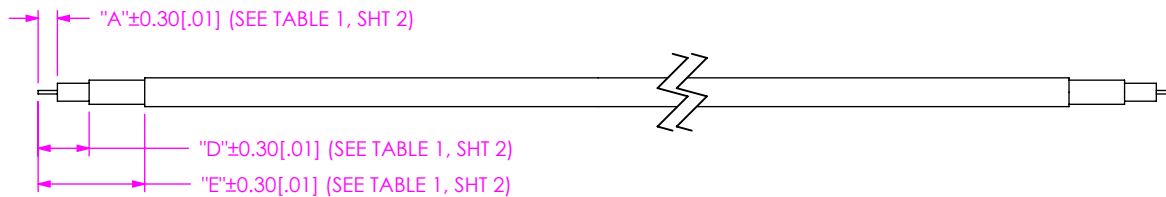

IN PROCESS 2
STRIP AND TIN INNER CONDUCTOR

STRAIGHT
IN PROCESS 3
ADD FERRULE & HEAT SHRINK TUBE,
SOLDER SIGNAL PIN

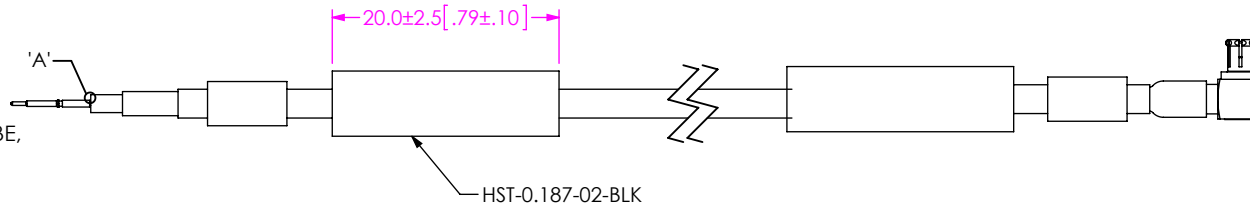

RIGHT ANGLE
IN PROCESS 3
ADD FERRULE & HEAT SHRINK TUBE,
FLARE SHIELD, ADD SUB ASSEMBLY
(SEE NOTE 6)

STRAIGHT
IN PROCESS 4
FLARE SHIELD,
ADD SUB ASSEMBLY
(SEE NOTE 6)

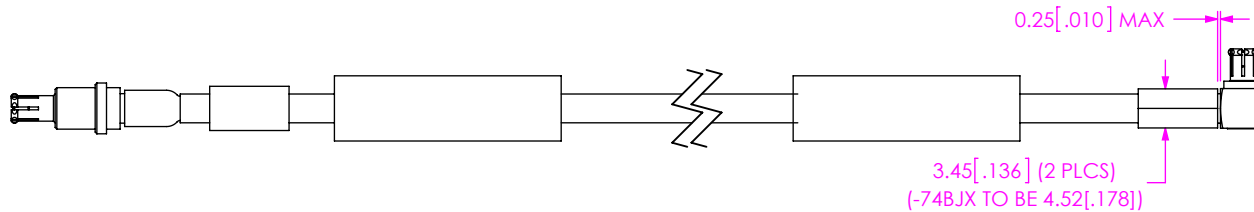

RIGHT ANGLE
IN-PROCESS 4
CRIMP FERRULE

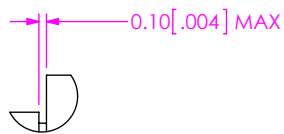

DETAIL 'A'
SCALE 10:1

PROPRIETARY NOTE
THIS DOCUMENT CONTAINS CONFIDENTIAL AND PROPRIETARY INFORMATION AND ALL DESIGN, MANUFACTURING, REPRODUCTION, USE, PATENT RIGHTS AND SALES RIGHTS ARE EXPRESSLY RESERVED BY SAMTEC, INC. THIS DOCUMENT SHALL NOT BE DISCLOSED, IN WHOLE OR PART, TO ANY UNAUTHORIZED PERSON OR ENTITY NOR REPRODUCED, TRANSFERRED OR INCORPORATED IN ANY OTHER PROJECT IN ANY MANNER WITHOUT THE EXPRESS WRITTEN CONSENT OF SAMTEC, INC.

DO NOT SCALE DRAWING

SHEET SCALE: 3:2

samtec

520 PARK EAST BLVD, NEW ALBANY, IN 47150
PHONE: 812-944-6733 FAX: 812-948-5047
e-Mail info@SAMTEC.com code 55322

DESCRIPTION: RF179 CABLE ASSEMBLY

DWG. NO. RF179-XXXXX-XXXXXX-XXXX

BY: B. RAY 1-30-2007 SHEET 9 OF 10

STRAIGHT
IN-PROCESS 5
CRIMP FERRULE

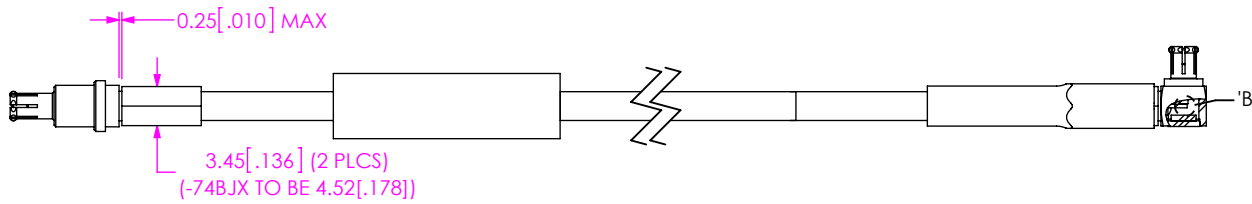

RIGHT ANGLE
IN-PROCESS 5
SOLDER SIGNAL PIN

STRAIGHT
IN PROCESS 6
ACTIVATE HEAT SHRINK

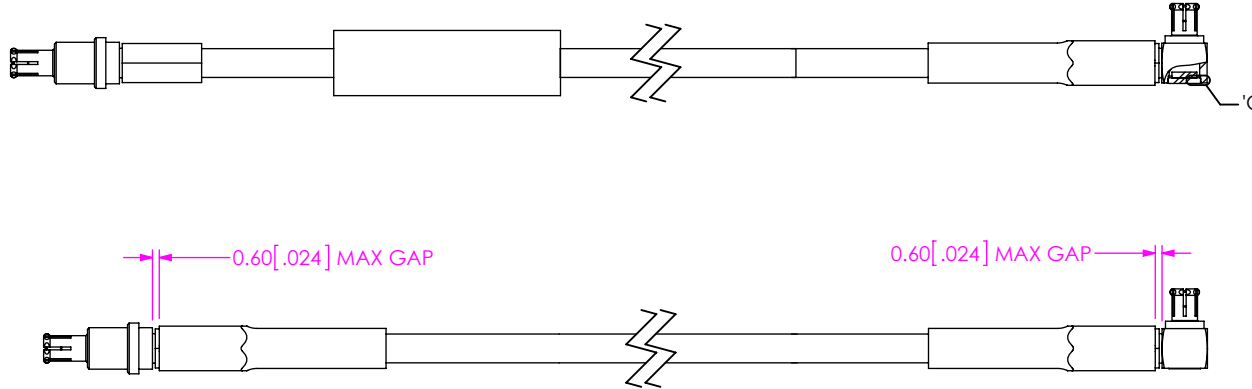

RIGHT ANGLE
IN-PROCESS 6
INSERT INSULATOR & CAP

RIGHT ANGLE
IN PROCESS 7
ACTIVATE HEAT SHRINK

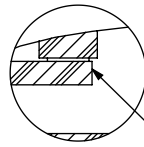

CABLE CENTER CONDUCTOR
SHOULD NOT PROTRUDE
OUTSIDE CONTACT CUP

DETAIL 'B'
SCALE 10 : 1

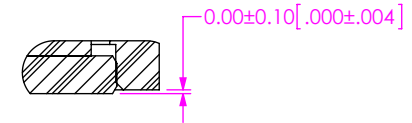

DETAIL 'C'
SCALE 10 : 1

F:\DWG\MISC\MKTG\RF179-XXXX-XXXX-XXXX-MKT.SLDDRW

PROPRIETARY NOTE
THIS DOCUMENT CONTAINS CONFIDENTIAL AND PROPRIETARY INFORMATION AND ALL DESIGN, MANUFACTURING, REPRODUCTION, USE, PATENT RIGHTS AND SALES RIGHTS ARE EXPRESSLY RESERVED BY SAMTEC, INC. THIS DOCUMENT SHALL NOT BE DISCLOSED, IN WHOLE OR PART, TO ANY UNAUTHORIZED PERSON OR ENTITY NOR REPRODUCED, TRANSFERRED OR INCORPORATED IN ANY OTHER PROJECT IN ANY MANNER WITHOUT THE EXPRESS WRITTEN CONSENT OF SAMTEC, INC.

DO NOT SCALE DRAWING

SHEET SCALE: 3:2



520 PARK EAST BLVD. NEW ALBANY, IN 47150
PHONE: 812-944-6733 FAX: 812-948-5047
e-Mail info@SAMTEC.com code 55322

DESCRIPTION: RF179 CABLE ASSEMBLY

DWG. NO. RF179-XXXX-XXXX-XXXX

BY: B. RAY 1-30-2007 SHEET 10 OF 10