

- Rugged Triple-Diffused Planar Construction
- 4 A Continuous Collector Current
- Operating Characteristics Fully Guaranteed at 100°C
- 1200 Volt Blocking Capability
- 75 W at 25°C Case Temperature

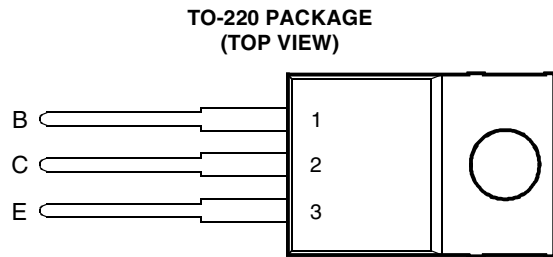

Pin 2 is in electrical contact with the mounting base.

MDTRACA

absolute maximum ratings at 25°C case temperature (unless otherwise noted)

RATING		SYMBOL	VALUE	UNIT
Collector-base voltage ($I_E = 0$)	TIPL760B	V_{CBO}	1100	V
	TIPL760C		1200	
Collector-emitter voltage ($V_{BE} = 0$)	TIPL760B	V_{CES}	1100	V
	TIPL760C		1200	
Collector-emitter voltage ($I_B = 0$)	TIPL760B	V_{CEO}	500	V
	TIPL760C		550	
Emitter-base voltage		V_{EBO}	10	V
Continuous collector current		I_C	4	A
Peak collector current (see Note 1)		I_{CM}	8	A
Continuous device dissipation at (or below) 25°C case temperature		P_{tot}	75	W
Operating junction temperature range		T_j	-65 to +150	°C
Storage temperature range		T_{stg}	-65 to +150	°C

NOTE 1: This value applies for $t_p \leq 10$ ms, duty cycle $\leq 2\%$.

PRODUCT INFORMATION

electrical characteristics at 25°C case temperature (unless otherwise noted)

PARAMETER	TEST CONDITIONS			MIN	TYP	MAX	UNIT
$V_{CE(sus)}$ Collector-emitter sustaining voltage	$I_C = 10 \text{ mA}$	$L = 25 \text{ mH}$	(see Note 2)	TIPL760B TIPL760C	500 550		V
I_{CES} Collector-emitter cut-off current	$V_{CE} = 1100 \text{ V}$	$V_{BE} = 0$		TIPL760B		50	μA
	$V_{CE} = 1200 \text{ V}$	$V_{BE} = 0$		TIPL760C		50	
	$V_{CE} = 1100 \text{ V}$	$V_{BE} = 0$	$T_C = 100^\circ\text{C}$	TIPL760B		200	
	$V_{CE} = 1200 \text{ V}$	$V_{BE} = 0$	$T_C = 100^\circ\text{C}$	TIPL760C		200	
I_{CEO} Collector cut-off current	$V_{CE} = 500 \text{ V}$	$I_B = 0$		TIPL760B		50	μA
	$V_{CE} = 550 \text{ V}$	$I_B = 0$		TIPL760C		50	
I_{EBO} Emitter cut-off current	$V_{EB} = 10 \text{ V}$	$I_C = 0$				1	mA
h_{FE} Forward current transfer ratio	$V_{CE} = 5 \text{ V}$	$I_C = 0.5 \text{ A}$	(see Notes 3 and 4)		20	60	
$V_{CE(sat)}$ Collector-emitter saturation voltage	$I_B = 0.4 \text{ A}$	$I_C = 2 \text{ A}$				1.0	V
	$I_B = 0.6 \text{ A}$	$I_C = 3 \text{ A}$	(see Notes 3 and 4)			2.5	
	$I_B = 0.6 \text{ A}$	$I_C = 3 \text{ A}$	$T_C = 100^\circ\text{C}$			5.0	
$V_{BE(sat)}$ Base-emitter saturation voltage	$I_B = 0.4 \text{ A}$	$I_C = 2 \text{ A}$				1.2	V
	$I_B = 0.6 \text{ A}$	$I_C = 3 \text{ A}$	(see Notes 3 and 4)			1.4	
	$I_B = 0.6 \text{ A}$	$I_C = 3 \text{ A}$	$T_C = 100^\circ\text{C}$			1.3	
f_t Current gain bandwidth product	$V_{CE} = 10 \text{ V}$	$I_C = 0.5 \text{ A}$	$f = 1 \text{ MHz}$		12		MHz
C_{ob} Output capacitance	$V_{CB} = 20 \text{ V}$	$I_E = 0$	$f = 0.1 \text{ MHz}$		110		pF

NOTES: 2. Inductive loop switching measurement.

3. These parameters must be measured using pulse techniques, $t_p = 300 \mu\text{s}$, duty cycle $\leq 2\%$.

4. These parameters must be measured using voltage-sensing contacts, separate from the current carrying contacts.

thermal characteristics

PARAMETER	MIN	TYP	MAX	UNIT
$R_{\theta JC}$ Junction to case thermal resistance			1.56	$^\circ\text{C/W}$

inductive-load-switching characteristics at 25°C case temperature (unless otherwise noted)

PARAMETER	TEST CONDITIONS †			MIN	TYP	MAX	UNIT
t_{sv} Voltage storage time	$I_C = 3 \text{ A}$ $V_{BE(off)} = -5 \text{ V}$	$I_{B(on)} = 0.6 \text{ A}$	(see Figures 1 and 2)			2.5	μs
t_{rv} Voltage rise time						300	ns
t_{fi} Current fall time						250	ns
t_{ti} Current tail time						150	ns
t_{xo} Cross over time						400	ns
t_{sv} Voltage storage time				$I_C = 3 \text{ A}$ $V_{BE(off)} = -5 \text{ V}$	$I_{B(on)} = 0.6 \text{ A}$	(see Figures 1 and 2)	
t_{rv} Voltage rise time			500				ns
t_{fi} Current fall time			250				ns
t_{ti} Current tail time		$T_C = 100^\circ\text{C}$	150				ns
t_{xo} Cross over time			750				ns

† Voltage and current values shown are nominal; exact values vary slightly with transistor parameters.

PARAMETER MEASUREMENT INFORMATION

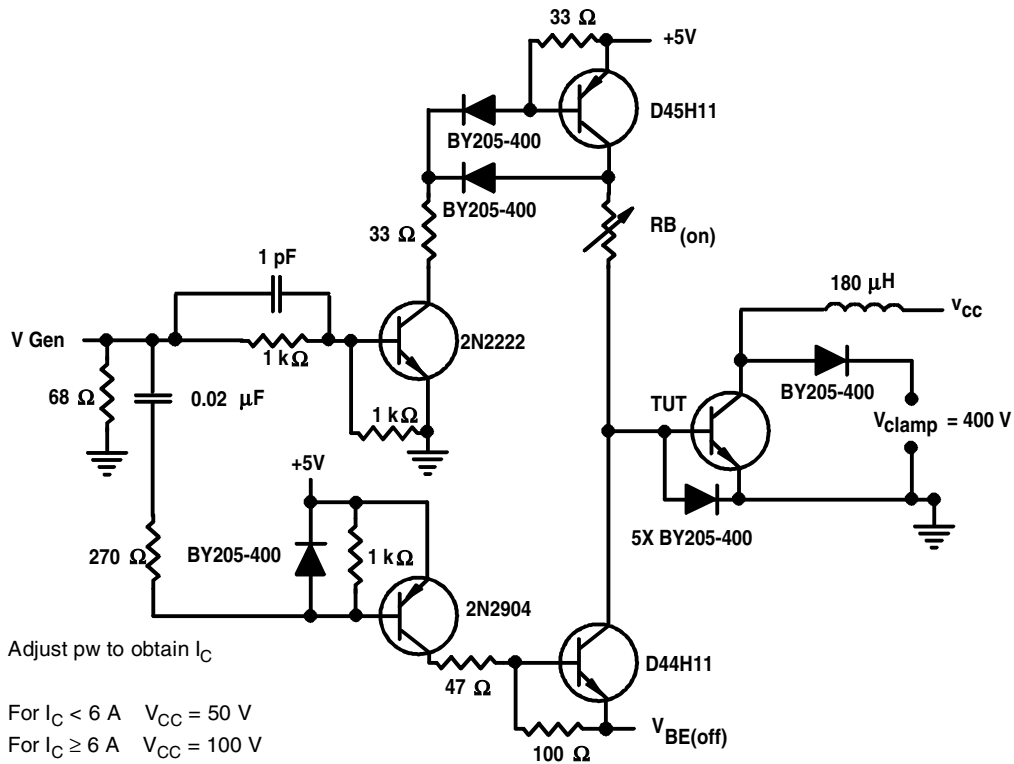
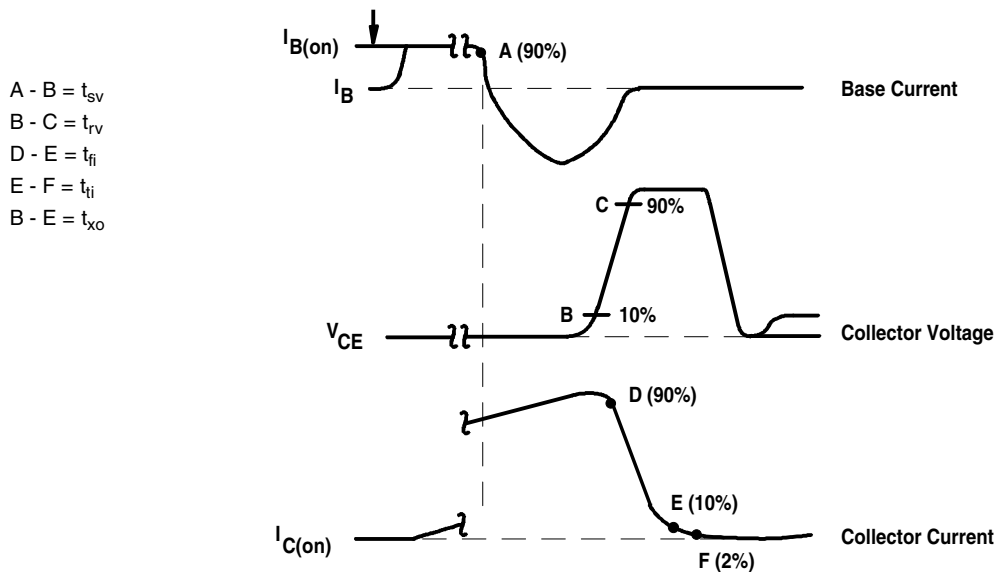

Figure 1. Inductive-Load Switching Test Circuit



NOTES: A. Waveforms are monitored on an oscilloscope with the following characteristics: $t_r < 15 \text{ ns}$, $R_{in} > 10 \Omega$, $C_{in} < 11.5 \text{ pF}$.
 B. Resistors must be noninductive types.

Figure 2. Inductive-Load Switching Waveforms

PRODUCT INFORMATION

TYPICAL CHARACTERISTICS

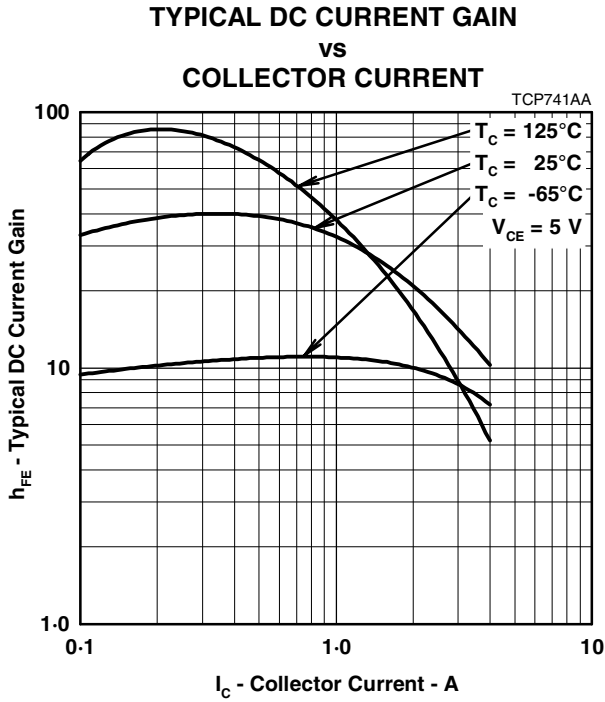

Figure 3.

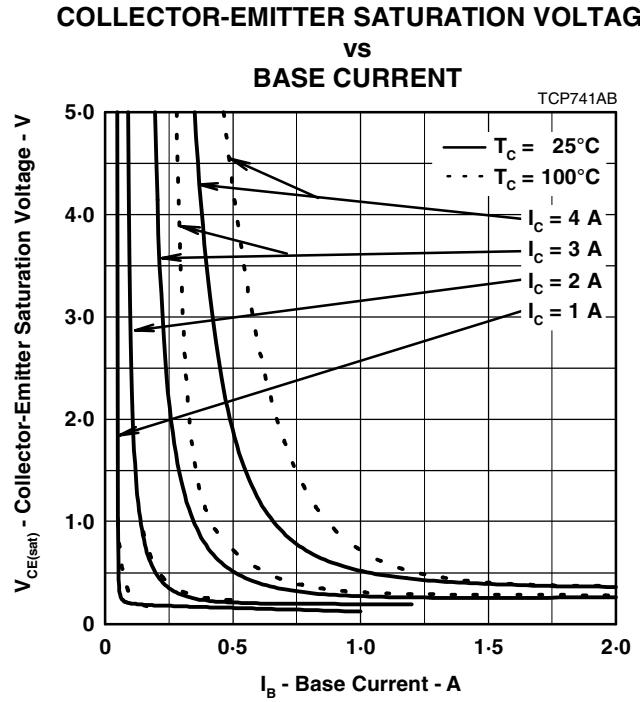

Figure 4.

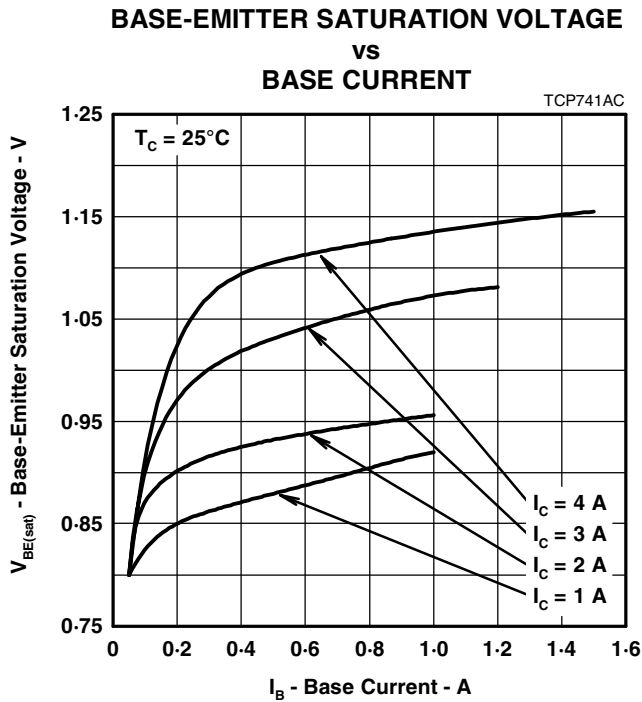

Figure 5.

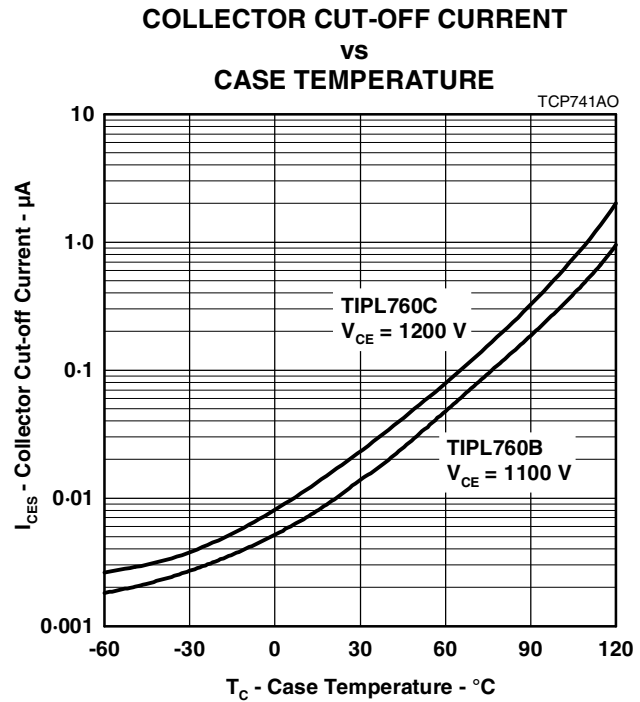

Figure 6.

PRODUCT INFORMATION

MAXIMUM SAFE OPERATING REGIONS

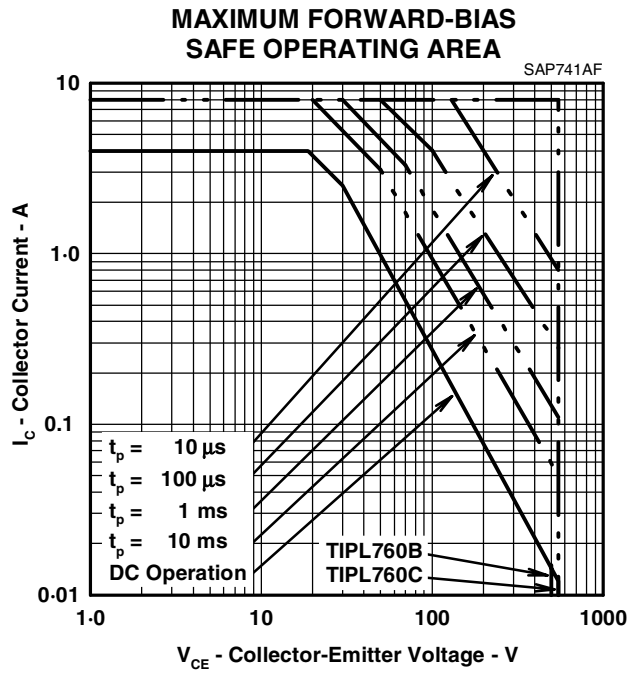

Figure 7.

THERMAL INFORMATION

**THERMAL RESPONSE JUNCTION TO CASE
VS
POWER PULSE DURATION**

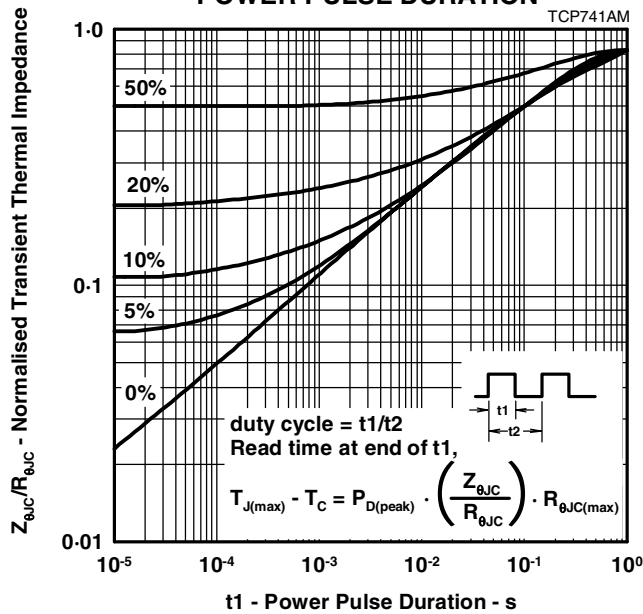

Figure 8.

PRODUCT INFORMATION

MAY 1989 - REVISED SEPTEMBER 2002
Specifications are subject to change without notice.