

SERIES 100 SWITCHES

TOGGLE SWITCHES - MINIATURE



SPECIFICATIONS

| | |
|------------------------|--|
| Contact Rating: | See contact material options |
| Life Expectancy: | 40,000 make-and-break cycles at full load |
| Contact Resistance: | 100 mΩ max. typical initial @ 2-4 VDC 100 mA for both silver and gold plated contacts |
| Insulation Resistance: | 1,000 MΩ min. |
| Dielectric Strength: | 1,000 V RMS @ sea level |
| Operating Temperature: | -30° C to 85° C |

MATERIALS

| | |
|-----------------------|------------------------------------|
| Case: | Diallyl Phthalate (DAP) |
| Toggle Handle: | Brass, chrome plated |
| Switch Support: | Brass or steel, tin plated |
| Bushing: | Brass, nickel plated |
| Housing: | Stainless steel |
| Contacts / Terminals: | Silver or gold plated copper alloy |

FEATURES & BENEFITS

- ▶ Up to 4 poles available
- ▶ Variety of switching functions
- ▶ Miniature
- ▶ Multiple actuator & bushing options

APPLICATIONS/MARKETS

- ▶ Telecommunications
- ▶ Instrumentation
- ▶ Networking
- ▶ Medical equipment

HOW TO ORDER

| SERIES 100 | MODEL NO. | ACTUATOR | BUSHING | TERMINATION | CONTACT MATERIAL | SEAL | HARDWARE |
|---------------|-----------|--|---------|-------------|------------------------|---|--------------|
| | SP1 | T1† | B1 | M1 | Q = Silver R = Gold | E = Epoxy Sealed at Base of Terminal | H = Hardware |
| | SP2* | T2 | B2 | M2 | | | |
| | SP3 | T3 | B3 | M3 | | | |
| | SP4* | T4 | B4 | M5 | | | |
| | SP5* | T5 | B5 | M6 | | | |
| | DP1 | T6 | B6 | M61 | | | |
| | DP2* | T7 | B8 | M7 | | | |
| | DP3 | T8 | B9 | M71 | | | |
| | DP4* | T9 | B11 | VS2 | | | |
| | DP5* | K1 | B12 | VS3 | | | |
| | DP6 | K2 | B13 | VS5* | | | |
| | DP7* | | B15 | M64* | | | |
| | DP8* | † Optional Toggle Cap (T1 Only): T100-1 = White T100-2 = Black | B16 | VS21* | | | |
| | 3P1 | | B25** | VS31* | | | |
| | 3P2* | | B26** | | | | |
| | 3P3 | | | | | | |
| | 3P4* | | | | | | |
| | 3P5* | | | | | | |
| | 4P1 | | | | | | |
| | 4P2* | | | | | | |
| | 4P3 | | | | | | |
| | 4P4* | | | | | | |
| | 4P5* | | | | | | |
| | 4P6 | | | | | | |
| | 4P7* | | | | | | |
| | 4P8* | | | | | | |



Example Ordering Number
100-SP1-T4-B2-M1-R-E

Notes: * Not available with the K1 and K2 actuator options.

** Available only with the K1 and K2 actuator options.

Specifications subject to change without notice.



SPDT



SCHEMATIC

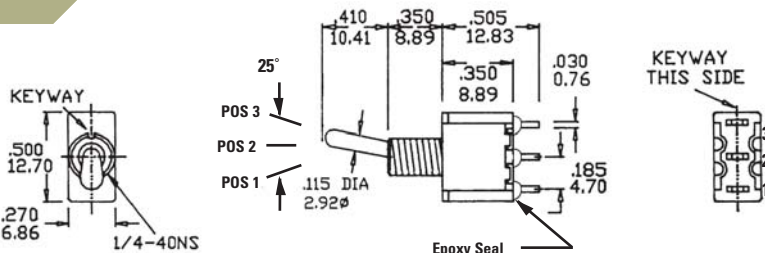

| Model No. | POS 1 | POS 2 | POS 3 |
|-------------|-------|-------|-------|
| SP-1 | ON | NONE | ON |
| SP-2 | ON | NONE | (ON) |
| SP-3 | ON | OFF | ON |
| SP-4 | (ON) | OFF | (ON) |
| SP-5 | ON | OFF | (ON) |
| Term. Comm. | 2-3 | OPEN | 2-1 |

() = Momentary

DPDT

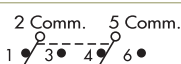

SCHEMATIC

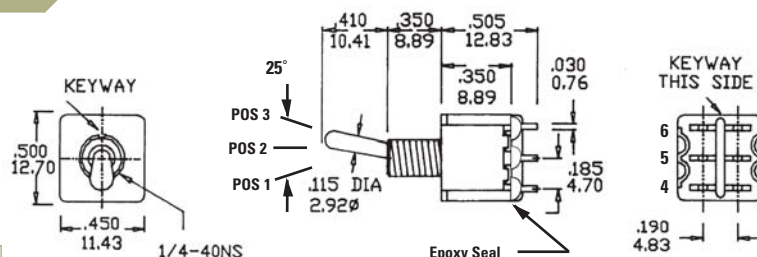

| Model No. | POS 1 | POS 2 | POS 3 |
|-------------|----------|-------|----------|
| DP-1 | ON | NONE | ON |
| DP-2 | ON | NONE | (ON) |
| DP-3 | ON | OFF | ON |
| DP-4 | (ON) | OFF | (ON) |
| DP-5 | ON | OFF | (ON) |
| DP-7 | ON | ON | (ON) |
| DP-8 | (ON) | ON | (ON) |
| Term. Comm. | 2-3, 5-6 | OPEN | 2-1, 5-4 |

| | | | |
|-------------|----------|----------|----------|
| DP-6 | ON | ON | ON |
| Term. Comm. | 2-3, 5-6 | 2-3, 5-4 | 2-1, 5-4 |

() = Momentary

3PDT



SCHEMATIC



| Model No. | POS 1 | POS 2 | POS 3 |
|-------------|-----------------|-------|-----------------|
| 3P-1 | ON | NONE | ON |
| 3P-2 | ON | NONE | (ON) |
| 3P-3 | ON | OFF | ON |
| 3P-4 | (ON) | OFF | (ON) |
| 3P-5 | ON | OFF | (ON) |
| Term. Comm. | 2-3, 5-6 8-9 | OPEN | 2-1, 5-4 8-7 |

() = Momentary

4PDT

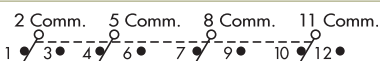

SCHEMATIC

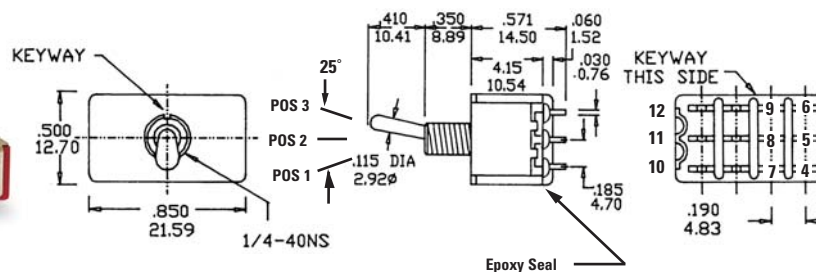

| Model No. | POS 1 | POS 2 | POS 3 |
|-------------|--------------------------|-------|--------------------------|
| 4P-1 | ON | NONE | ON |
| 4P-2 | ON | NONE | (ON) |
| 4P-3 | ON | OFF | ON |
| 4P-4 | (ON) | OFF | (ON) |
| 4P-5 | ON | OFF | (ON) |
| 4P-7 | ON | ON | (ON) |
| 4P-8 | (ON) | ON | (ON) |
| Term. Comm. | 2-3, 5-6 8-9 11-12 | OPEN | 2-1, 5-4 8-7 11-10 |

| | | | |
|-------------|--------------------------|--------------------------|--------------------------|
| 4P-6 | ON | ON | ON |
| Term. Comm. | 2-3, 5-6 8-9 11-12 | 2-3, 5-4 8-9 11-10 | 2-1, 5-4 8-7 11-10 |

() = Momentary

SERIES 100 SWITCHES

TOGGLE SWITCHES - MINIATURE

3 - WAY WIRING DIAGRAM SCHEMATICS

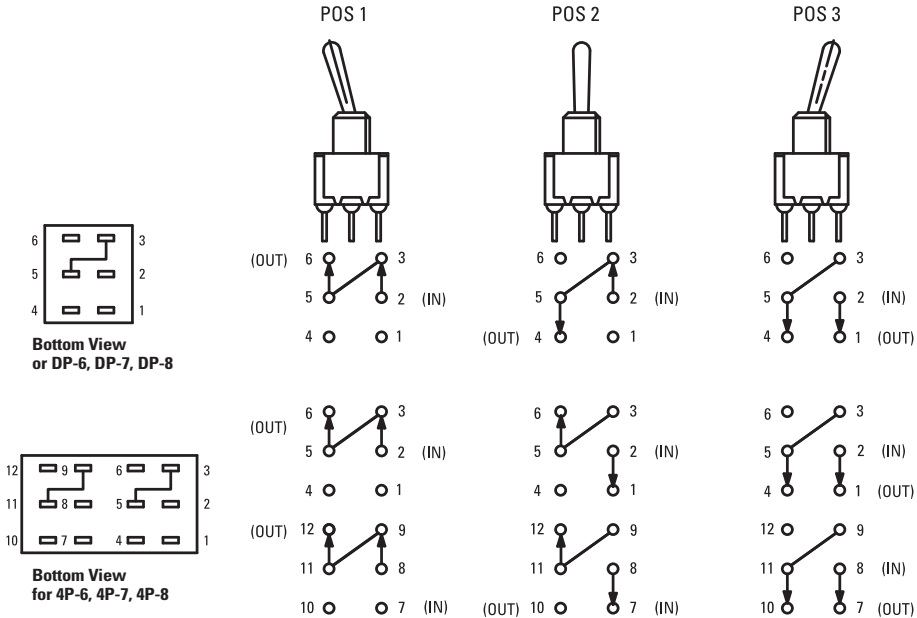

ACTUATOR OPTIONS

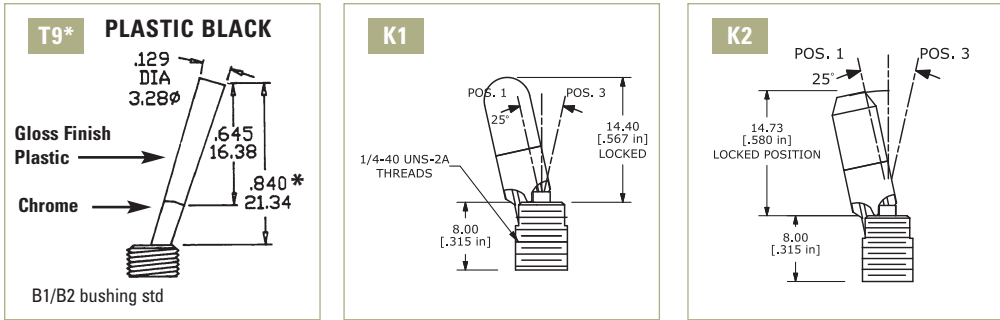
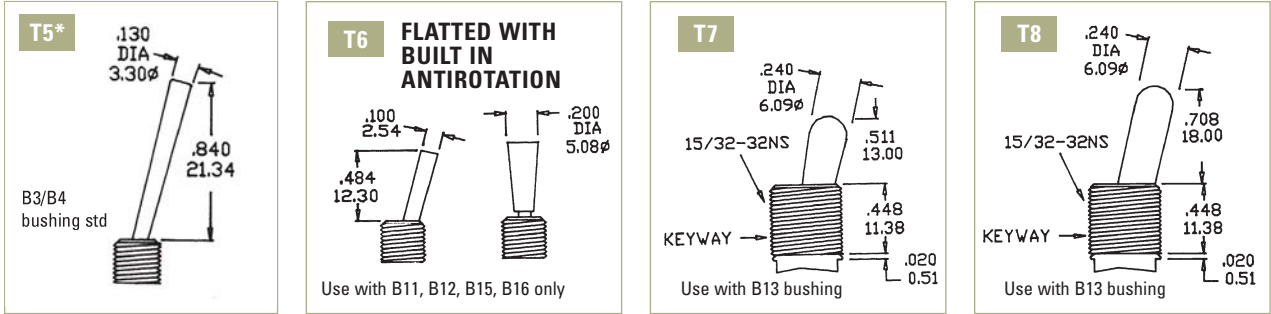
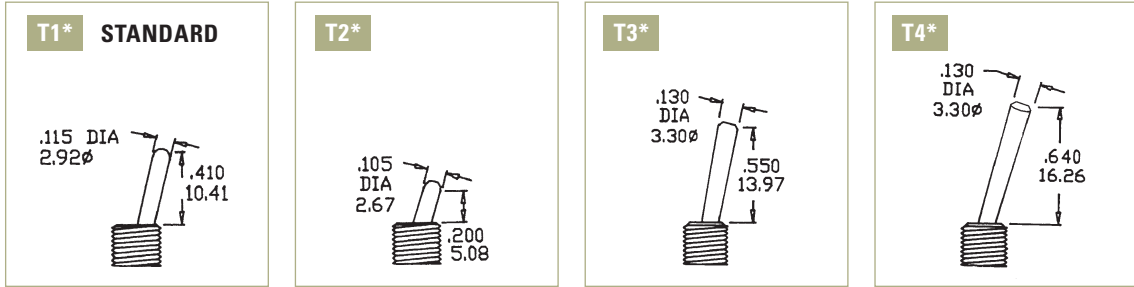

*Add .070 (1.78) for B3, B4 bushings, subtract .020 (0.51) for B6 bushing.

TACT SWITCHES

NAVIGATION SWITCHES

PUSHBUTTON SWITCHES

TOGGLE SWITCHES

ROCKER SWITCHES

SLIDE SWITCHES

SNAP-ACTION SWITCHES

DIP SWITCHES

KEYLOCK SWITCHES

ROTARY SWITCHES

DETECTOR SWITCHES

CAP OPTIONS



BUSHING OPTIONS

B1 THD STD

B2 NON-THD



B3 THD STD

B4 NON-THD



B4 is standard for M6, M7 and VS termination options.

B5 HIGH TORQUE



B6 HIGH TORQUE

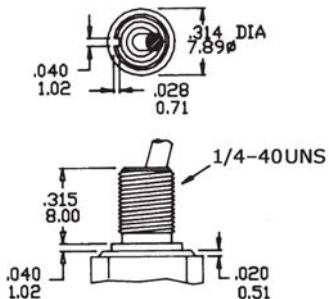

B8 METRIC THD

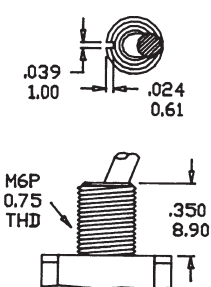

B9 SPLASH PROOF

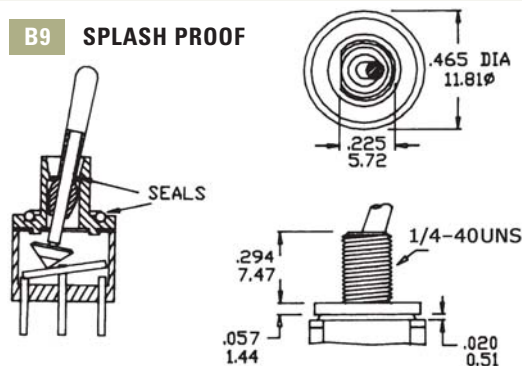

B13

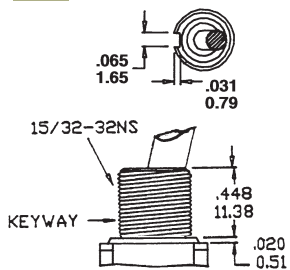

Use with T7 and T8 actuators only

B11 THD STD

B12 NON-THD

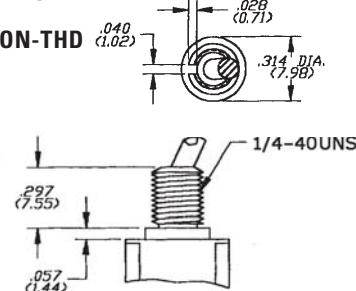

Use with T6 actuator only

B15 THD STD

B16 NON-THD

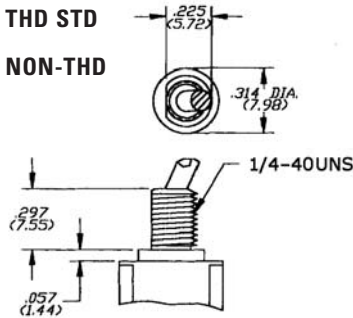

Use with T6 actuator only

B25

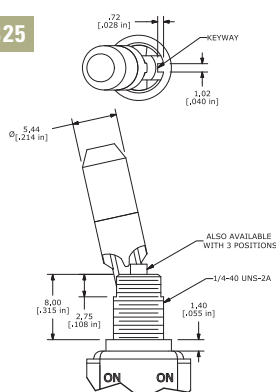

B26

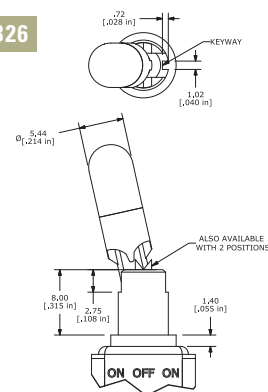

SERIES 100 SWITCHES

TOGGLE SWITCHES - MINIATURE

TACT SWITCHES

NAVIGATION SWITCHES

PUSHBUTTON SWITCHES

TOGGLE SWITCHES

ROCKER SWITCHES

SLIDE SWITCHES

SNAP-ACTION SWITCHES

DIP SWITCHES

KEYLOCK SWITCHES

ROTARY SWITCHES

DETECTOR SWITCHES

CAP OPTIONS

BUSHING OPTIONS - PANEL MOUNTING

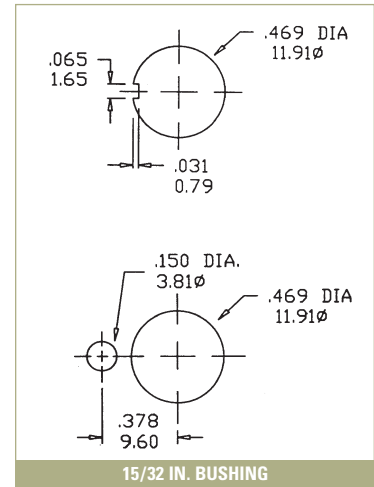
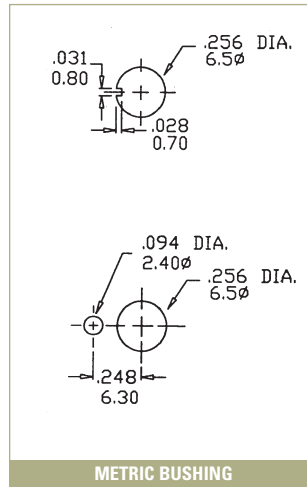
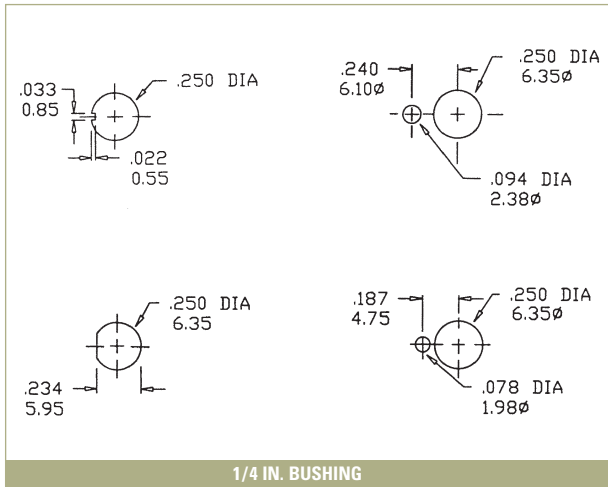

TERMINATION OPTIONS

M2

SPDT

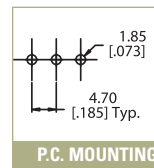
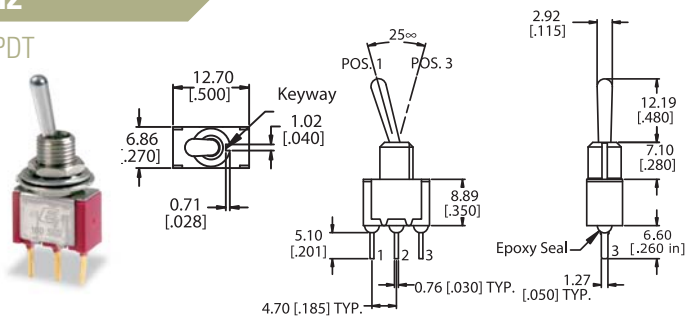

M1 SOLDER LUG

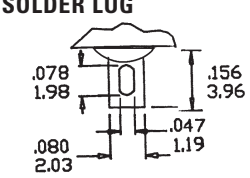

M3 QUICK CONNECT

Mating Quick Connector
Amp P/N 61454-1

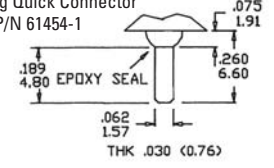

M2

DPDT

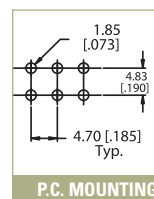
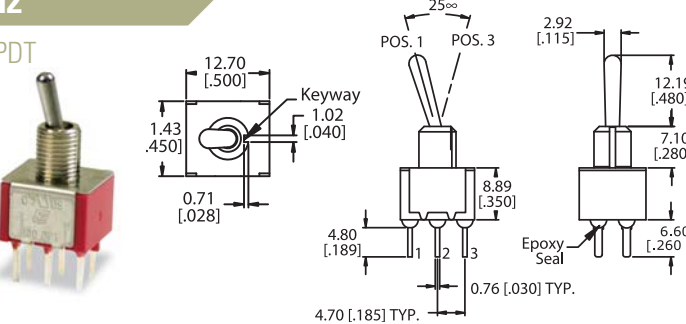

M5 WIRE WRAP

| Option Code | Dim. 'A' |
|-------------|---------------|
| M51 | .750 (18.7) |
| M52 | .964 (24.48) |
| M53 | .425 (10.80) |
| M54 | 1.062 (26.97) |

Dimensions: .075, 1.91, 'A' MAX, .050, 1.27, .030 THK (.076)

M6

SPDT

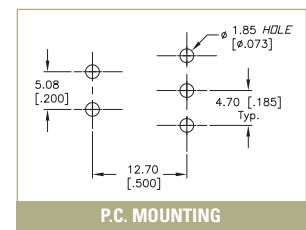
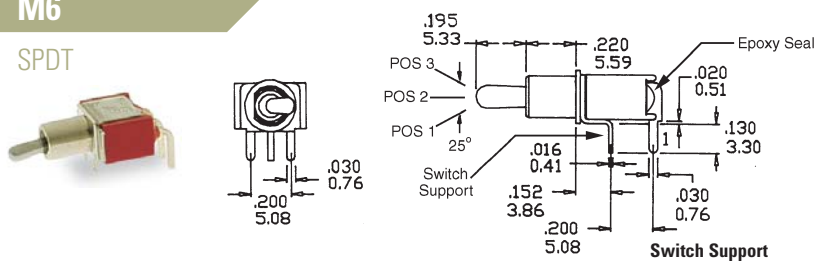



M6

DPDT

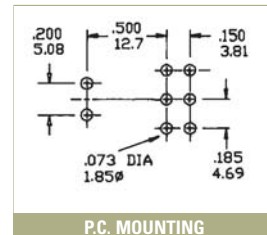
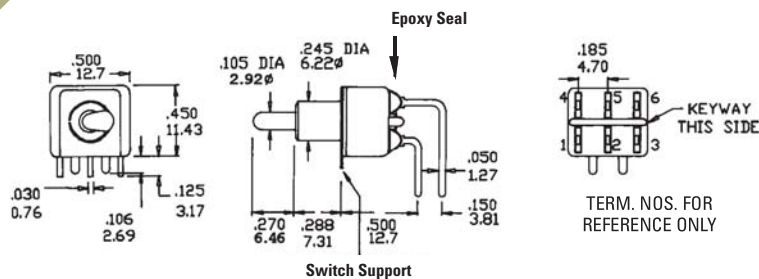

P.C. MOUNTING

M7

SPDT

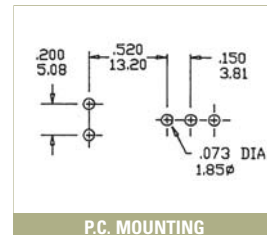
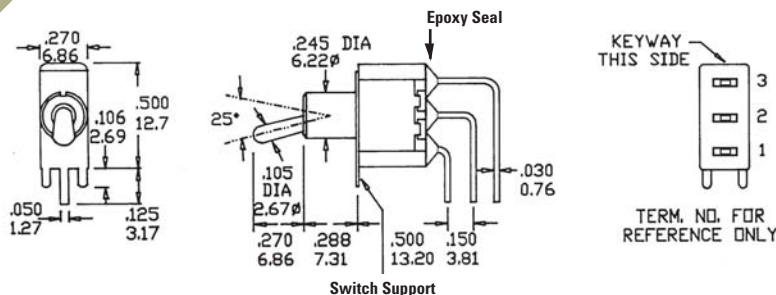

P.C. MOUNTING

M7

DPDT

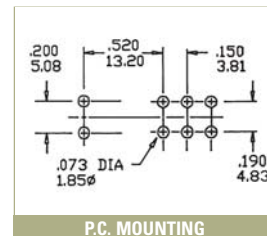
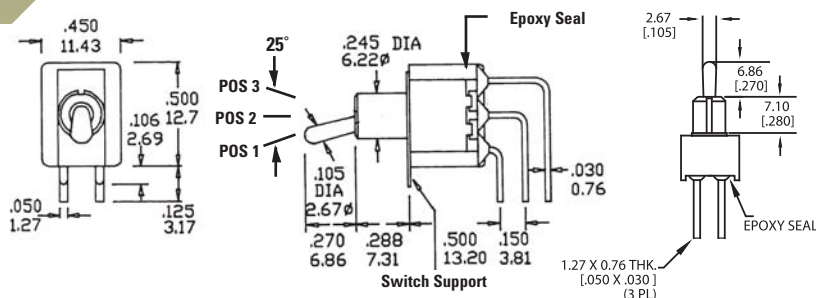

P.C. MOUNTING

M7

3PDT

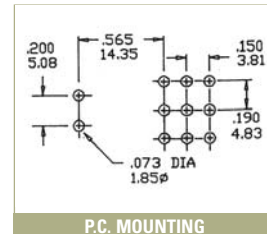
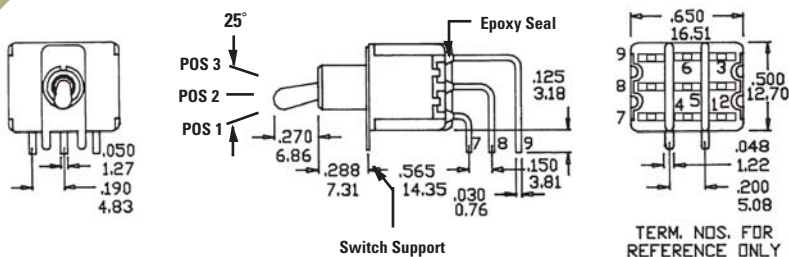

P.C. MOUNTING

M7

4PDT

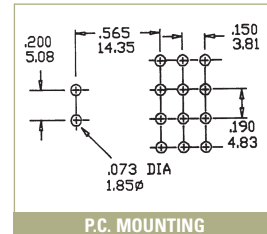
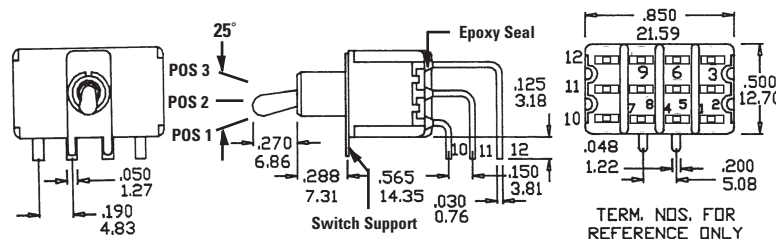

P.C. MOUNTING

SERIES 100 SWITCHES

TOGGLE SWITCHES - MINIATURE

TACT
SWITCHES

NAVIGATION
SWITCHES

PUSHBUTTON
SWITCHES

TOGGLE
SWITCHES

ROCKER
SWITCHES

SLIDE
SWITCHES

SNAP-ACTION
SWITCHES

DIP
SWITCHES

KEYLOCK
SWITCHES

ROTARY
SWITCHES

DETECTOR
SWITCHES

CAP
OPTIONS

VS2-VS3

SPDT

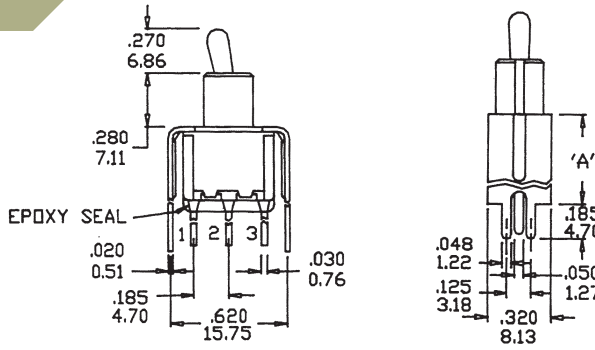

| Option Code | Dim. 'A' |
|-------------|--------------|
| VS2 | .460 (11.68) |
| VS3 | .630 (16.00) |

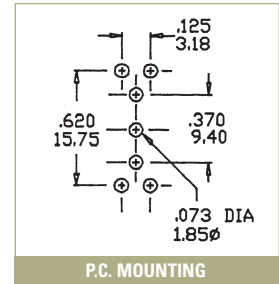

VS2-VS3

DPDT

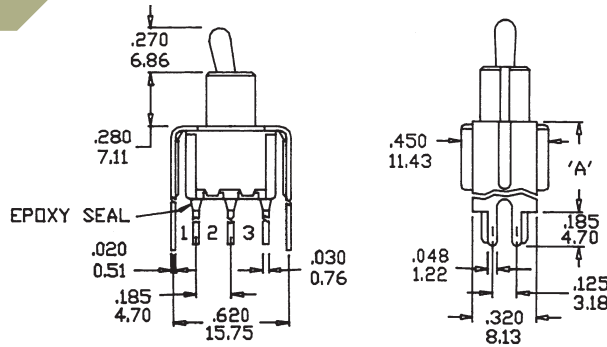

| Option Code | Dim. 'A' |
|-------------|--------------|
| VS2 | .460 (11.68) |
| VS3 | .630 (16.00) |

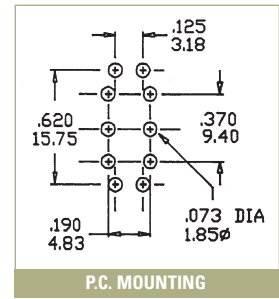

VS5

DPDT

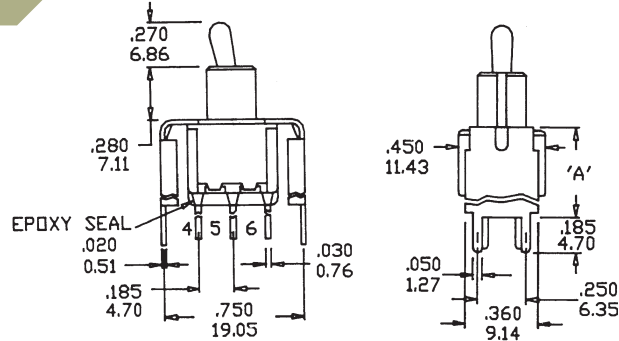

| Option Code | Dim. 'A' |
|-------------|--------------|
| VS5 | .630 (16.00) |

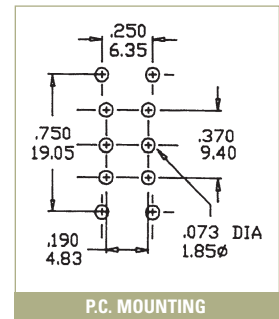

M61

SPDT

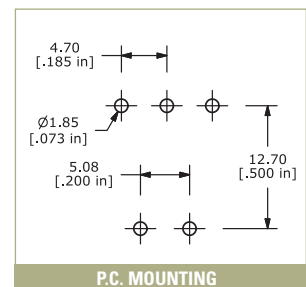
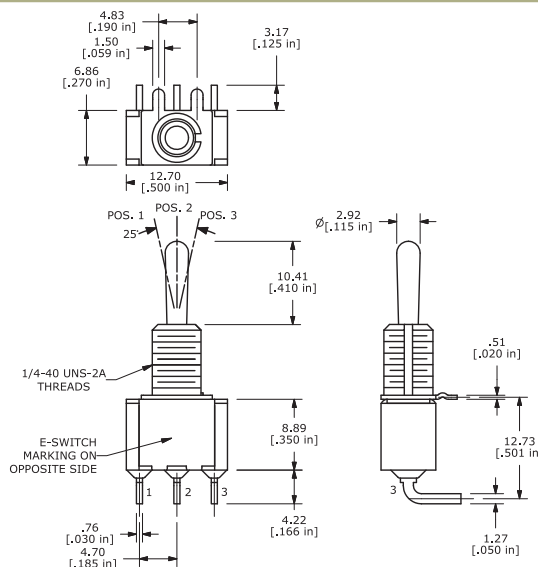



M61

DPDT

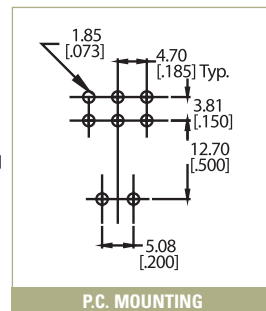
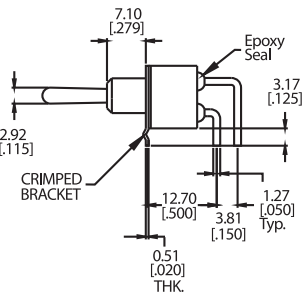
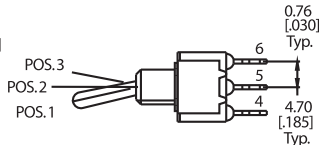
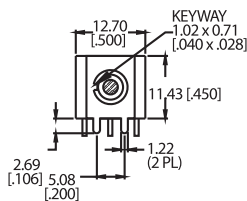

P.C. MOUNTING

M71

SPDT

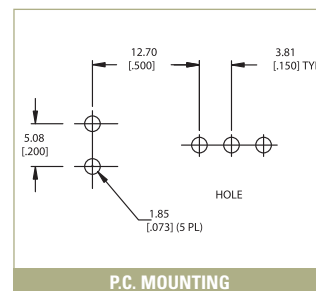
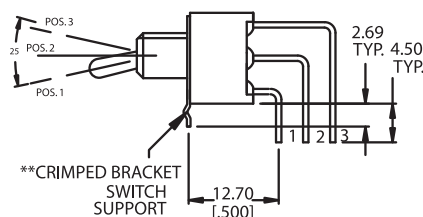
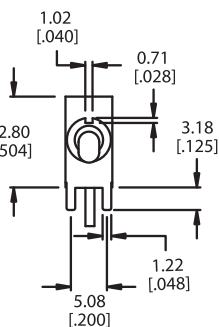

P.C. MOUNTING

M64

SPDT

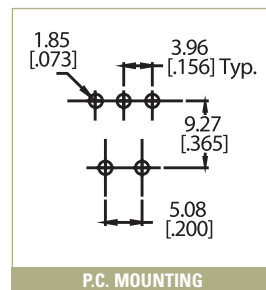
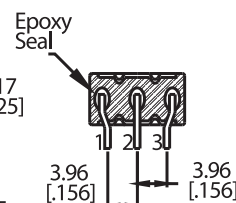
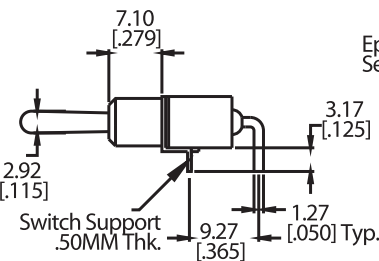
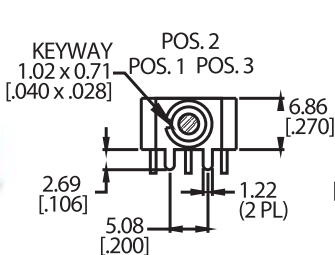

P.C. MOUNTING

TACT SWITCHES

NAVIGATION SWITCHES

PUSHBUTTON SWITCHES

TOGGLE SWITCHES

ROCKER SWITCHES

SLIDE SWITCHES

SNAP-ACTION SWITCHES

DIP SWITCHES

KEYLOCK SWITCHES

ROTARY SWITCHES

DETECTOR SWITCHES

CAP OPTIONS

SERIES 100 SWITCHES

TOGGLE SWITCHES - MINIATURE

VS21-VS31

SPDT

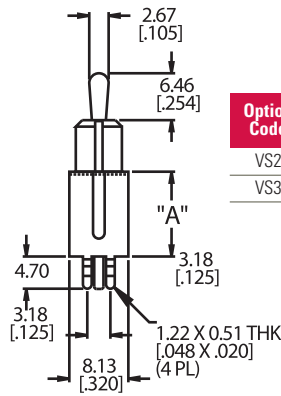
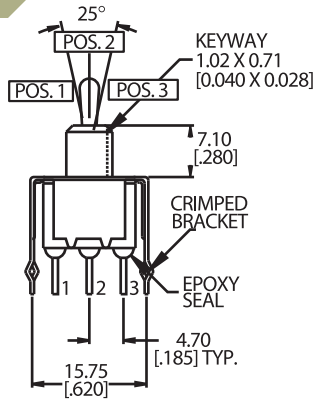

| Option Code | Dim. 'A' |
|-------------|--------------|
| VS2 | .460 (11.68) |
| VS3 | .630 (16.00) |

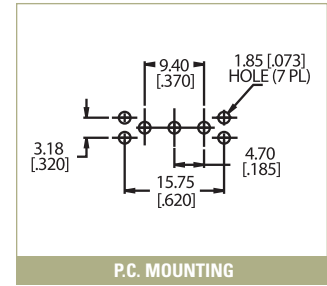

P.C. MOUNTING

VS21-VS31

DPDT

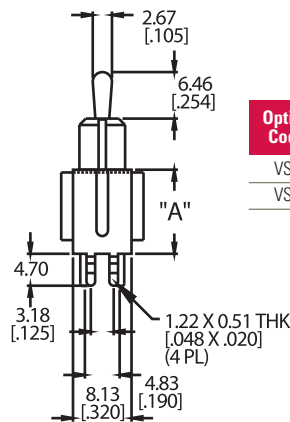
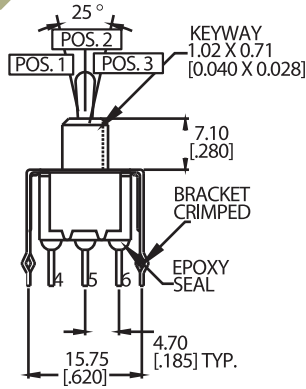

| Option Code | Dim. 'A' |
|-------------|--------------|
| VS2 | .460 (11.68) |
| VS3 | .630 (16.00) |

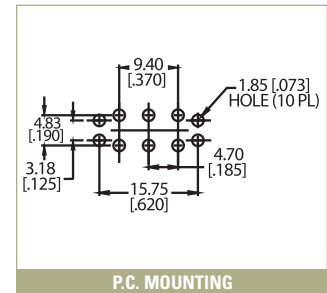

P.C. MOUNTING

OPTIONAL TOGGLE CAP



Use with T1
T100-1 WHITE
T100-2 BLACK

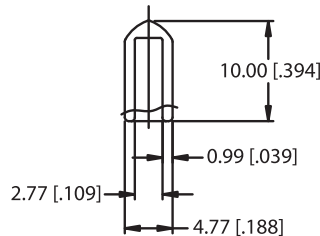

CONTACT MATERIAL OPTIONS

Q

| | |
|-----------------|--|
| Fixed Terminal: | Silver plated over copper alloy |
| Moving Contact: | Silver plated over copper alloy |
| Rating: | 5 Amps with resistive load @ 120VAC or 28VDC; 2 Amps with resistive load @ 250VAC |

R

| | |
|-----------------|--|
| Fixed Terminal: | Copper alloy with gold plate over nickel plate |
| Moving Contact: | Copper alloy with gold plate over nickel plate |
| Rating: | 0.4 Volt-Amps (VA) max. @ 20V max. (AC or DC) |



HARDWARE

HDW2 1/4 IN. NUTS

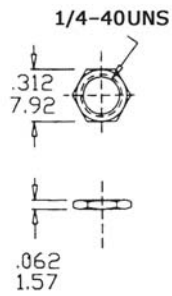

Supplied standard with B1, B3, B5, B6 and B9 options

HDW3 BLIND DRESSNUT

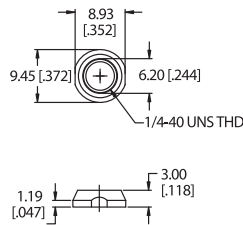

HDW6 METRIC NUT

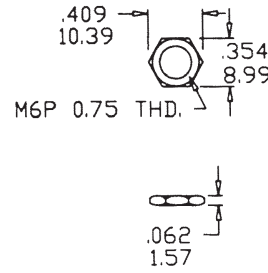

Supplied standard with B8 metric bushing

HDW11 LOCK WASHER

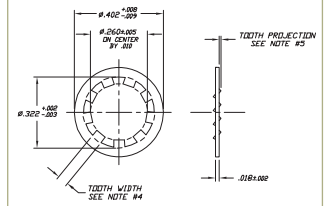

Supplied standard with B1/B3 bushing

Optional Rubber Hood Sealing E1

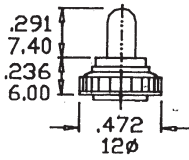

E1= Inch (Std.) for actuator T1, T2 and bushings B1, B3, B5, B6 Optional rubber boot sealing

HDW4 15/32 IN. NUTS

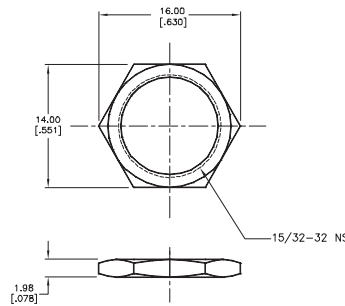

Supplied standard with B13 bushing

HDW12 LOCK WASHER

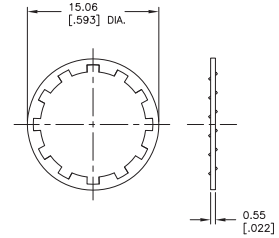

Supplied standard with B13 bushing

HDW15 LOCKING RING

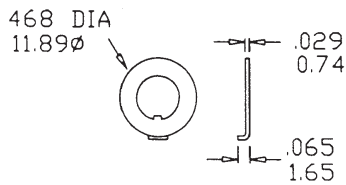

Supplied standard

HDW16 LOCKING RING

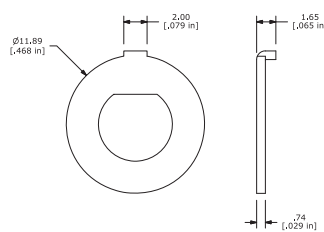

Supplied with B5 bushing

HDW17 LOCKING RING

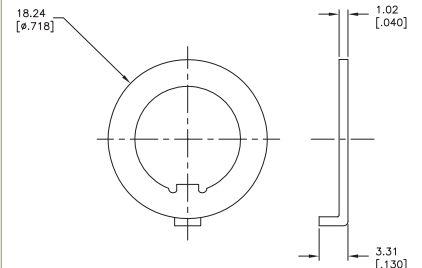

Supplied with B13 bushing

TACT SWITCHES

NAVIGATION SWITCHES

PUSHBUTTON SWITCHES

TOGGLE SWITCHES

ROCKER SWITCHES

SLIDE SWITCHES

SNAP-ACTION SWITCHES

DIP SWITCHES

KEYLOCK SWITCHES

ROTARY SWITCHES

DETECTOR SWITCHES

CAP OPTIONS