

Restricted to: General Release

1905492

Part No

THIS DRAWING IS A CONTROLLED DOCUMENT.

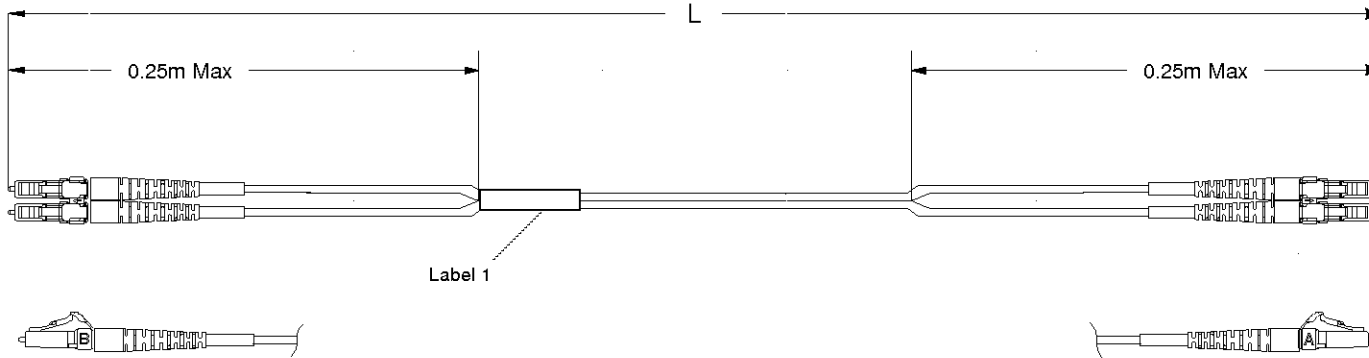

Connector(s): LC-Duplex Secure
 Mode: SM
 Housing Color: Green
 Geom. Spec: N/A

Number of Fibers: 2
 Mode: SM
 Jacket Diameter: 1.8 mm
 Jacket Color: Yellow
 FiberType: SM

Connector(s): LC-Duplex
 Mode: SM
 Housing Color: Blue
 Geom. Spec: N/A

A - - B
 B - - A

LC strain relief - 1.6 to 2.0 mm cable
 Color: Blue/Blue

LC strain relief - 1.6 to 2.0 mm cable
 Color: Blue/Blue

Notes:

- 1 Product and Processing must meet requirements of Tyco Electronics Standard 230-702
- 2 Includes dust caps (not shown on print).

3 **OBsolete PARTS: OBsolete CIS STREAMLINING PER D.RENAUD/D.SINISI**

THIS INFORMATION IS CONFIDENTIAL AND PROPRIETARY TO TYCO ELECTRONICS CORPORATION. IT IS TO BE USED ONLY BY THE PERSONNEL AND ELECTRONICS PERSONNEL TO WHOM IT IS ISSUED. IT IS NOT TO BE REPRODUCED OR TRANSMITTED IN ANY FORM OR BY ANY MEANS, ELECTRONIC OR MECHANICAL, INCLUDING PHOTOCOPYING, RECORDING, OR BY ANY INFORMATION STORAGE AND RETRIEVAL SYSTEM, WITHOUT WRITTEN AUTHORIZATION FROM TYCO ELECTRONICS CORPORATION, HARRISBURG, PENNSYLVANIA.

LOC
 CE
 DIST
 16

A1		REV PER ECO-10-000030	05JAN10	KK	AEG
A	Rev Per EC#	RELEASE	3/10/2006		
P	LTR	REVISION RECORD	DATE	DN	APVD

DIMENSIONS:	TOLERANCES UNLESS OTHERWISE SPECIFIED:
mm/ths	
0 PLC	± .
1 PLC	± .
2 PLC	± .
3 PLC	± .
4 PLC	± .

Customer Print

DIN	Cable Assy Configurator	MATERIAL	HEAT TREAT
DNK	Cable Assy Configurator		
APVD	Refer to Engineering Change		
NAME	FO C/A - 2 fiber, 1.8mm, SM, OFNP (Plenum) jacket, LC-Duplex Secure to LC-Duplex		
SCALE	SIZE	DRAWING NO	SHEET
NTS	A2	C- 1905492	1 of 4
			REV
			A1

THIS DRAWING IS A CONTROLLED DOCUMENT.





Part #	L (meters)	LC-Duplex Secure, Green		LC-Duplex, Blue	
		IL (dB)	RL (dB)	IL (dB)	RL (dB)
0-1905492-1	0.950 - 1.050	0.50	45	0.50	45
0-1905492-2	1.950 - 2.050	0.50	45	0.50	45
0-1905492-3	2.950 - 3.050	0.50	45	0.50	45
0-1905492-4	3.920 - 4.080	0.51	45	0.51	45
0-1905492-5	4.920 - 5.080	0.51	45	0.51	45
0-1905492-6	5.920 - 6.080	0.51	45	0.51	45
0-1905492-7	6.920 - 7.080	0.51	45	0.51	45
0-1905492-8	7.920 - 8.080	0.51	45	0.51	45
0-1905492-9	8.850 - 9.150	0.51	45	0.51	45
1-1905492-0	9.850 - 10.150	0.52	45	0.52	45
1-1905492-1	10.850 - 11.150	0.52	45	0.52	45
1-1905492-2	11.850 - 12.150	0.52	45	0.52	45
1-1905492-3	12.850 - 13.150	0.52	45	0.52	45
1-1905492-4	13.850 - 14.150	0.52	45	0.52	45
1-1905492-5	14.850 - 15.150	0.52	45	0.52	45
1-1905492-6	15.840 - 16.160	0.52	45	0.52	45
1-1905492-7	16.830 - 17.170	0.53	45	0.53	45
1-1905492-8	17.820 - 18.180	0.53	45	0.53	45
1-1905492-9	18.810 - 19.190	0.53	45	0.53	45
2-1905492-0	19.800 - 20.200	0.53	45	0.53	45
2-1905492-1	20.790 - 21.210	0.53	45	0.53	45
2-1905492-2	21.780 - 22.220	0.53	45	0.53	45
2-1905492-3	22.770 - 23.230	0.53	45	0.53	45
2-1905492-4	23.760 - 24.240	0.54	45	0.54	45
2-1905492-5	24.750 - 25.250	0.54	45	0.54	45
2-1905492-6	25.740 - 26.260	0.54	45	0.54	45
2-1905492-7	26.730 - 27.270	0.54	45	0.54	45
2-1905492-8	27.720 - 28.280	0.54	45	0.54	45
2-1905492-9	28.710 - 29.290	0.54	45	0.54	45
3-1905492-0	29.700 - 30.300	0.55	45	0.55	45
3-1905492-1	30.690 - 31.310	0.55	45	0.55	45
3-1905492-2	31.680 - 32.320	0.55	45	0.55	45
3-1905492-3	32.670 - 33.330	0.55	45	0.55	45
3-1905492-4	33.660 - 34.340	0.55	45	0.55	45
3-1905492-5	34.650 - 35.350	0.55	45	0.55	45
3-1905492-6	35.640 - 36.360	0.55	45	0.55	45
3-1905492-7	36.630 - 37.370	0.56	45	0.56	45
3-1905492-8	37.620 - 38.380	0.56	45	0.56	45
3-1905492-9	38.610 - 39.390	0.56	45	0.56	45
4-1905492-0	39.600 - 40.400	0.56	45	0.56	45
4-1905492-1	40.590 - 41.410	0.56	45	0.56	45
4-1905492-2	41.580 - 42.420	0.56	45	0.56	45
4-1905492-3	42.570 - 43.430	0.56	45	0.56	45
4-1905492-4	43.560 - 44.440	0.57	45	0.57	45

OBSOLETE 

THIS INFORMATION IS CONFIDENTIAL AND PROPRIETARY TO TICO ELECTRONICS CORPORATION. IT IS THE PROPERTY OF TICO ELECTRONICS CORPORATION AND IS TO BE USED ONLY BY THE PERSONNEL TO WHOM IT IS ISSUED. IT IS NOT TO BE REPRODUCED, COPIED, OR TRANSMITTED IN ANY FORM OR BY ANY MEANS, WITHOUT WRITTEN AUTHORIZATION FROM TICO ELECTRONICS CORPORATION, HARRISBURG, PENNSYLVANIA

LOC
CE
DIST
16

SEE SHEET 1					
A	Rev Per	EC#	RELEASE	3/10/2006	
P	LTR	REVISION	RECORD	DATE	DNV APVD

DIMENSIONS:	TOLERANCES UNLESS OTHERWISE SPECIFIED:
mm/In	
	0 PLC ± .1
	1 PLC ± .1
	2 PLC ± .1
	3 PLC ± .1
	4 PLC ± .1

DIN	Cable Assy Configurator	MATERIAL	HEAT TREAT
DNK	Cable Assy Configurator	AMP Tyco Electronics, Inc. Harrisburg, PA 17105-3808	
APVD	Refer to Engineering Change		
NAME	FO C/A - 2 fiber, 1.8mm, SM, OFNP (Plenum) jacket, LC-Duplex Secure to LC-Duplex		
SCALE	SIZE	DRAWING NO	SHEET
NTS	A2	C- 1905492	2 of 4
			REV A1

Customer Print

THIS DRAWING IS A CONTROLLED DOCUMENT.

Part #	L (meters)	LC-Duplex Secure, Green		LC-Duplex, Blue	
		IL (dB)	RL (dB)	IL (dB)	RL (dB)
4-1905492-5	44.550 - 46.450	0.57	45	0.57	45
4-1905492-6	45.540 - 46.460	0.57	45	0.57	45
4-1905492-7	46.530 - 47.470	0.57	45	0.57	45
4-1905492-8	47.520 - 48.480	0.57	45	0.57	45
4-1905492-9	48.510 - 49.490	0.57	45	0.57	45
5-1905492-0	49.500 - 50.500	0.58	45	0.58	45
5-1905492-1	50.490 - 51.510	0.58	45	0.58	45
5-1905492-2	51.480 - 52.520	0.58	45	0.58	45
5-1905492-3	52.470 - 53.530	0.58	45	0.58	45
5-1905492-4	53.460 - 54.540	0.58	45	0.58	45
5-1905492-5	54.450 - 55.550	0.58	45	0.58	45
5-1905492-6	55.440 - 56.560	0.58	45	0.58	45
5-1905492-7	56.430 - 57.570	0.59	45	0.59	45
5-1905492-8	57.420 - 58.580	0.59	45	0.59	45
5-1905492-9	58.410 - 59.590	0.59	45	0.59	45
6-1905492-0	59.400 - 60.600	0.59	45	0.59	45
6-1905492-1	60.390 - 61.610	0.59	45	0.59	45
6-1905492-2	61.380 - 62.620	0.59	45	0.59	45
6-1905492-3	62.370 - 63.630	0.59	45	0.59	45
6-1905492-4	63.360 - 64.640	0.60	45	0.60	45
6-1905492-5	64.350 - 65.650	0.60	45	0.60	45
6-1905492-6	65.340 - 66.660	0.60	45	0.60	45
6-1905492-7	66.330 - 67.670	0.60	45	0.60	45
6-1905492-8	67.320 - 68.680	0.60	45	0.60	45
6-1905492-9	68.310 - 69.690	0.60	45	0.60	45
7-1905492-0	69.300 - 70.700	0.61	45	0.61	45
7-1905492-1	70.290 - 71.710	0.61	45	0.61	45
7-1905492-2	71.280 - 72.720	0.61	45	0.61	45
7-1905492-3	72.270 - 73.730	0.61	45	0.61	45
7-1905492-4	73.260 - 74.740	0.61	45	0.61	45
7-1905492-5	74.250 - 75.750	0.61	45	0.61	45
7-1905492-6	75.240 - 76.760	0.61	45	0.61	45
7-1905492-7	76.230 - 77.770	0.62	45	0.62	45
7-1905492-8	77.220 - 78.780	0.62	45	0.62	45
7-1905492-9	78.210 - 79.790	0.62	45	0.62	45
8-1905492-0	79.200 - 80.800	0.62	45	0.62	45

THIS INFORMATION IS CONFIDENTIAL AND PROPRIETARY TO TICO ELECTRONICS CORPORATION. IT IS TO BE KEPT CONFIDENTIAL AND NOT TO BE DISCLOSED TO ANY OTHER PERSONS OR ORGANIZATIONS WITHOUT WRITTEN AUTHORIZATION FROM TICO ELECTRONICS CORPORATION, HARRISBURG, PENNSYLVANIA.

LOC
CE
DIST
16

SEE SHEET 1		3/10/2006	-	-	-	
						Rev Per EC#
P	L/R	REVISION RECORD		DATE	DN	APVD

DIMENSIONS: mm/inches
TOLERANCES UNLESS OTHERWISE SPECIFIED:

0 PLG ± .
1 PLG ± .
2 PLG ± .
3 PLG ± .
4 PLG ± .



Customer Print

DWG	Cable Assy Configurator	MATERIAL	HEAT TREAT
DWG	Cable Assy Configurator	 Tico Electronics, Inc. Harrisburg, PA 17105-3608	
APVD	Refer to Engineering Change		
NAME	FO C/A - 2 fiber, 1.8mm, SM, OFNP (Plenum) jacket, LC-Duplex Secure to LC-Duplex		
SCALE	SIZE	DRAWING NO	SHEET
NTS	A2	C-1905492	3 of 4
			REV A1

8

7

6

5

4

3

2

1

D

C

B

A

Label 1

Per specification 107-1645-1



Trace # - Bar Code

Trace # - Human Readable

Part Number

Country of Origin

This label is used on all lengths on this drawing.

THIS DRAWING IS A CONTROLLED DOCUMENT.

THIS INFORMATION IS CONFIDENTIAL AND PROPRIETARY TO TYCO ELECTRONICS CORPORATION. IT IS NOT TO BE DISCLOSED TO ANY OTHER PERSON OR ENTITY WITHOUT THE WRITTEN AUTHORIZATION OF TYCO ELECTRONICS CORPORATION, HARRISBURG, PENNSYLVANIA.

LOC
CE
DIST
16

SEE SHEET 1						
A	Rev Per EC#	RELEASE	3/10/2006			
P	LTR	REVISION RECORD	DATE	DWN	APVD	

DIMENSIONS: mm/in	TOLERANCES UNLESS OTHERWISE SPECIFIED:
	0 PLC ± .
	1 PLC ± .
	2 PLC ± .
	3 PLC ± .
	4 PLC ± .

DWN	Cable Assy Configurator	MATERIAL	HEAT TREAT	
DWN	Cable Assy Configurator	Tyco Electronics, Inc. Harrisburg, PA 17105-3608		
APVD	Refer to Engineering Change			
NAME	FO C/A - 2 fiber, 1.8mm, SM, OFNP (Plenum) jacket, LC-Duplex Secure to LC-Duplex			
SCALE	SIZE	DRAWING NO	SHEET	REV
NTS	A2	C- 1905492	4 of 4	A1

Customer Print