

13 12 11 10 9 8 7 6 5 4 3 2 1

J I H G F E D C B A

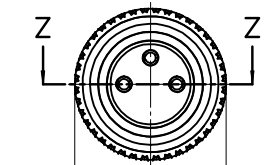
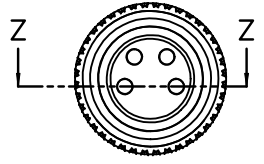
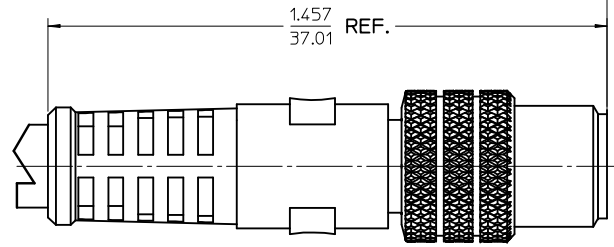
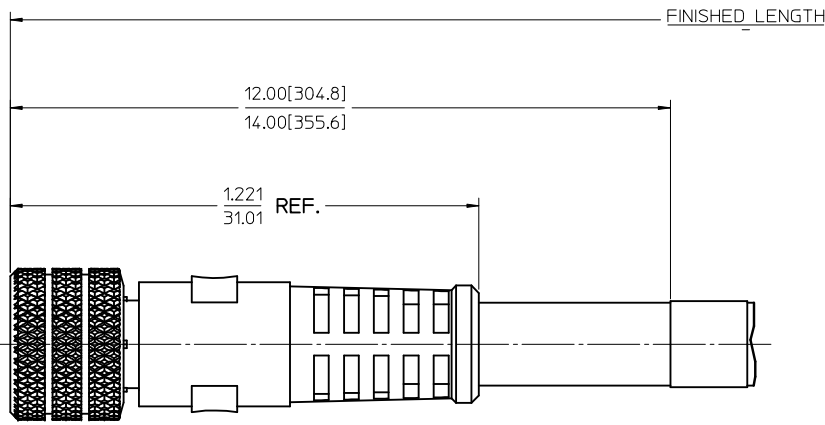
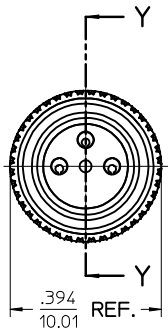

ENTER DESCRIPTION EC NO: WEU2010-0019 DRWN: LSC 2009/07/16 CHKD: JPMURPHY 2009/08/10 APPR: JPMURPHY REV: A	QUALITY SYMBOLS ▽=0 ▽=0	GENERAL TOLERANCES (UNLESS SPECIFIED) <table border="1"> <tr> <td></td> <td>mm</td> <td>INCH</td> </tr> <tr> <td>4 PLACES</td> <td>± .005</td> <td>± .0004</td> </tr> <tr> <td>3 PLACES</td> <td>± .004</td> <td>± .0003</td> </tr> <tr> <td>2 PLACES</td> <td>± .003</td> <td>± .0002</td> </tr> <tr> <td>1 PLACE</td> <td>± .002</td> <td>± .0001</td> </tr> </table>		mm	INCH	4 PLACES	± .005	± .0004	3 PLACES	± .004	± .0003	2 PLACES	± .003	± .0002	1 PLACE	± .002	± .0001	DIMENSION STYLE IN/MM DRAWN BY: NKUMAR01 DATE: 16/07/09 CHECKED BY: BWOODMAN DATE: 16/07/09 APPROVED BY: JFMURPHY DATE: 16/07/09	SCALE: 4:1 DESIGN UNITS: INCH THIRD ANGLE PROJECTION
		mm	INCH																
	4 PLACES	± .005	± .0004																
	3 PLACES	± .004	± .0003																
2 PLACES	± .003	± .0002																	
1 PLACE	± .002	± .0001																	
DRAFT WHERE APPLICABLE MUST REMAIN WITHIN DIMENSIONS	MATERIAL NO. SEE SHEET 3	TITLE NC 4P M/MFE 0.6M ST/ST CPLR 24	MOLEX INCORPORATED	SHEET NO. 1 OF 3															
THIS DRAWING CONTAINS INFORMATION THAT IS PROPRIETARY TO MOLEX INCORPORATED AND SHOULD NOT BE USED WITHOUT WRITTEN PERMISSION	SIZE: C	DOCUMENT NO. SD-120087-092																	

1b_frame_C_P_AM_T Rev. E 2006/04/15 12 11 10 9 8 7 6 5 4 3 2 1

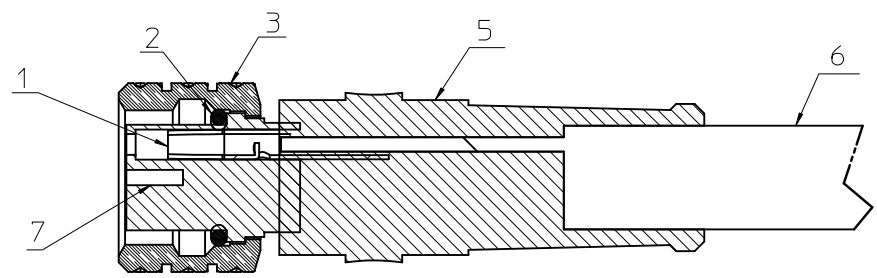
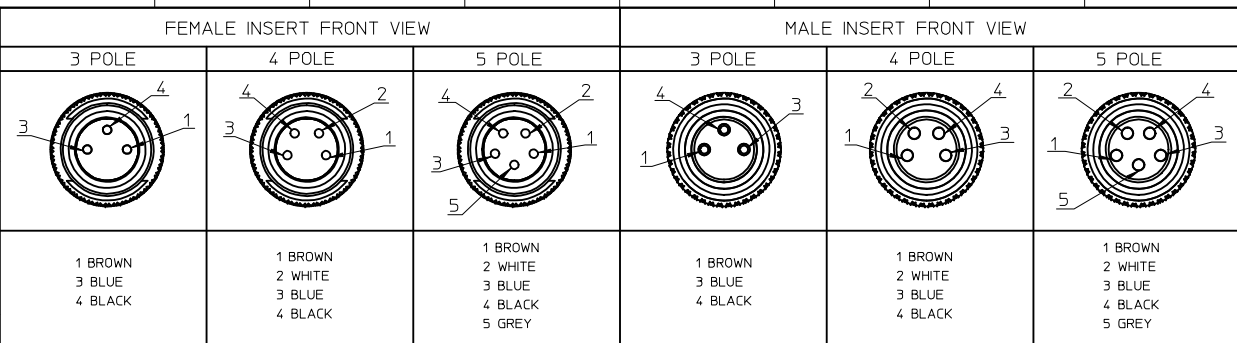

SEC Y-Y

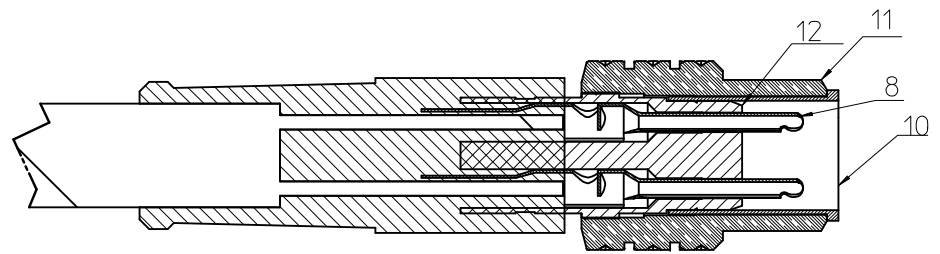

SEC Z-Z

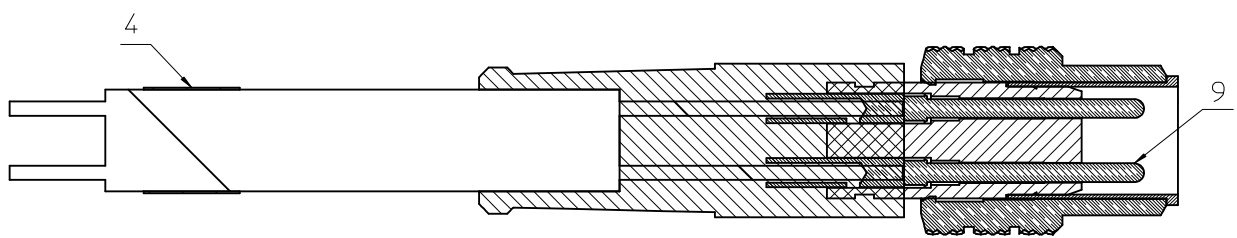

SECTION Z-Z
FOR 4-5 PLOE ONLY
[4 POLE SHOWN]

ENTER DESCRIPTION EC NO: WEU2010-0019 DRAWN: SG CHKD: JF APPR: JF MURPHY 2009/07/16 2009/08/10	QUALITY SYMBOLS 	GENERAL TOLERANCES (UNLESS SPECIFIED)		DIMENSION STYLE IN/MM	SCALE 5:1	DESIGN UNITS INCH	THIRD ANGLE PROJECTION
		4 PLACES ± --- ± --- 3 PLACES ± --- ± --- 2 PLACES ± --- ± --- 1 PLACE ± --- ± ---	mm INCH	DRAWN BY: NKUMAR01 DATE: 16/07/09 CHECKED BY: BWOODMAN DATE: 16/07/09 APPROVED BY: JFMURPHY DATE: 16/07/09	TITLE NC 4P M/MFE 0.6M ST/ST CPLR 24		
		ANGULAR ±1/2°		MATERIAL NO. SEE SHEET 3	DOCUMENT NO. SD-120087-092	SHEET NO. 2 OF 3	
		DRAFT WHERE APPLICABLE MUST REMAIN WITHIN DIMENSIONS		THIS DRAWING CONTAINS INFORMATION THAT IS PROPRIETARY TO MOLEX INCORPORATED AND SHOULD NOT BE USED WITHOUT WRITTEN PERMISSION			

J
I
H
G
F
E
D
C
B
A

SL.No	DESCRIPTION	MATERIAL	FINISH	FEMALE INSERT ASSEMBLY			MALE INSERT ASSEMBLY		
				3 POLE	4 POLE	5 POLE	3 POLE	4 POLE	5 POLE
				QTY			QTY		
1	CONTACT SOCKET	COPPER ALLOY	GOLD PLATED	3	4	5			
2	O-RING	VITON	RED	1	1	1			
3	COUPLING NUT	BRASS	NICKEL PLATED						
4	LABEL	PLASTIC FILM	BLACK/YELLOW	1	1	1	1	1	1
5	OVER MOLD	TPE	YELLOW						
6	CABLE, 24 AWG, 3 CONDUCTOR	PVC JACKET	YELLOW	1			1		
	CABLE, 24 AWG, 4 CONDUCTOR	PVC JACKET	YELLOW		1			1	
	CABLE, 24 AWG, 5 CONDUCTOR	PVC JACKET	YELLOW			1			1
7	INSERT FEMALE 3 POLE	PUR	BLACK	1					
	INSERT FEMALE 4 POLE	PUR	BLACK		1				
	INSERT FEMALE 5 POLE	PUR	BLACK			1			
8	STAMP & FORM CONTACT	COPPER ALLOY	GOLD PLATED				3		
9	SCREW MACHINE CONTACT	COPPER ALLOY	GOLD PLATED					4	5
10	SLEEVE	BRASS	NICKEL PLATED				1	1	1
11	COUPLING NUT	BRASS	NICKEL PLATED				1	1	1
12	INSERT MALE 3 POLE	PUR	BLACK				1		
	INSERT MALE 4 POLE	PUR	BLACK					1	
	INSERT MALE 5 POLE	PUR	BLACK						1

PART NUMBER	DESCRIPTION	FINISHED LENGTH
1200870071	443030A10M006	0.6M +45MM -0 [1' 11" +1.8" -0]
1200870074	443030A10M010	1M +56MM -0 [3' 3" +2.2" -0]
1200870078	443030A10M020	2M +90MM -0 [6' 6" +3.5" -0]
1200870079	443030A10M030	3M +90MM -0 [9' 10" +3.5" -0]
1200870080	443030A10M040	4M +150MM -0 [13' 1" +6" -0]
1200870081	443030A10M050	5M +150MM -0 [16' 4" +6" -0]
1200870092	444030A10M006	0.6M +45MM -0 [1' 11" +1.8" -0]
1200870093	444030A10M010	1M +56MM -0 [3' 3" +2.2" -0]
1200870095	444030A10M020	2M +90MM -0 [6' 6" +3.5" -0]
1200870096	444030A10M030	3M +90MM -0 [9' 10" +3.5" -0]
1200870097	444030A10M040	4M +150MM -0 [13' 1" +6" -0]
1200870098	444030A10M050	5M +150MM -0 [16' 4" +6" -0]
1200870677	445030A10M006	0.6M +45MM -0 [1' 11" +1.8" -0]
1200870112	445030A10M010	1M +56MM -0 [3' 3" +2.2" -0]
1200870113	445030A10M020	2M +90MM -0 [6' 6" +3.5" -0]
1200870678	445030A10M030	3M +90MM -0 [9' 10" +3.5" -0]
1200870114	445030A10M040	4M +150MM -0 [13' 1" +6" -0]
1200870041	445030A10M050	5M +150MM -0 [16' 4" +6" -0]

ENTER DESCRIPTION EC NO: WEU2010-0019 DRAWN/SG: 2009/07/16 CHKD: JFMURPHY APPR: JFMURPHY 2009/08/10 DESCRIPTION REV: A	QUALITY SYMBOLS ▽=0 ▽=0	GENERAL TOLERANCES (UNLESS SPECIFIED)		DIMENSION STYLE IN/MM		SCALE 5:1	DESIGN UNITS INCH	THIRD ANGLE PROJECTION	
		4 PLACES ± --- ± --- 3 PLACES ± --- ± --- 2 PLACES ± --- ± --- 1 PLACE ± --- ± ---	mm INCH	DRAWN BY NKUMAR01	DATE 16/07/09	TITLE NC 4P M/MFE 0.6M ST/ST CPLR 24			
		ANGULAR ±1/2°		CHECKED BY BWOODMAN	DATE 16/07/09	MOLEX INCORPORATED			
		DRAFT WHERE APPLICABLE MUST REMAIN WITHIN DIMENSIONS		APPROVED BY JFMURPHY	DATE 16/07/09	SEE CHART		DOCUMENT NO. SD-120087-092	SHEET NO. 3 OF 3

THIS DRAWING CONTAINS INFORMATION THAT IS PROPRIETARY TO MOLEX INCORPORATED AND SHOULD NOT BE USED WITHOUT WRITTEN PERMISSION