

## ANNA-40-7-S

~15° spot beam with 7 optics

### TECHNICAL SPECIFICATIONS:

Dimensions	Ø 40.0 mm
Height	10.7 mm
Fastening	pin
Colour	clear
Box size	480 x 280 x 300 mm
Box weight	8.2 kg
Quantity in Box	760 pcs
ROHS compliant	yes ⓘ



### MATERIAL SPECIFICATIONS:

Component	Type	Material	Colour
ANNA-40-7-S	Lens array	PMMA	clear

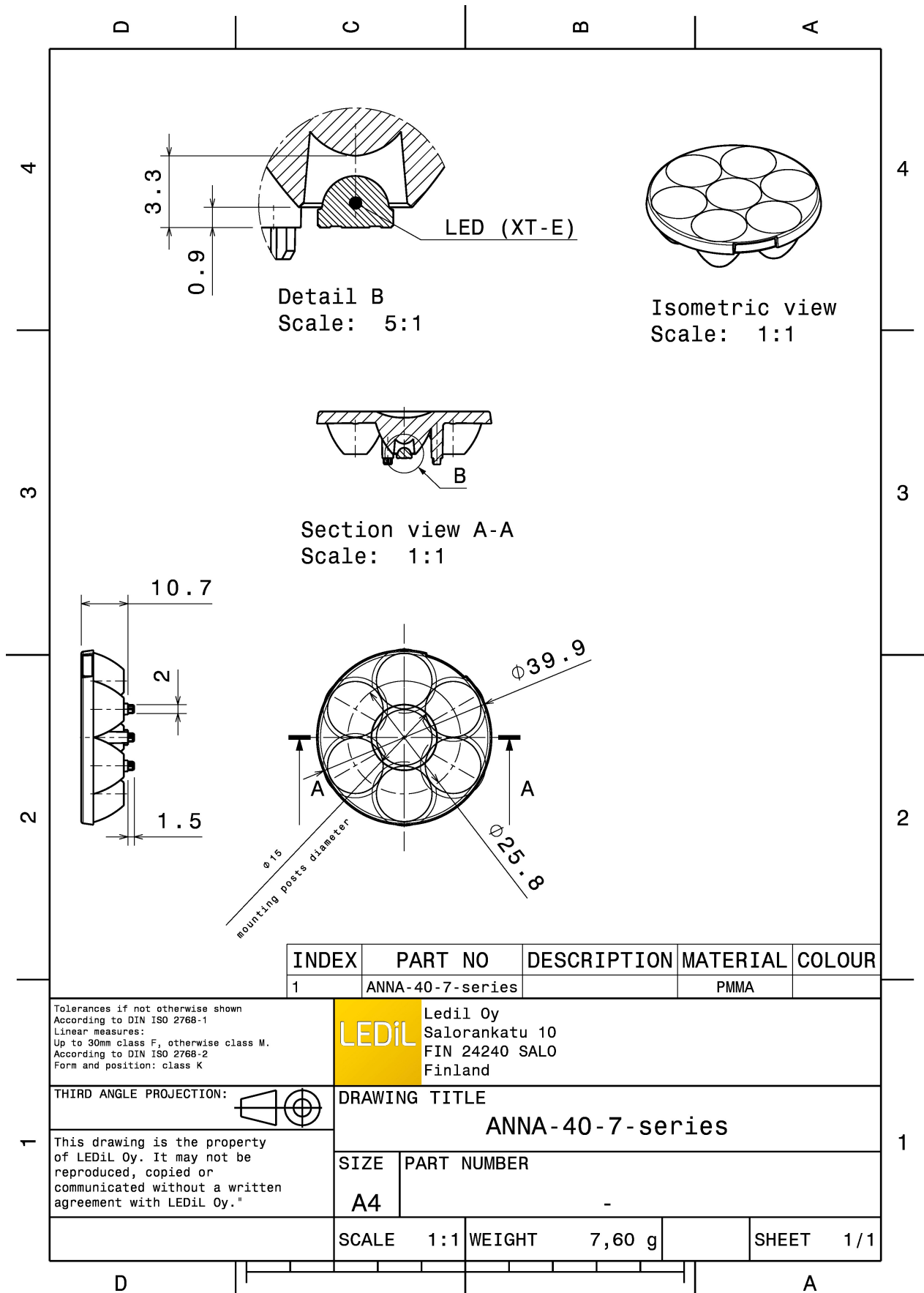

INDEX	PART NO	DESCRIPTION	MATERIAL	COLOUR
1	ANNA-40-7-series		PMMA	

Tolerances if not otherwise shown  
According to DIN ISO 2768-1  
Linear measures:  
Up to 30mm class F, otherwise class M.  
According to DIN ISO 2768-2  
Form and position: class K



Ledil Oy  
Salorankatu 10  
FIN 24240 SALO  
Finland

THIRD ANGLE PROJECTION:

DRAWING TITLE

**ANNA-40-7-series**

This drawing is the property of LEDiL Oy. It may not be reproduced, copied or communicated without a written agreement with LEDiL Oy."

SIZE PART NUMBER

A4

SCALE 1:1

WEIGHT 7,60 g

SHEET 1/1

### PHOTOMETRIC DATA (MEASURED):

**CREE** 

LED XP-E2  
FWHM 12.0°  
Efficiency 87 %  
Peak intensity 13.831 cd/lm  
Required components:

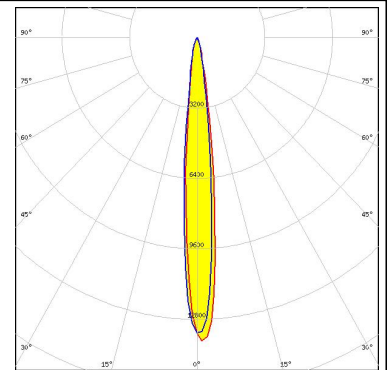

**CREE** 

LED XP-G2  
FWHM 17.0°  
Efficiency 91 %  
Peak intensity 7.600 cd/lm  
Required components:

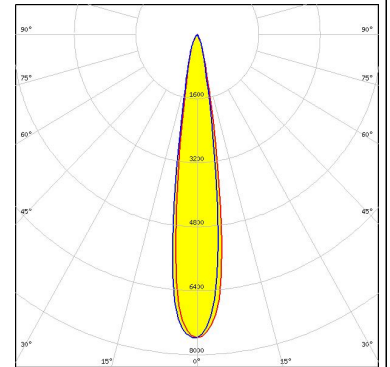

**CREE** 

LED XT-E  
FWHM 16.0°  
Efficiency 89 %  
Peak intensity 7.300 cd/lm  
Required components:

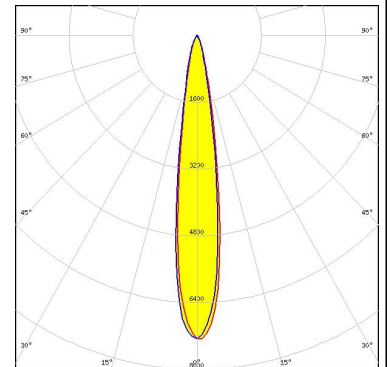

#### PHOTOMETRIC DATA (SIMULATED):

<p>bridgelux.</p> <p>LED SM4</p> <p>FWHM 33.0°</p> <p>Efficiency 87 %</p> <p>Peak intensity 2.104 cd/lm</p> <p>Required components:</p>	
<p><b>CREE</b> ⇄</p> <p>LED XB-D</p> <p>FWHM 13.0°</p> <p>Efficiency 90 %</p> <p>Peak intensity 12.030 cd/lm</p> <p>Required components:</p>	
<p><b>CREE</b> ⇄</p> <p>LED XP-E</p> <p>FWHM 11.0°</p> <p>Efficiency 93 %</p> <p>Peak intensity 17.390 cd/lm</p> <p>Required components:</p>	
<p><b>CREE</b> ⇄</p> <p>LED XP-G</p> <p>FWHM 15.0°</p> <p>Efficiency 93 %</p> <p>Peak intensity 9.337 cd/lm</p> <p>Required components:</p>	

#### PHOTOMETRIC DATA (SIMULATED):



LED XP-L  
 FWHM 22.0°  
 Efficiency 92 %  
 Peak intensity 4.370 cd/lm  
 Required components:

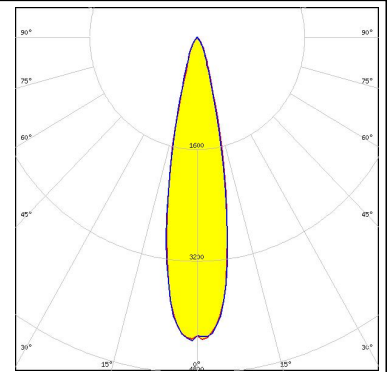

LED H35C0 (LEMWA33)  
 FWHM 16.0°  
 Efficiency 92 %  
 Peak intensity 7.270 cd/lm  
 Required components:

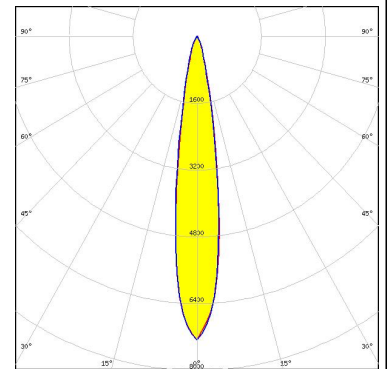

LED LUXEON PWT  
 FWHM 17.0°  
 Efficiency 88 %  
 Peak intensity 7.630 cd/lm  
 Required components:

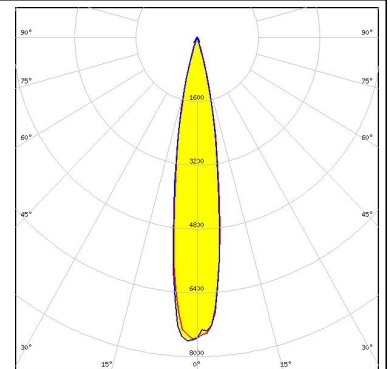

LED LUXEON T  
 FWHM 17.0°  
 Efficiency 92 %  
 Peak intensity 8.467 cd/lm  
 Required components:

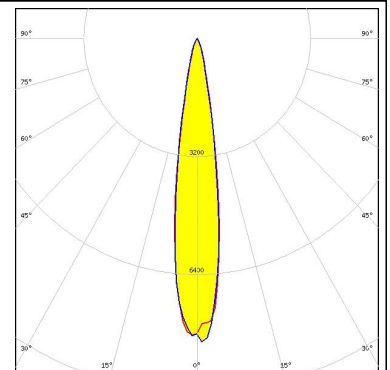

### PHOTOMETRIC DATA (SIMULATED):

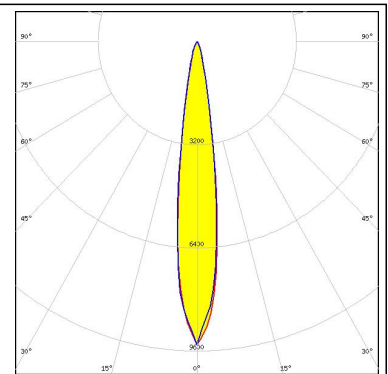
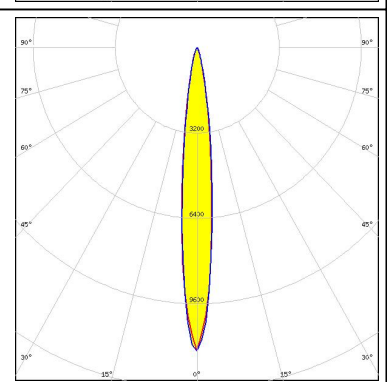
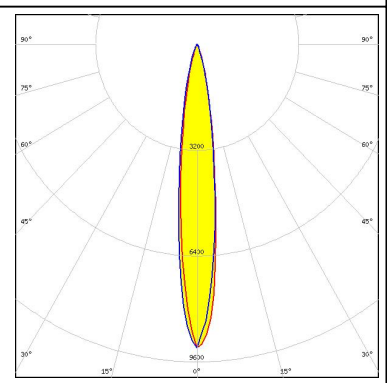
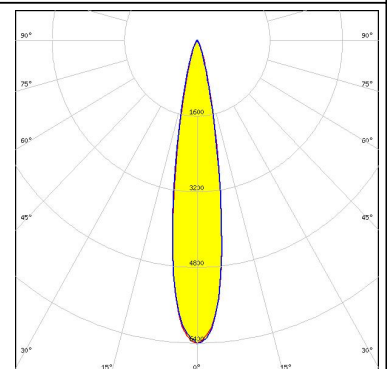
<p><b>LUMILEDS</b></p> <p>LED LUXEON TX FWHM 15.0° Efficiency 93 % Peak intensity 9.400 cd/lm Required components:</p>	
<p><b>NICHIA</b></p> <p>LED NCSxx19A FWHM 17.0° Efficiency 87 % Peak intensity 7.748 cd/lm Required components:</p>	
<p><b>NICHIA</b></p> <p>LED NF2x757A FWHM 14.0° Efficiency 92 % Peak intensity 9.180 cd/lm Required components:</p>	
<p><b>NICHIA</b></p> <p>LED NVSxx19B/NVSxx19C FWHM 18.0° Efficiency 92 % Peak intensity 6.270 cd/lm Required components:</p>	

**PHOTOMETRIC DATA (SIMULATED):**

**OSRAM**  
Opto Semiconductors

LED Oslon Square EC  
FWHM 13.0°  
Efficiency 92 %  
Peak intensity 11.210 cd/lm  
Required components:

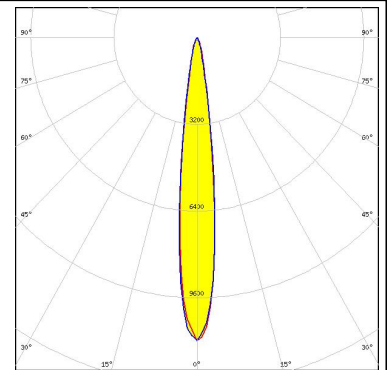

**OSRAM**  
Opto Semiconductors

LED Oslon SSL 150  
FWHM 10.0°  
Efficiency 92 %  
Peak intensity 19.840 cd/lm  
Required components:

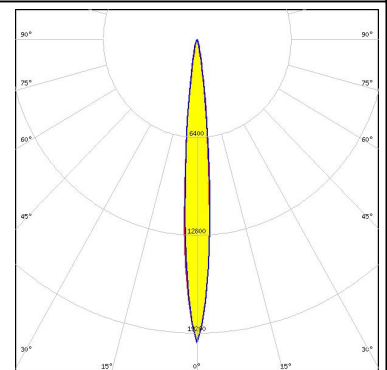

**OSRAM**  
Opto Semiconductors

LED Oslon SSL 80  
FWHM 8.0°  
Efficiency %  
Peak intensity 21.130 cd/lm  
Required components:

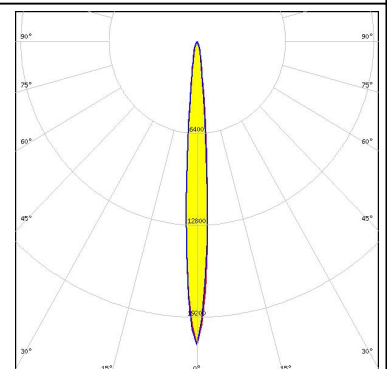

**OSRAM**  
Opto Semiconductors

LED SFH 4715S  
FWHM 13.0°  
Efficiency 90 %  
Peak intensity 11.690 cd/lm  
Required components:

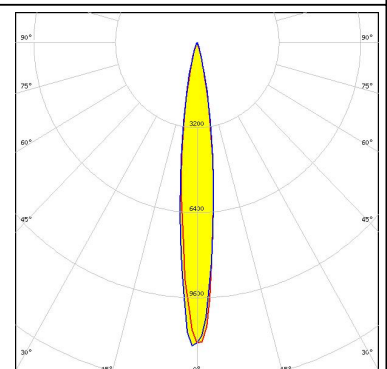

### PHOTOMETRIC DATA (SIMULATED):

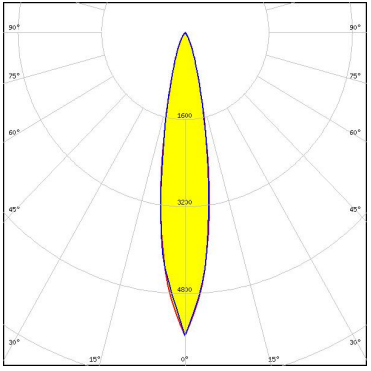
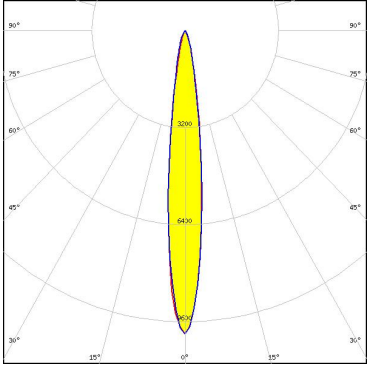
 SEOUL SEMICONDUCTOR		
LED	Z8Y22P	
FWHM	18.0°	
Efficiency	90 %	
Peak intensity	5.500 cd/m	
Required components:		
<b>SHARP</b>		
LED	Double Dome (GM2BB)	
FWHM	13.0°	
Efficiency	89 %	
Peak intensity	10.000 cd/m	
Required components:		



### GENERAL INFORMATION:

NOTE: The typical beam angle will be changed by different color, chip size and chip position tolerance. The typical total beam angle is the full angle measured where the luminous intensity is half of the peak value.

### MATERIALS:

As part of our continuous research and improvement processes, and to ensure the best possible quality and availability of our products, LEDiL reserves the right to change material grades without notice.

### PRODUCT DATA USER AGREEMENT AND DISCLAIMER:

The measured data in the provided downloadable LEDiL Product Datasheets and Mechanical 2D-Drawings is rounded and provided as reference for planning. LEDiL Oy's optical specifications have been verified by conducting performance testing of the products in accordance with the company's quality system. The reported data are averaged results of multiple measurements with typical variation. LEDiL Oy reserves the right to without prior notification make changes and improvements to its products.

LEDiL Oy assumes neither warranty, nor guarantee nor any other liability of any kind for the contents and correctness of the provided data. The provided data has been generated with highest diligence but the provided data may in reality not represent the complete possible variation range of all intrinsic parameters. Therefore, in certain cases a deviation from the provided data could occur.

LEDiL Oy reserves the right to undertake technical changes of its products without further notification which could lead to changes in the provided data. LEDiL Oy assumes no liability of any kind for the possible deviation from any provided data or any other damage resulting from the usage of the provided data.

The user agrees to this disclaimer and user agreement with the download or usage of the provided files.

#### LEDiL Oy

Joensuunkatu 13  
FI-24240 SALO  
Finland

#### LEDiL Inc.

228 West Page Street  
Suite D  
Sycamore IL 60178  
USA

#### Local sales and technical support

[www.ledil.com/  
where\\_to\\_buy](http://www.ledil.com/where_to_buy)

#### Shipping locations

Salo, Finland  
Hong Kong, China

#### Distribution Partners

[www.ledil.com/  
where\\_to\\_buy](http://www.ledil.com/where_to_buy)