

# Thyristor Module

<b>3~ Rectifier</b>	
$V_{RRM}$	= 1600
$I_{DAV}$	= 45
$I_{FSM}$	= 320

3~ Rectifier Bridge, half-controlled (high-side)

Part number

VVZ40-16io1

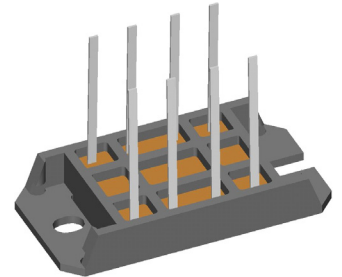

Backside: isolated

 E72873

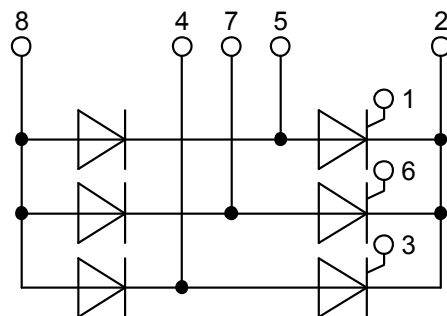

### Features / Advantages:

- Package with DCB ceramic base plate
- Improved temperature and power cycling
- Planar passivated chips
- Very low forward voltage drop
- Very low leakage current

### Applications:

- Line rectifying 50/60 Hz
- Drives
- SMPS
- UPS

### Package: V1-B-Pack

- Isolation Voltage: 3600 V~
- Industry standard outline
- RoHS compliant
- Soldering pins for PCB mounting
- Height: 17 mm
- Base plate: DCB ceramic
- Reduced weight
- Advanced power cycling

Rectifier				Ratings			
Symbol	Definition	Conditions	min.	typ.	max.	Unit	
$V_{RSM/DSM}$	max. non-repetitive reverse/forward blocking voltage	$T_{VJ} = 25^{\circ}C$			1700	V	
$V_{RRM/DRM}$	max. repetitive reverse/forward blocking voltage	$T_{VJ} = 25^{\circ}C$			1600	V	
$I_{RD}$	reverse current, drain current	$V_{R/D} = 1600 V$	$T_{VJ} = 25^{\circ}C$		300	$\mu A$	
		$V_{R/D} = 1600 V$	$T_{VJ} = 125^{\circ}C$		5	mA	
$V_T$	forward voltage drop	$I_T = 15 A$	$T_{VJ} = 25^{\circ}C$		1,12	V	
		$I_T = 45 A$			1,47	V	
		$I_T = 15 A$	$T_{VJ} = 125^{\circ}C$		1,07	V	
		$I_T = 45 A$			1,52	V	
$I_{DAV}$	bridge output current	$T_C = 100^{\circ}C$	$T_{VJ} = 125^{\circ}C$		45	A	
		rectangular $d = 1/3$					
$V_{TO}$	threshold voltage	} for power loss calculation only	$T_{VJ} = 125^{\circ}C$		0,85	V	
$r_T$	slope resistance				15	m $\Omega$	
$R_{thJC}$	thermal resistance junction to case				1	K/W	
$R_{thCH}$	thermal resistance case to heatsink			0,60		K/W	
$P_{tot}$	total power dissipation		$T_C = 25^{\circ}C$		100	W	
$I_{TSM}$	max. forward surge current	$t = 10 ms; (50 Hz), sine$	$T_{VJ} = 45^{\circ}C$		320	A	
		$t = 8,3 ms; (60 Hz), sine$	$V_R = 0 V$		345	A	
		$t = 10 ms; (50 Hz), sine$	$T_{VJ} = 125^{\circ}C$		270	A	
		$t = 8,3 ms; (60 Hz), sine$	$V_R = 0 V$		295	A	
$I^2t$	value for fusing	$t = 10 ms; (50 Hz), sine$	$T_{VJ} = 45^{\circ}C$		510	A <sup>2</sup> s	
		$t = 8,3 ms; (60 Hz), sine$	$V_R = 0 V$		495	A <sup>2</sup> s	
		$t = 10 ms; (50 Hz), sine$	$T_{VJ} = 125^{\circ}C$		365	A <sup>2</sup> s	
		$t = 8,3 ms; (60 Hz), sine$	$V_R = 0 V$		360	A <sup>2</sup> s	
$C_J$	junction capacitance	$V_R = 400 V \quad f = 1 MHz$	$T_{VJ} = 25^{\circ}C$		16	pF	
$P_{GM}$	max. gate power dissipation	$t_p = 30 \mu s$	$T_C = 125^{\circ}C$		10	W	
		$t_p = 300 \mu s$			1	W	
$P_{GAV}$	average gate power dissipation				0,5	W	
$(di/dt)_{cr}$	critical rate of rise of current	$T_{VJ} = 125^{\circ}C; f = 50 Hz$ repetitive, $I_T = 45 A$			150	A/ $\mu s$	
		$t_p = 200 \mu s; di_G/dt = 0,3 A/\mu s;$ $I_G = 0,3 A; V_D = 2/3 V_{DRM}$ non-repet., $I_T = 15 A$			500	A/ $\mu s$	
$(dv/dt)_{cr}$	critical rate of rise of voltage	$V_D = 2/3 V_{DRM}$ $R_{GK} = \infty; \text{method 1 (linear voltage rise)}$	$T_{VJ} = 125^{\circ}C$		1000	V/ $\mu s$	
$V_{GT}$	gate trigger voltage	$V_D = 6 V$	$T_{VJ} = 25^{\circ}C$		1	V	
			$T_{VJ} = -40^{\circ}C$		1,2	V	
$I_{GT}$	gate trigger current	$V_D = 6 V$	$T_{VJ} = 25^{\circ}C$		65	mA	
			$T_{VJ} = -40^{\circ}C$		80	mA	
$V_{GD}$	gate non-trigger voltage	$V_D = 2/3 V_{DRM}$	$T_{VJ} = 125^{\circ}C$		0,2	V	
$I_{GD}$	gate non-trigger current				5	mA	
$I_L$	latching current	$t_p = 30 \mu s$	$T_{VJ} = 25^{\circ}C$		150	mA	
		$I_G = 0,3 A; di_G/dt = 0,3 A/\mu s$					
$I$	holding current	$V_D = 6 V \quad R_{GK} = \infty$	$T_{VJ} = 25^{\circ}C$		100	mA	
$t_{gd}$	gate controlled delay time	$V_D = 1/2 V_{DRM}$	$T_{VJ} = 25^{\circ}C$		2	$\mu s$	
		$I_G = 0,3 A; di_G/dt = 0,3 A/\mu s$					
$t_q$	turn-off time	$V_R = 100 V; I_T = 15 A; V_D = 2/3 V_{DRM}$ $di/dt = 10 A/\mu s; dv/dt = 20 V/\mu s; t_p = 300 \mu s$	$T_{VJ} = 125^{\circ}C$		150	$\mu s$	

Package V1-B-Pack			Ratings			
Symbol	Definition	Conditions	min.	typ.	max.	Unit
$I_{RMS}$	RMS current	per terminal			100	A
$T_{VJ}$	virtual junction temperature		-40		125	°C
$T_{op}$	operation temperature		-40		100	°C
$T_{stg}$	storage temperature		-40		125	°C
<b>Weight</b>				30		g
$M_D$	mounting torque		2		2,5	Nm
$d_{Spp/App}$	creepage distance on surface   striking distance through air	terminal to terminal	6,0			mm
$d_{Spb/Appb}$		terminal to backside	12,0			mm
$V_{ISOL}$	isolation voltage	t = 1 second	3600			V
		t = 1 minute	3000			V

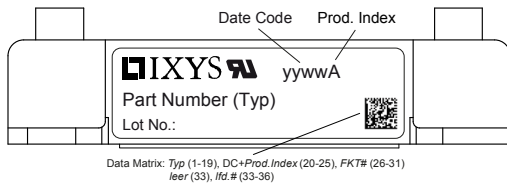

Ordering	Ordering Number	Marking on Product	Delivery Mode	Quantity	Code No.
Standard	VVZ40-16io1	VVZ40-16io1	Box	5	466379

### Equivalent Circuits for Simulation

\* on die level

$T_{VJ} = 125\text{ °C}$

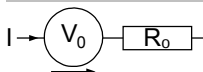

Thyristor

$V_{0\ max}$	threshold voltage	0,85	V
$R_{0\ max}$	slope resistance *	12,5	mΩ

**Outlines V1-B-Pack**

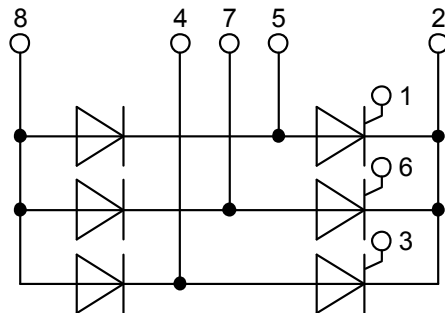
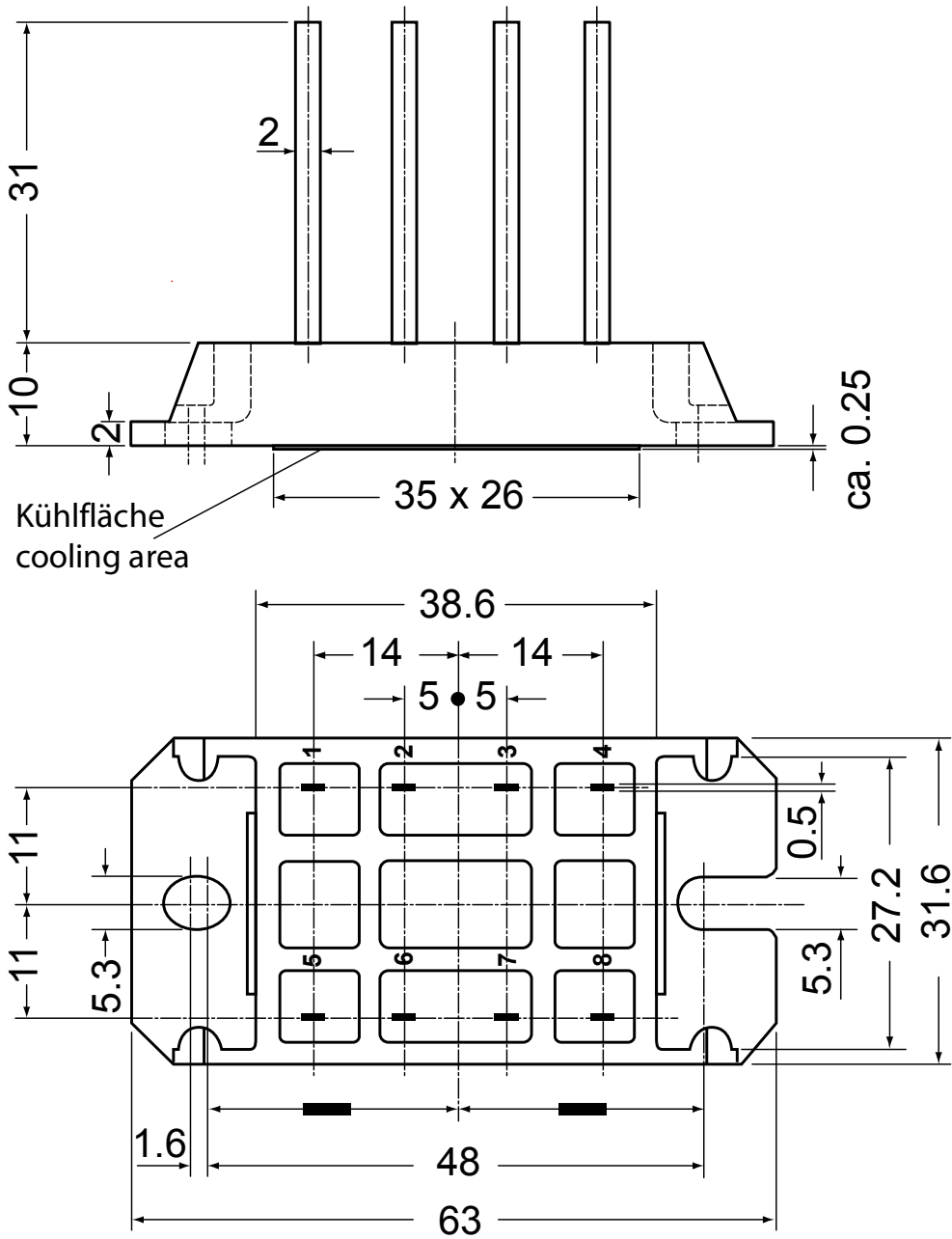

## Thyristor

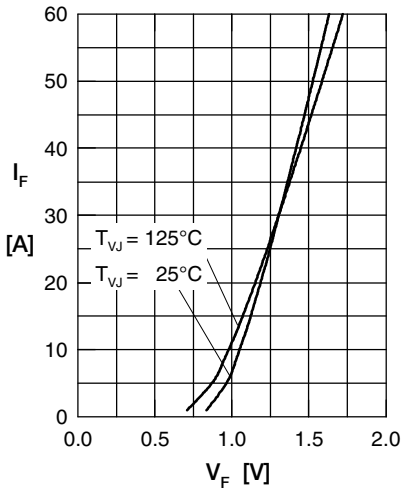

Fig. 1 Forward current vs. voltage drop per thyristor

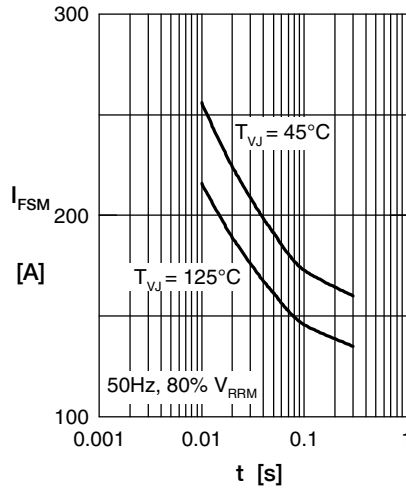

Fig. 2 Surge overload current vs. time per thyristor

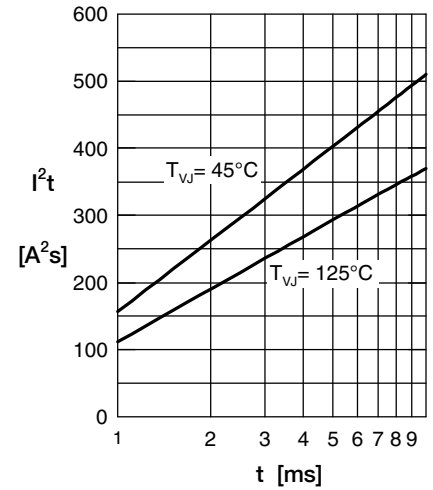

Fig. 3  $I^2t$  vs. time per thyristor

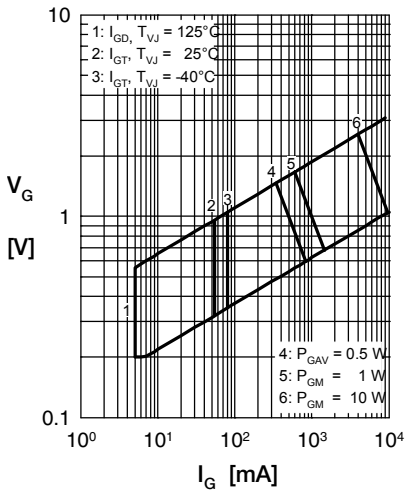

Fig. 4 Gate trigger characteristics

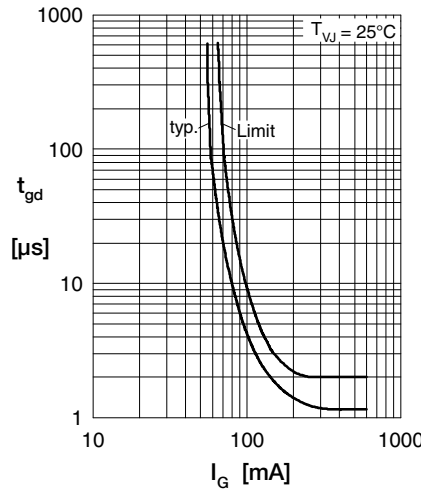

Fig. 5 Gate trigger delay time

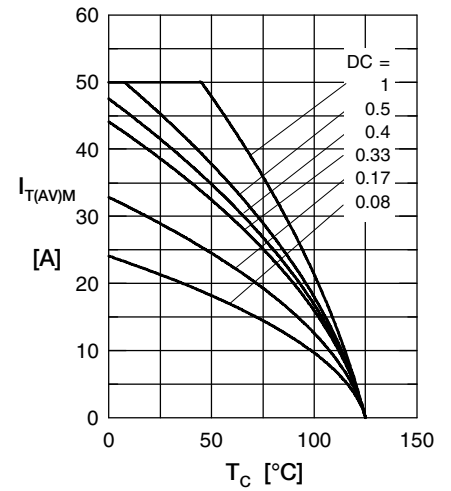

Fig. 5 Max. forward current vs. case temperature per thyristor

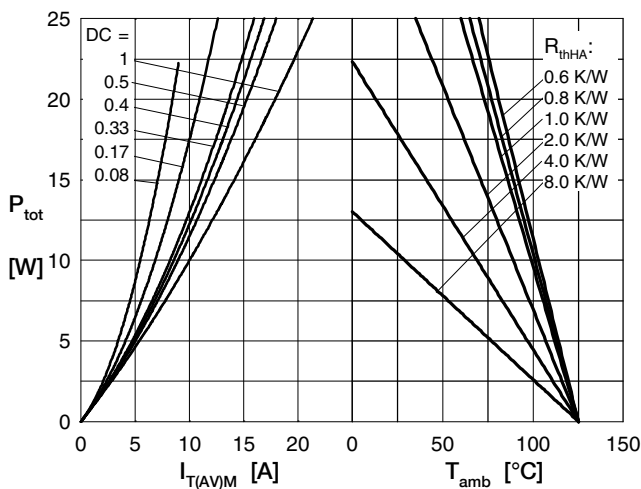

Fig. 4 Power dissipation vs. forward current and ambient temperature per thyristor

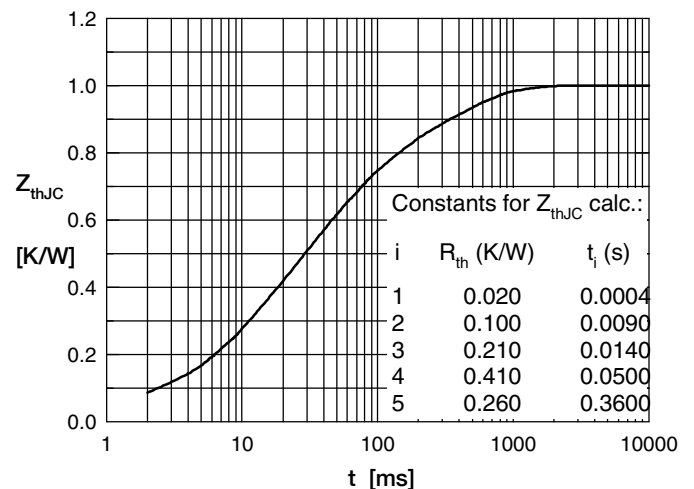

Fig. 6 Transient thermal impedance junction to case vs. time per thyristor