

THIS DOCUMENT IS THE PROPERTY OF  
KEYSTONE ELECTRONICS CORP. AND  
SHALL NOT BE REPRODUCED, DISTRIBUTED  
OR USED AS A BASIS FOR MANUFACTURE  
WITHOUT PRIOR WRITTEN PERMISSION  
FROM KEYSTONE ELECTRONICS CORP.

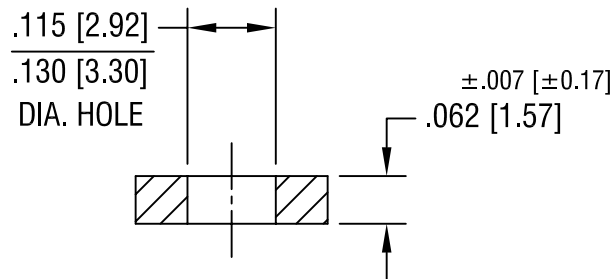
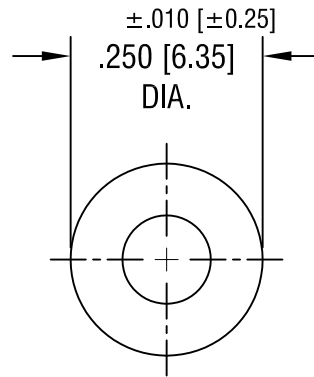

**KEYSTONE ELECTRONICS CORP.**

ASTORIA, N.Y. 11105-2017

PART NAME

FLAT WASHER

MATERIAL

.062 [1.57] TH'K NYLON

FINISH

-

DRN BY

BOONE

DATE

8.26.82

APP'D

LN

SCALE

4X

9.15.94

CHANGE AS PER ECR 94-053

A

TOLERANCES

INCH [MM]

CODE

DWG NO.

DECIMAL ±.005 [±0.15]

C/M

ANGULAR ± 1°  
UNLESS OTHERWISE SPECIFIED

**3358**

DATE

DESCRIPTION

REV.