

5

4

3

2

1



D

C

B

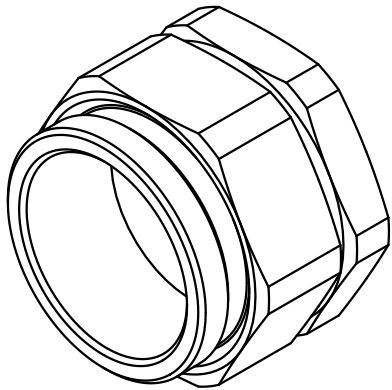
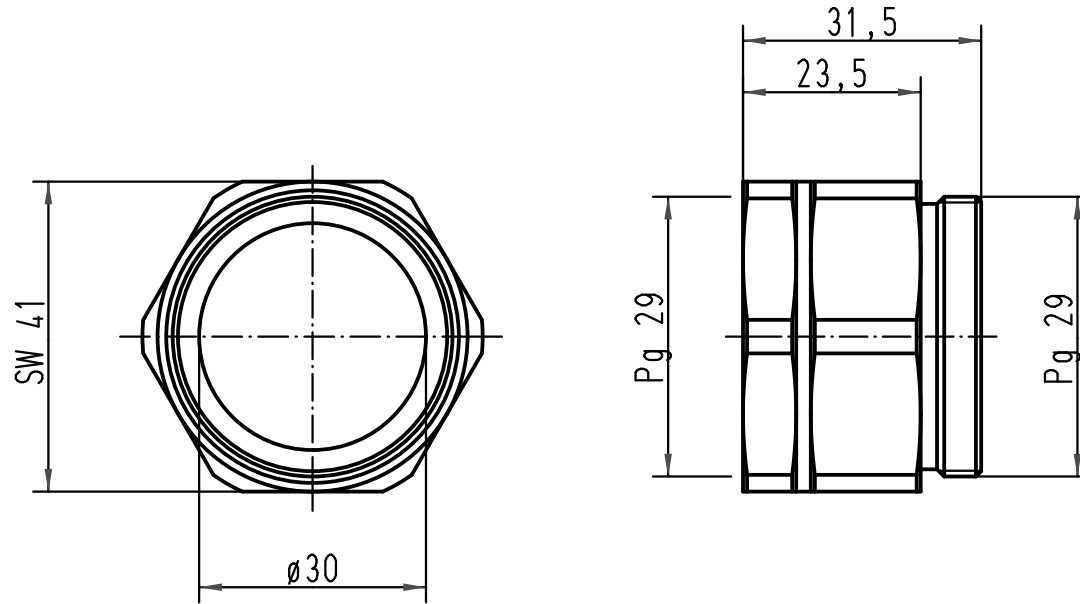
A



 All Dimensions in mm Original Size DIN A 4			Techn. Character.			Nicht tolerierte Maße/Free size tolerances		
				Dat.	Name	Maßstab/Scale 1:1	Zwischenstutzen Pg29 adapter Pg29	
			Detail.	18.11.99	Gü			
			Insp.		Sdt			
			Stand.					
413222	19.09.07	DY	HARTING Electric GmbH & Co. KG				TB 09 36 000 5135	
26690			D-32339 Espelkamp					
Mod.	Dat.	Name					Sub.	Blatt/page