

DETAIL B
SCALE 10:1

NOTES

1. MATERIAL:
HOUSING - HIGH TEMPERATURE THERMOPLASTIC GLASS FILLED. UL 94V-0. BLACK.
TERMINALS - COPPER ALLOY
SOLDER RING / NAIL: NICKEL SILVER
2. PLATING:
CONTACT AREA - 0.76um MIN GOLD OVER 2.54um MIN NICKEL
SOLDER AREA - 2.54um MIN TIN OVER 2.54um MAX NICKEL
3. TERMINAL SOLDER FEET TO BE COPLANAR WITHIN 0.10/.004 MEASURED FROM FRONT HOUSING STAND OFF (DATUM -BB-)
4. DATE CODE: 4 DIGIT (3 DIGIT DATE, 1 DIGIT YEAR)
5. CIRCUIT IDENTIFIER: SEE APPROPRIATE INDUSTRY SPECIFICATION FOR LOCATION OF PIN 1
6. PACKAGED PER PACKING SPECIFICATION: 2027188000
7. CONFORMS TO PRODUCT SPECIFICATION: 2027189010-PS
8. APPLICATION SPECIFICATION: 2027189030-AS
9. THIS PART CONFORMS TO CLASS C REQUIREMENTS OF COSMETIC SPECIFICATION PS-45499-002

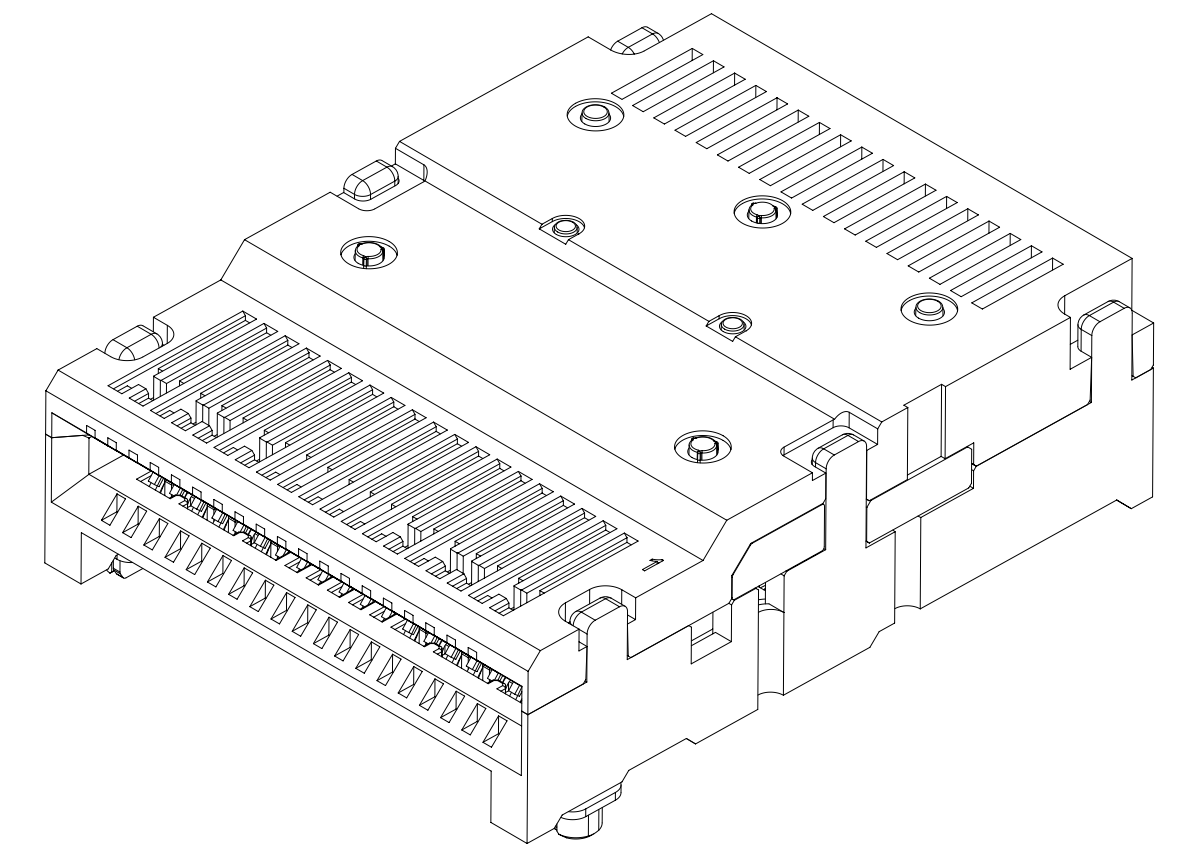

SYMBOLS										THIS DRAWING CONTAINS INFORMATION THAT IS PROPRIETARY TO MOLEX ELECTRONIC TECHNOLOGIES, LLC AND SHOULD NOT BE USED WITHOUT WRITTEN PERMISSION									
DIMENSION UNITS					SCALE					CURRENT REV DESC: SEE REVISION TABLE									
mm					5:1					EC NO: 175630 DRWN: MCAIN 2018/04/24 CHK'D: MWOLFE 2018/05/07 APPR: SMILLER 2018/05/10 INITIAL REVISION: DRWN: LZHUANG06 2017/04/07 APPR: SMILLER 2017/12/18									
GENERAL TOLERANCES (UNLESS SPECIFIED)																			
ANGULAR TOL ± 1.0°										DOCUMENT NUMBER									
4 PLACES ±										2027180100									
3 PLACES ±										DOC TYPE DOC PART REVISION									
2 PLACES ± 0.13										PSD 000 C									
1 PLACE ± 0.25										MATERIAL NUMBER CUSTOMER SHEET NUMBER									
0 PLACES ±										202718-0100 1 OF 6									
DRAFT WHERE APPLICABLE MUST REMAIN WITHIN DIMENSIONS										THIRD ANGLE PROJECTION DRAWING SERIES									
										C-SIZE 202718									

PIN OUT TABLE

PIN #	Symbol	Description	Notes
1	GND	Ground	
2	TX2n	Transmitter Inverted Data Input	
3	TX2p	Transmitter Non-Inverted Data Input	
4	GND	Ground	
5	TX4n	Transmitter Inverted Data Input	
6	TX4p	Transmitter Non-Inverted Data Input	
7	GND	Ground	
8	ModSelL	Module Select	
9	ResetL	Module Reset	
10	VCC RX	+3.3V Power Supply Receiver	
11	SCL	2-wire serial interface clock	
12	SDA	2-wire serial interface data	
13	GND	Ground	
14	RX3p	Receiver Non-Inverted Data Output	
15	RX3n	Receiver Inverted Data Output	
16	GND	Ground	
17	RX1p	Receiver Non-Inverted Data Output	
18	RX1n	Receiver Inverted Data Output	
19	GND	Ground	
20	GND	Ground	
21	RX2n	Receiver Inverted Data Output	
22	RX2p	Receiver Non-Inverted Data Output	
23	GND	Ground	
24	RX4n	Receiver Inverted Data Output	
25	RX4p	Receiver Non-Inverted Data Output	
26	GND	Ground	
27	ModPrsL	Module Present	
28	IntL	Interrupt	
29	VCC TX	+3.3V Power supply transmitter	
30	VCC1	+3.3V Power supply	
31	LPMODE	Low Power Mode	
32	GND	Ground	
33	TX3p	Transmitter Non-Inverted Data Input	
34	TX3n	Transmitter Inverted Data Input	
35	GND	Ground	
36	TX1p	Transmitter Non-Inverted Data Input	
37	TX1n	Transmitter Inverted Data Input	
38	GND	Ground	
39	GND	Ground	
40	TX6n	Transmitter Inverted Data Input	
41	TX6p	Transmitter Non-Inverted Data Input	
42	GND	Ground	
43	TX8n	Transmitter Inverted Data Input	
44	TX8p	Transmitter Non-Inverted Data Input	
45	GND	Ground	
46	TBD	For future use	
47	TBD	For future use	
48	VCC	+3.3V Power supply	
49	TBD	For future use	
50	TBD	For future use	
51	GND	Ground	
52	RX7p	Receiver Non-Inverted Data Output	
53	RX7n	Receiver Inverted Data Output	
54	GND	Ground	
55	RX5p	Receiver Non-Inverted Data Output	
56	RX5n	Receiver Inverted Data Output	
57	GND	Ground	
58	GND	Ground	
59	RX6n	Receiver Inverted Data Output	
60	RX6p	Receiver Non-Inverted Data Output	
61	GND	Ground	
62	RX8n	Receiver Inverted Data Output	
63	RX8p	Receiver Non-Inverted Data Output	
64	GND	Ground	
65	NC	No Connect	
66	TBD	For future use	
67	VCC	+3.3V Power supply	
68	VCC	+3.3V Power supply	
69	TBD	For future use	
70	GND	Ground	
71	TX7p	Transmitter Non-Inverted Data Input	
72	TX7n	Transmitter Inverted Data Input	
73	GND	Ground	
74	TX5p	Transmitter Non-Inverted Data Input	
75	TX5n	Transmitter Inverted Data Input	
76	GND	Ground	

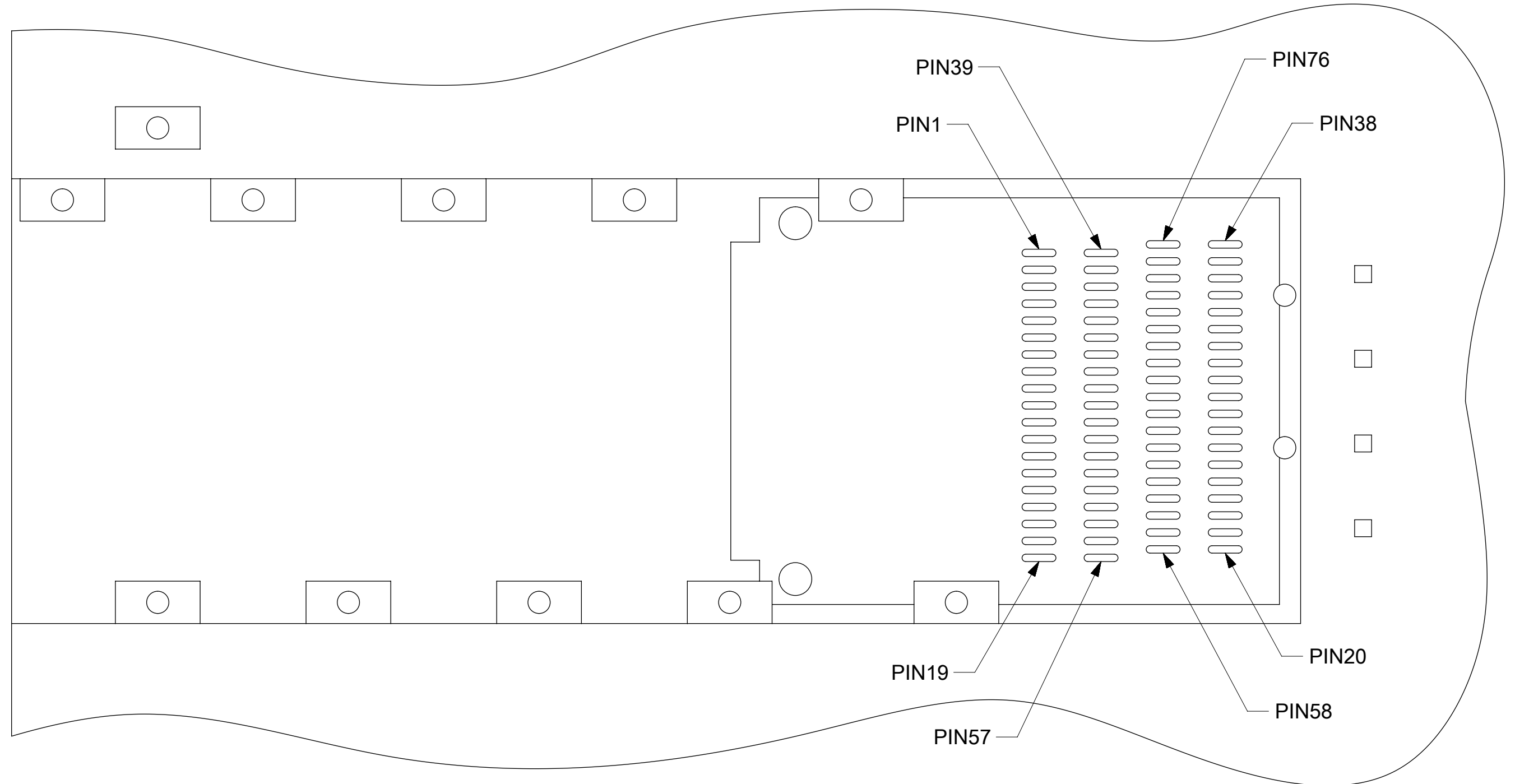

Notes:
 * Reference only.
 ** Please align QSFP-DD MSA for pin mapping

THIS DRAWING CONTAINS INFORMATION THAT IS PROPRIETARY TO MOLEX ELECTRONIC TECHNOLOGIES, LLC AND SHOULD NOT BE USED WITHOUT WRITTEN PERMISSION									
SYMBOLS		DIMENSION UNITS		SCALE		CURRENT REV DESC: SEE REVISION TABLE			
▽ = 0		mm		5:1		EC NO: 175630 DRWN: MCAIN 2018/04/24 CHK'D: MWOLFE 2018/05/07 APPR: SMILLER 2018/05/10			
▽ = 0		GENERAL TOLERANCES (UNLESS SPECIFIED)							
▽ = 0		ANGULAR TOL		± 1.0°		INITIAL REVISION: DRWN: LZHUANG06 2017/04/07 APPR: SMILLER 2017/12/18			
▽ = 0		4 PLACES		±					
▽ = 0		3 PLACES		±		PRODUCT CUSTOMER DRAWING DOCUMENT NUMBER: 2027180100 DOC TYPE: PSD DOC PART: 000 REVISION: C			
▽ = 0		2 PLACES		± 0.13					
▽ = 0		1 PLACE		± 0.25		MATERIAL NUMBER: 202718-0100 CUSTOMER:			
▽ = 0		0 PLACES		±					
▽ = 0		DRAFT WHERE APPLICABLE MUST REMAIN WITHIN DIMENSIONS		THIRD ANGLE PROJECTION		DRAWING: C-SIZE		SERIES: 202718	
▽ = 0								SHEET NUMBER: 3 OF 6	



ASSEMBLY DDQ SMT CONNECTOR 76CKT

PRODUCT CUSTOMER DRAWING

2027180100 PSD 000 C

202718-0100

PCB LAYOUT FOR BELLY TO BELLY MOUNTING

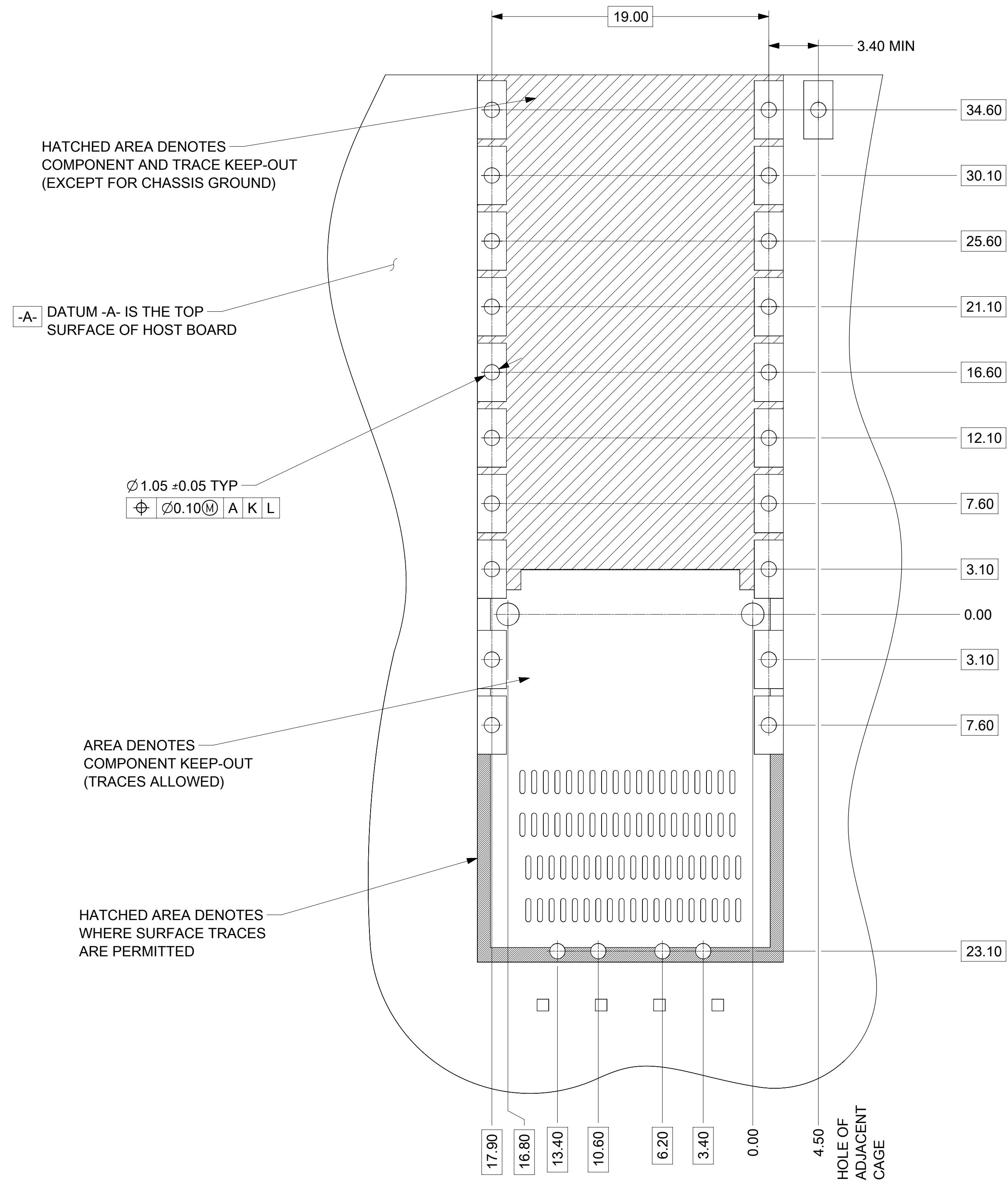

- NOTES:
1. PADS AND VIAS GO TO CHASSIS GROUND. (RECOMMENDED PADS TO BE 2.00X4.00MM).
 2. RECOMMENDED THRU HOLE PLATING INCLUDES HASL, OSP, OR IMMERSION (GOLD, SILVER, OR TIN).
 3. CONNECTOR PAD LAYOUT PER DDQ-MSA WILL ACCOMODATE MOLEX CONNECTOR 2027180100.

SYMBOLS	THIS DRAWING CONTAINS INFORMATION THAT IS PROPRIETARY TO MOLEX ELECTRONIC TECHNOLOGIES, LLC AND SHOULD NOT BE USED WITHOUT WRITTEN PERMISSION		
	DIMENSION UNITS	SCALE	CURRENT REV DESC: SEE REVISION TABLE
$\nabla = 0$	mm	5:1	molex ASSEMBLY DDQ SMT CONNECTOR 76CKT PRODUCT CUSTOMER DRAWING EC NO: 175630 DRWN: MCAIN 2018/04/24 CHK'D: MWOLFE 2018/05/07 APPR: SMILLER 2018/05/10 INITIAL REVISION: DRWN: LZHUANG06 2017/04/07 APPR: SMILLER 2017/12/18
$\nabla = 0$	GENERAL TOLERANCES (UNLESS SPECIFIED)		
$\nabla = 0$	ANGULAR TOL $\pm 1.0^\circ$		
$\nabla = 0$	4 PLACES	\pm	
$\nabla = 0$	3 PLACES	\pm	
$\nabla = 0$	2 PLACES	± 0.13	
$\nabla = 0$	1 PLACE	± 0.25	
$\nabla = 0$	0 PLACES	\pm	
$\nabla = 0$	DRAFT WHERE APPLICABLE MUST REMAIN WITHIN DIMENSIONS	THIRD ANGLE PROJECTION	DOCUMENT NUMBER 2027180100 DOC TYPE PSD DOC PART 000 REVISION C
$\nabla = 0$	DRAWING	SERIES	MATERIAL NUMBER 202718-0100 CUSTOMER SHEET NUMBER 4 OF 6
$\nabla = 0$	D-SIZE	202718	

BEZEL AND BOARD POSITION DIMENSIONS FOR SINGLE SIDE MOUNTING

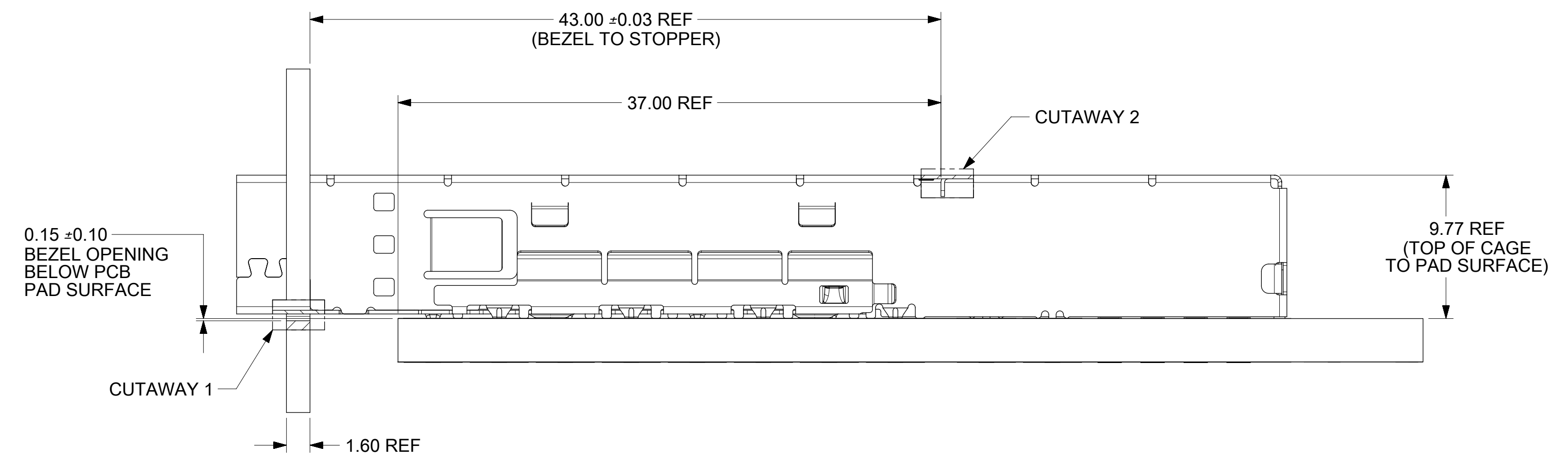
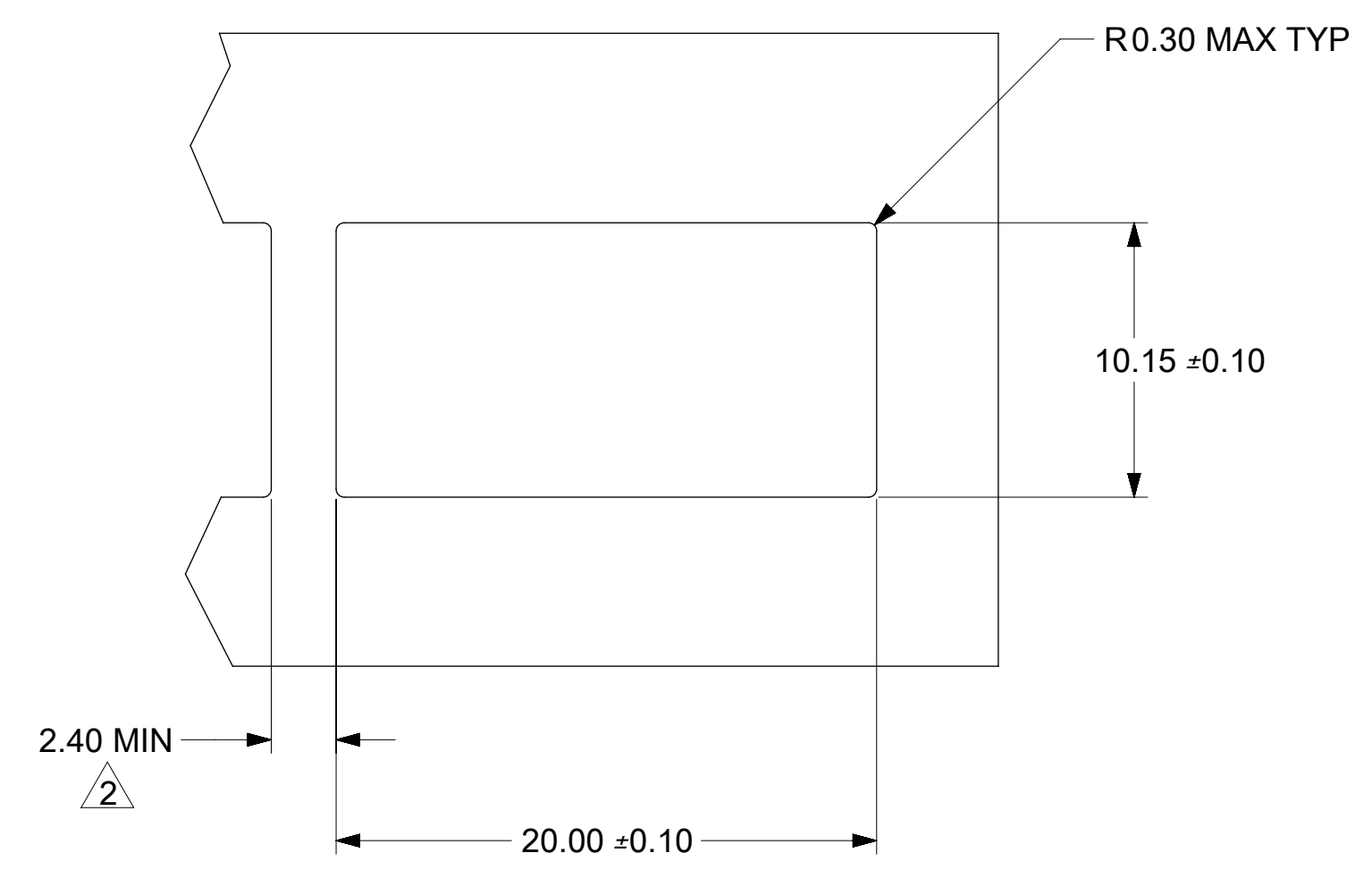

BEZEL AND BOARD POSITION DIMENSIONS FOR BELLY TO BELLY MOUNTING

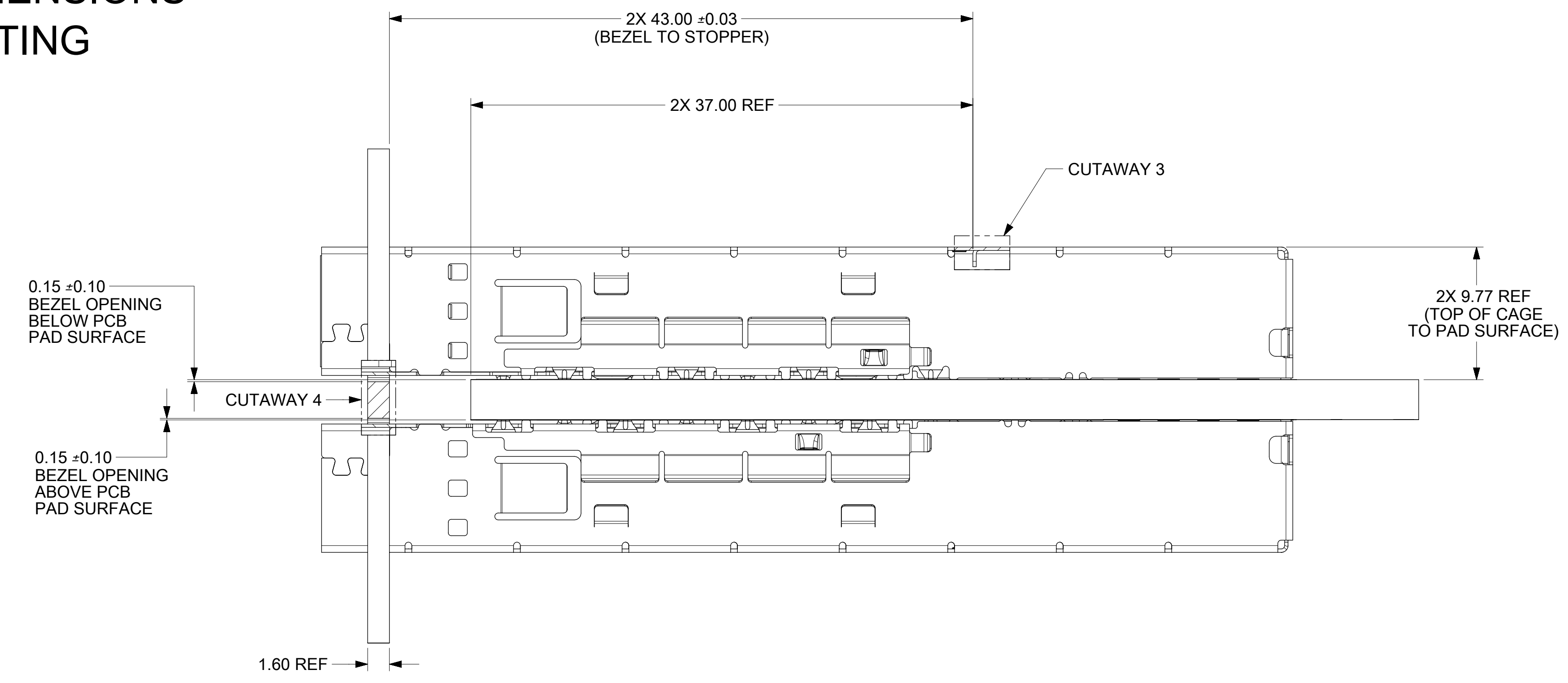
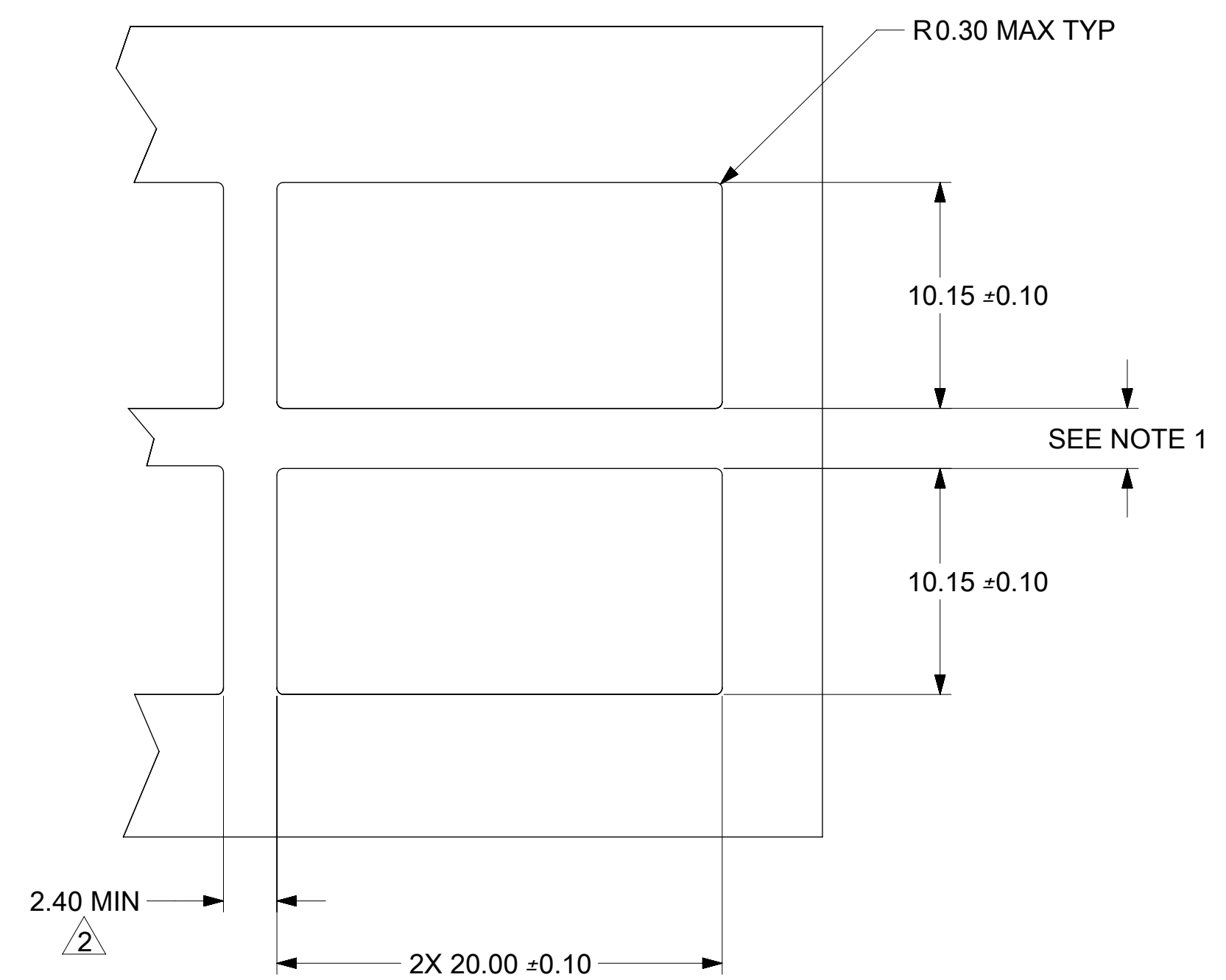

NOTES:
 1. PCB THICKNESS VARIATION MUST BE CONSIDERED WHEN DETERMINING BEZEL OPENING, SIZE, AND LOCATION.
 2. THIS DIMENSION IS FOR REFERENCE ONLY, USER CAN MODIFY DEPENDING ON APPLICATION, OPENING FOR ADJACENT CAGE ON PCB LAYOUT VARIES BASED ON MODIFICATION.

SYMBOLS	THIS DRAWING CONTAINS INFORMATION THAT IS PROPRIETARY TO MOLEX ELECTRONIC TECHNOLOGIES, LLC AND SHOULD NOT BE USED WITHOUT WRITTEN PERMISSION			
	DIMENSION UNITS	SCALE	CURRENT REV DESC: SEE REVISION TABLE	
▽ = 0	mm	4:1	 ASSEMBLY DDQ SMT CONNECTOR 76CKT PRODUCT CUSTOMER DRAWING	
▽ = 0	GENERAL TOLERANCES (UNLESS SPECIFIED)			
▽ = 0	ANGULAR TOL ± 1.0°			
▽ = 0	4 PLACES	±		
▽ = 0	3 PLACES	±		
▽ = 0	2 PLACES	± 0.13		
▽ = 0	1 PLACE	± 0.25	EC NO: 175630 DRWN: MCAIN 2018/04/24 CHK'D: MWOLFE 2018/05/07 APPR: SMILLER 2018/05/10	
☒ = 0	0 PLACES	±	INITIAL REVISION: DRWN: LZHUANG06 2017/04/07 APPR: SMILLER 2017/12/18	
■ = 0	DRAFT WHERE APPLICABLE MUST REMAIN WITHIN DIMENSIONS		THIRD ANGLE PROJECTION 	
▽ = 0	DRAWING		SERIES D-SIZE 202718	
DOCUMENT NUMBER		DOC TYPE	DOC PART	REVISION
2027180100		PSD	000	C
MATERIAL NUMBER		CUSTOMER		SHEET NUMBER
202718-0100				5 OF 6

REVISION	DATE	DISCRIPTION
1	04/07/2017	INITIAL CONCEPT
2	09/27/2017	ADDED SHEET SHOWING VIEWS OF BOTH SINGLE SIDE AND BELLY TO BELLY MOUNTING, ADDED SOLDER PAD FOR HOUSING RETENTION, AND ADHESIVE PADS ADDED EXPLODED VIEWS
A	12/06/2017	INITIAL PROPOSAL - (ER)
A1	12/18/2017	INITIAL RELEASE (NEW PRODUCT)
B	12/21/2017	UPDATE VIEWS
B1	02/02/2018	UPDATE VIEWS, ADD PK AS PS SPEC, ADD ADHESIVE PADS NOTE, CORRECT BELLY TO BELLY PCB LAYOUT
B2	4/11/2018	ALIGN DIMENSIONAL CALLOUTS TO MATCH MSA
C	4/25/2018	ADD TWO PASS REFLOW PROCESS NOTE

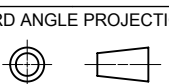
SYMBOLS										THIS DRAWING CONTAINS INFORMATION THAT IS PROPRIETARY TO MOLEX ELECTRONIC TECHNOLOGIES, LLC AND SHOULD NOT BE USED WITHOUT WRITTEN PERMISSION									
DIMENSION UNITS		SCALE		CURRENT REV DESC: SEE REVISION TABLE															
mm		1:1																	
▽ = 0		GENERAL TOLERANCES (UNLESS SPECIFIED)		EC NO: 175630										ASSEMBLY DDQ SMT CONNECTOR 76CKT PRODUCT CUSTOMER DRAWING					
▽ = 0		ANGULAR TOL ± 1.0°		DRWN: MCAIN 2018/04/24															
▽ = 0		4 PLACES ±		CHK'D: MWOLFE 2018/05/07										DOCUMENT NUMBER 2027180100					
▽ = 0		3 PLACES ±		APPR: SMILLER 2018/05/10														DOC TYPE	
▽ = 0		2 PLACES ± 0.13		INITIAL REVISION:										PSD		000		C	
▽ = 0		1 PLACE ± 0.25		DRWN: LZHUANG06 2017/04/07										MATERIAL NUMBER		CUSTOMER		SHEET NUMBER	
▽ = 0		0 PLACES ±		APPR: SMILLER 2017/12/18										202718-0100				6 OF 6	
▽ = 0		DRAFT WHERE APPLICABLE MUST REMAIN WITHIN DIMENSIONS		THIRD ANGLE PROJECTION		DRAWING		SERIES		MATERIAL NUMBER		CUSTOMER		SHEET NUMBER					
▽ = 0						C-SIZE		202718		202718-0100				6 OF 6					