

## DESCRIPTION

The 78Q2120C09-DB is a design example for a 10/100BASE-TX Mbit/second Fast Ethernet MII Interface adaptor. The 78Q2120C09 transceiver provides the network physical interface and MII (Medium Independent Interface) interface.

Teridian Semiconductor's 78Q2120C09 is an auto-sensing, auto-switching 10/100BASE-TX Fast Ethernet transceiver with full duplex operation capability. The device interfaces directly to the IEEE-802.3u MII port. Full-featured MII management functions are included along with an extended register set. A five bit configurable PHY address is provided for multiple PHY architectures. The 78Q2120C09 interfaces to CAT5 UTP cable via a 1:1 transformer.

The transceiver's transmitter includes on-chip the pulse shaper and low power line driver. The receiver incorporates a sophisticated combination of real-time adaptive equalization, an adaptive DC offset adjustment circuit and baseline wander correction. Smart squelch circuitry further improves the receiver's noise rejection. Full featured auto-negotiation or parallel detect modes are supported.

Using 0.18 $\mu$ m CMOS technology, the 78Q2120C09 operates at +3.3V. Intelligent power management and power down modes minimize power consumption. The demo board requires operation with a +3.3V power supply.

### Design Kit contains:

- √ 78Q2120C09 MII Demo Board
- √ Demo Board Parts List
- √ P.C.B. Gerber Files
- √ Demo Board schematic
- √ 78Q2120C09 Data Sheet

## 100Base-TX Interface

### RJ45 Pin Assignment

Pin	Signal	Pin	Signal
1	TX+	5	N/C
2	TX-	6	RX-
3	RX+	7	N/C
4	N/C	8	N/C

## MII: Medium Independent Interface

### Pin Assignment:

(40 Pin Male Subminiature D, 0.050)

Pin	Signal	Pin	Signal
1	+3.3V	21	+3.3V
2	MDIO	22	COMMON
3	MDC	23	COMMON
4	RXD3	24	COMMON
5	RXD2	25	COMMON
6	RXD1	26	COMMON
7	RXD0	27	COMMON
8	RXDV	28	COMMON
9	RXCLK	29	COMMON
10	RXER	30	COMMON
11	TXER	31	COMMON
12	TXCLK	32	COMMON
13	TXEN	33	COMMON
14	TXD0	34	COMMON
15	TXD1	35	COMMON
16	TXD2	36	COMMON
17	TXD3	37	COMMON
18	COL	38	COMMON
19	CRS	39	COMMON
20	+3.3V	40	+3.3V

**MII ADAPTOR WITH 78Q2120C09**Switch Positions

The OFF switch position sets a logic level = "1" and conversely, the ON position sets a logic level = "0".  
Some DIP switch markings are different.

ON equals CLOSED.  
OFF equals OPEN.

For normal operation switch SW2 should be set as follows:

ISO	ON
ISODEF	ON
TEST	ON
PAD4:0	PHY Address = 0, the 78Q2120C09 responds to all accesses PHY Address = non-zero, the 78Q2120C09 responds only to its unique address

For normal operation the following SW1 switches should be set as follows:

N/U	OFF (not used)
PCSBP	ON
PWRDN	ON

Switch SW1 positions ANEGA and TECH0:2 set the line interface technology capabilities.  
Refer to the data sheet for a complete description.

For full Auto-Negotiation capabilities, set ANEGA and TECH0:2 to OFF.

Use With the Netcom Smart-Bits

The Netcom expects to be the master and defaults to 100BASE-TX Half-Duplex operation. To allow Fast-Ether Windows to reconfigure the 78Q2120C09's control register MR0 bits, set ANEGA and TECH0:2 all to OFF. If the 78Q2120C09's technology pins are set to anything else, the 78Q2120C09 will disable some modes and prevent the Netcom from reconfiguring the 78Q2120C09 and data errors may be observed.

After initialization the 78Q2120C09 defaults to 100BASE-TX Full-Duplex operation. When connected to another fully capable transceiver, the transceivers will be in full-duplex mode. The default configuration of the Netcom is 100BASE-TX Half-Duplex operation. If data transfers were to commence, the Netcom would display Collision errors (because it does not automatically read the transceivers and reconfigure).

If a transceiver is used which defaults to 100BASE-TX Half-Duplex operation, the 78Q2120C09 will adjust itself for half-duplex operation (assuming the 78Q2120C09 is setup for the proper technologies).

To establish proper operation between the 78Q2120C09 and the Netcom, click on the "Options" button followed by selecting "Full Duplex MII". Repeat selecting "Full Duplex MII" twice to ensure that everything is configured identically.

The 78Q2120C09 can be configured for half-duplex operation (ANEGA = ON and TECH0:2 = ON, OFF, ON) to minimize incompatibilities with other transceivers and the Netcom.

## 10/100Mbps Transformer Selection

The line interface for the 78Q2120C09 requires a pair of 1:1 isolation transformers. Integrated common-mode chokes are recommended for satisfying FCC radiated EMI requirements. Additional filtering is not required with the 78Q2120C09 due to internal waveform shaping circuitry. The line transformer characteristics are outlined below:

Name	Value	Condition
Turns Ratio	1 CT : 1 CT	
Open-Circuit Inductance	350 $\mu$ H (min) See Note 1.	@ 10 mV, 10 KHz
Leakage Inductance	0.40 $\mu$ H (max)	@ 1 Mhz (min)
Inter-Winding Capacitance	25 pF (max)	
D.C. Resistance	0.9 ohm (max)	
Insertion Loss	1.1 dB (typ)	0 - 100 Mhz
HIPOT	1500 Vrms	

Note 1: The receive line transformer's Open-Circuit Inductance can be as low as 100  $\mu$ H for the 78Q2120C09. The 78Q2120C09 incorporates baseline wander correction circuitry which allows the receiver to track the incoming data signal when there is excessive transformer droop.

### For Commercial Temperature (0°C ~ 70°C)

Teridian Semiconductor has performed line testing with the following transformers and found their performance acceptable with the 78Q2120C09:

<u>Manufacturer</u>	<u>Part Number</u>
TDK	TLA-6T103
Bel-Fuse	S558-5999-46
Halo	TG22-3506ND
Pulse	PE-68515
Valor	ST6118
YCL	20PMT04

The following transformers are low profile packages (0.100 in/2.5 mm or less).

TDK	TLA-6T118
Halo	TG110-S050
PCA	EPF8023G

The following devices integrate the transformers, RJ45 connector, LEDs and termination resistors.

**Commercial Temperature Connectors**

Vendor	Part number	Tab up /down	LED	LED color (L/R)	Shielding	Lead-free	Compatible Footprints *
Pulse	J0011D21	Down	No	N/A	Yes	No	a
	J0011D21NL	Down	No	N/A	Yes	Yes	a
	J0011D21B	Down	Yes	G/Y	Yes	No	b
	J0011D21BNL	Down	Yes	G/Y	Yes	Yes	b
	J0011D21E	Down	Yes	G/G	Yes	No	b
	J0011D21ENL	Down	Yes	G/G	Yes	Yes	b
	J0011D01	Down	No	N/A	Yes	No	a
	J0011D01NL	Down	No	N/A	Yes	Yes	a
	J0011D01B	Down	Yes	G/Y	Yes	No	b
	J0011D01BNL	Down	Yes	G/Y	Yes	Yes	b
	J0012D21	Down	No	N/A	Yes	No	a
	J0012D21NL	Down	No	N/A	Yes	Yes	a
	J1011F01P	Up	Yes	G/Y	Yes	No	A
	J1011F01PNL	Up	Yes	G/Y	Yes	Yes	A
	J1011F21P	Up	Yes	G/Y	Yes	No	A
	J1011F21PNL	Up	Yes	G/Y	Yes	Yes	A
Halo	HFJ11-2450EURL	Down	No	N/A	No	Yes	e
	HFJ11-2450EU-L11RL	Down	Yes	G/G	No	Yes	f
	HFJ11-2450ERL	Down	No	N/A	Yes	Yes	c
	HFJ11-2450E-L11RL	Down	Yes	G/G	Yes	Yes	d
	HFJT1-S003E-L11RL	Up	Yes	G/G	Yes	Yes	B
	HFJT1-S003-L11RL	Up	Yes	G/G	Yes	Yes	C
	HFJT1-S003	Up	No	N/A	Yes	Yes	D

**Commercial Temperature Connectors (continued)**

Vendor	Part number	Tab up /down	LED	LED color (L/R)	Shielding	Lead-free	Compatible Footprints *
Würth/Midcom	MIC24010-5101T-LF3	Down	No	N/A	Yes	Yes	b
	MIC24010-5104T-LF3	Down	No	N/A	Yes	Yes	b
	MIC24011-0101T	Down	Yes	Y/G	Yes	No	b
	MIC24011-0101T-LF3	Down	Yes	Y/G	Yes	Yes	b
	MIC24011-0101W-LF3	Down	Yes	Y/G	Yes	Yes	b
	MIC24011-0104T	Down	Yes	Y/G	Yes	No	b
	MIC24012-5101T-LF3	Down	Yes	G/G	Yes	Yes	b
	MIC24012-5204T-LF3	Down	Yes	G/G	Yes	Yes	b
	MIC24013-5104T	Down	Yes	G/Y	Yes	No	b
	MIC24018-5101T-LF3	Down	Yes	R/G	Yes	Yes	b
	MIC24019-0101T	Down	Yes	G/R	Yes	No	b
	MIC24111-0101T	Up	Yes	Y/G	Yes	No	A
	MIC24111-0101T-LF3	Up	Yes	Y/G	Yes	Yes	A
	MIC24412-0128T-LF3	Up	Yes	G/G	No	Yes	E
	MIC24F11-0101T-LF3	Up	Yes	Y/G	No	Yes	F
Falco	LJ0004	Down	No	N/A	Yes	Yes	a
	LJ0012	Down	No	N/A	Yes	No	a
	LJ1011	Down	Yes	G/Y	Yes	No	d
BelFuse	SI-10021	Down	No	N/A	Yes	No	a
	SI-60002-F	Down	No	N/A	Yes	Yes	a
	SI-40139	Down	Yes	G/G	Yes	No	d
	SI-60001-F	Down	Yes	G/G	Yes	Yes	d
	SI-50170	Up	Yes	G/G	Yes	No	A
	SI-50170-F	Up	Yes	G/G	Yes	Yes	A
	SI-50177	Up	No	N/A	Yes	No	D
	SI-50177-F	Up	No	N/A	Yes	Yes	D
	SI-50193	Up	No	N/A	No	No	G
	SI-50193-F	Up	No	N/A	No	Yes	G
	SI-50196	Up	Yes	G/G	No	No	F
	SI-50196-F	Up	Yes	G/G	No	Yes	F
TDK	TLA-6T704	Down	No	N/A	Yes	Yes	a
	TLA-6T707	Down	No	N/A	Yes	Yes	a

\* Notes:

1. The letters stand for different footprint drawings
2. Lower case is for the tab-down version. Upper case is for tab-up version.
3. The compatible connectors are labeled with the same letter.

The above evaluations were performed using Netcom's Smart-Bits Fast Ethernet Analyzer. The Teridian Semiconductor 78Q2120C09 MII Adapter and Lancaster Fast Ethernet Adapter were attached to the Netcom's Ports A & B respectively. Twisted pair Category 5 General Cable P/N 459360 was used to connect the two transceivers. 100 Mbps performance was measured using cable lengths of both 12 inches and 115 meters. 10 Mbps performance was evaluated using 100 meters of Category 3 cable.

The Netcom was configured to use the Baseline Wander Packet file. Packet length was 1500 bytes.

All transformers listed above met or exceeded IEEE's 802.3 Bit Error Rate requirements of  $10^{-8}$ .

## PCB Layout Considerations

The following recommendations enhance the 78Q2120C09's performance while minimizing EMC emissions:

1. The transformer to transceiver signal traces must be 100 ohm differential transmission lines.
2. Place the termination network components near the input data pins of the transceiver or transformer.
3. Make all differential signal pairs short and of the same length.
4. Decouple the transceiver thoroughly with 0.01 $\mu$ f and 0.1 $\mu$ f capacitors.
5. Locate these decoupling capacitors as close as possible to the respective transceiver VCC and GND pins.
6. All decoupling capacitor and transceiver VCC and GND connections should tie immediately to a VCC or GND plane via with minimum trace inductance.
7. Total decoupling capacitance should be greater than the load capacitance that the digital output drivers must drive.
8. Use low inductance, ceramic surface mount decoupling capacitors.
9. Use a multi-layer PCB with the inner layers dedicated to GND and VCC.
10. A single VCC and GND plane is recommended for optimum performance. The lowest possible series impedance is required between the analog and digital VCC and GND pins respectively of the transceiver.
11. The outer layers of a 4 layer PCB are to be used for signal routing.
12. Place the highest speed signals on the layer adjacent to the GND plane.
13. Physically separate the analog signals from the digital signals by placing them on opposite layers or routing them away from each other.
14. Additional component and solder side ground layers may be added for maximum EMC containment.
15. The GND plane should extend out to the transceiver side of the transformer. Remove the VCC and GND planes from the line side of the transformer to the RJ-45 connector.
16. Do not allow the chassis ground plane to cross over the transceiver GND plane. Minimum separation must accommodate over 1.5KV.
17. Provide onboard termination of the unused signal pairs in the CAT-5 cable.
18. Use a shielded RJ-45 connector with its case stakes soldered to the chassis ground.
19. Locate the transformer adjacent to the RJ-45 to minimize the shunt capacitance to the line.
20. Minimize RF current fringing by making the VCC plane 0.10 inch smaller than the GND plane. If multiple transceivers are used, provide partitions in the VCC and GND planes between the analog sections. Maintain the partition from the transformer up to the transceiver's analog interface. Do not cross these partitions with signal traces, in particular any digital signals from adjacent transceivers.
21. Add series resistors on all transceiver MII outputs to minimize digital output driver peak currents.
22. Minimize the use of vias when routing the analog signal traces.
23. Isolate the crystal and its capacitors from the analog signals with a guard ring.
24. The crystal compensation capacitor value (C11 & C12) must be selected to trim the oscillator's frequency to 25.0000 MHz  $\pm$ 50ppm. The optimum value will be layout dependent. A mere  $\pm$ 4pf can shift the 25MHz  $\pm$ 100Hz. The 25.0000 MHz  $\pm$ 50ppm is specified by the IEEE.

Note: System vendors need to select the proper crystal according to their applications, such as operating environment, product lifetime, and etc since crystal aging, operating temperature, and other factors can affect the crystal frequency tolerance.

Note: This demo board schematic is only applicable for the 78Q2120C09 revision.

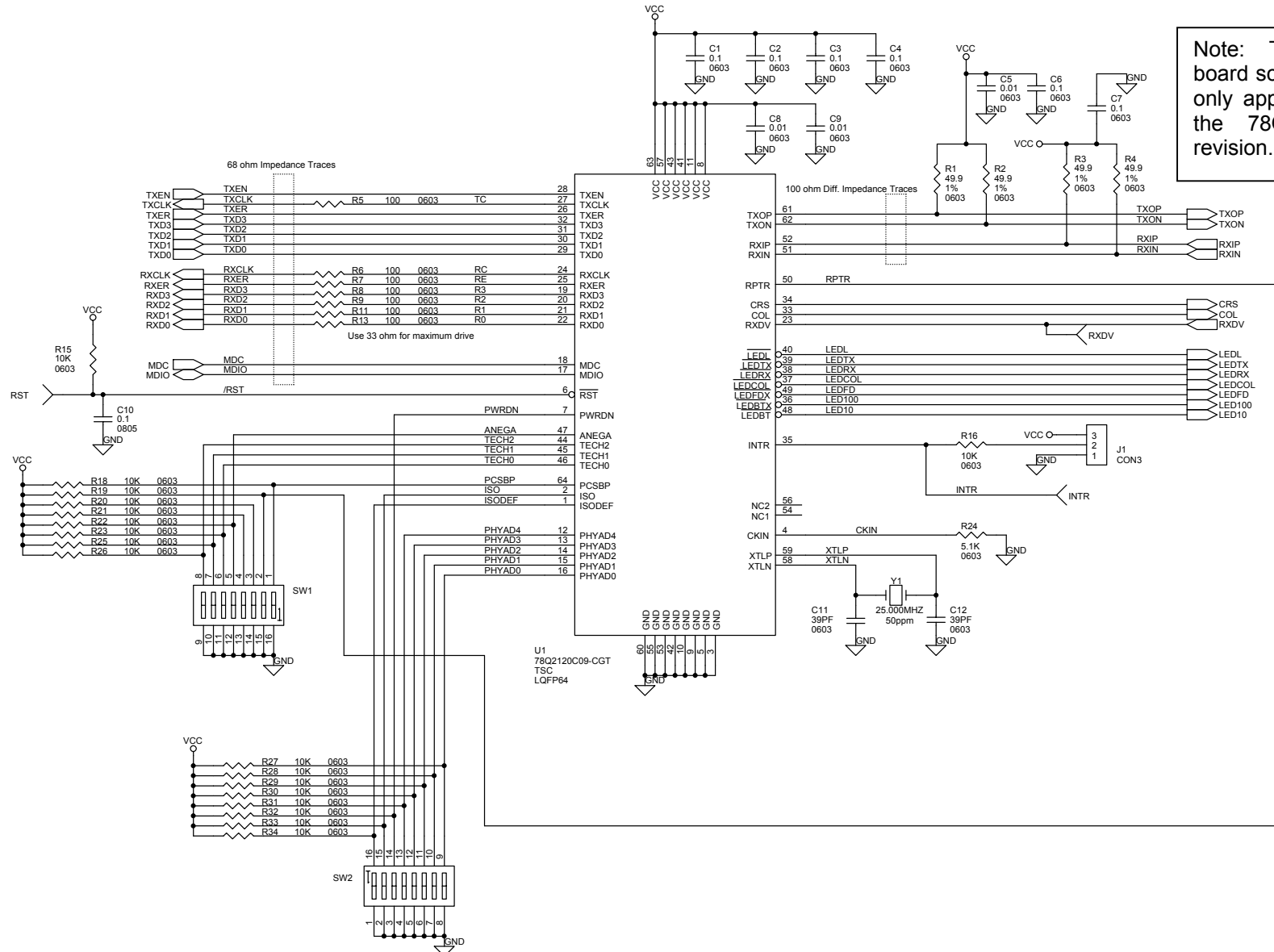

**78Q2120C09 Evaluation Board Schematic – MII Interface**



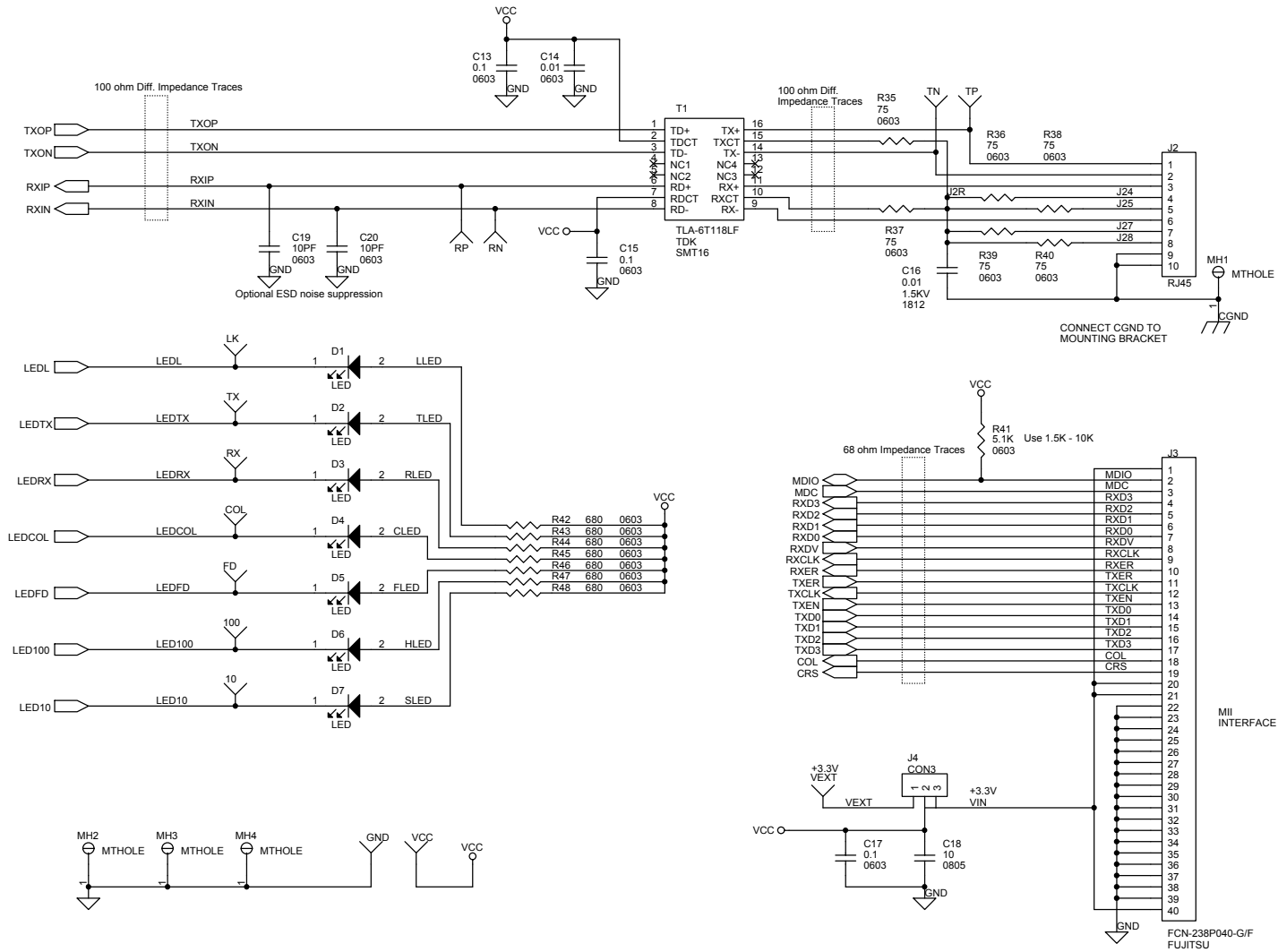

**78Q2120C09 Evaluation Board Schematic – Line Interface**

### 78Q2120C09 MII Demo Board Parts List

QTY	REFERENCE NUMBER	DESCRIPTION	PART NUMBER	PACKAGE	MANUFACTURER
1	U1	IC, 10/100Mbps LAN Transceiver	78Q2120C09-CGT	LQFP64	TSC
2	SW1,SW2	DIP SWITCH, 8 POS			
1	T1	XFRM, 10BaseT/100BaseTX	TLA-6T118LF	SMT16	TDK
1	Y1	CRYSTAL, 25.000MHZ	ECCM1-25.000MHZ	ECCM1	ECLIPTEK
7	D1,D2,D3,D4,D5,D6,D7	LED	LU20125	R/A	LUMEX
6	R35,R36,R37,R38,R39,R40	RES, 75		CC0603	
7	R5,R6,R7,R8,R9,R11,R13	RES, 100		CC0603	
7	R42,R43,R44,R45,R46,R47,R48	RES, 680		CC0603	
2	R24,R41	RES, 5.1K		CC0603	
18	R15,R16,R18,R19,R20,R21,R22,R23,R24,R25,R26,R27,R28,R29,R30,R31,R32,R33,R34	RES, 10K		CC0603	
4	R1,R2,R3,R4	RES, 49.9, 1%		CC0603	
2	C19,C20	CAP, CER, 10PF		CC0603	Optional
2	C11,C12	CAP, CER, 39PF		CC0603	
4	C5,C8,C9,C14	CAP, CER, 0.01UF		CC0603	
9	C1,C2,C3,C4,C6,C7,C13,C15,C17	CAP, CER, 0.1UF	C1608Y5V1H104Z	CC0603	TDK
1	C10	CAP, CER, 0.1UF	C2012Y5V1H104Z	CC0805	TDK
1	C16	CAP, CER, 0.01UF, 1.5KV		CC1812	
1	C18	CAP, CER, 10UF, 10V		CC0805	
1	J2	CONN, RJ45, SHIELDED	558342-1		AMP
1	J3	CONN, MALE, 40 PIN	FCN-238P040-G/F		FUJITSU
1		P.C.B.			

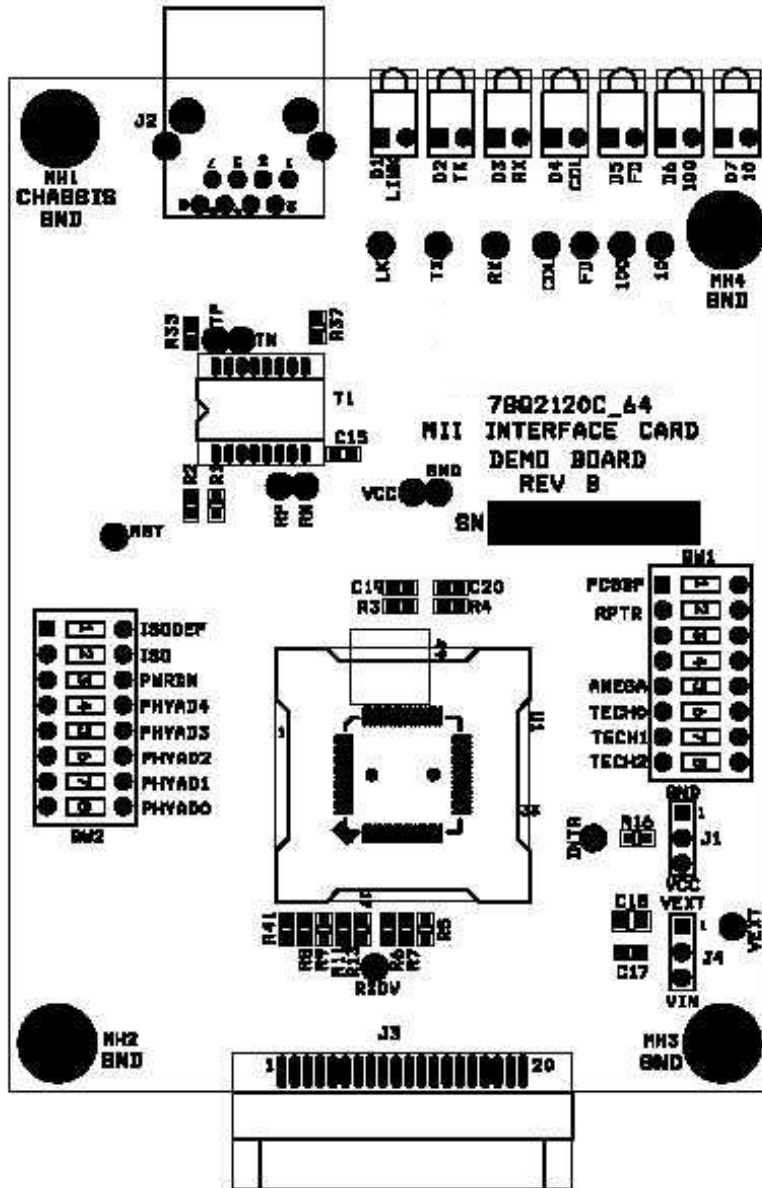

**Top Silkscreen**

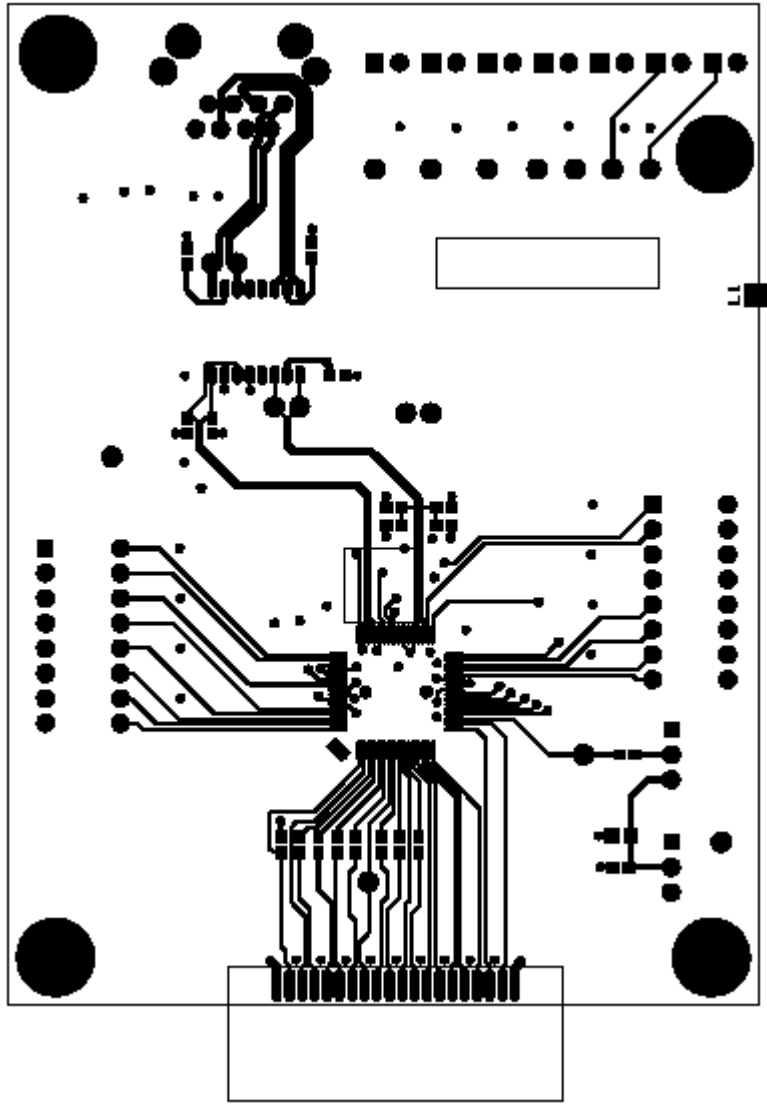

Top Layer

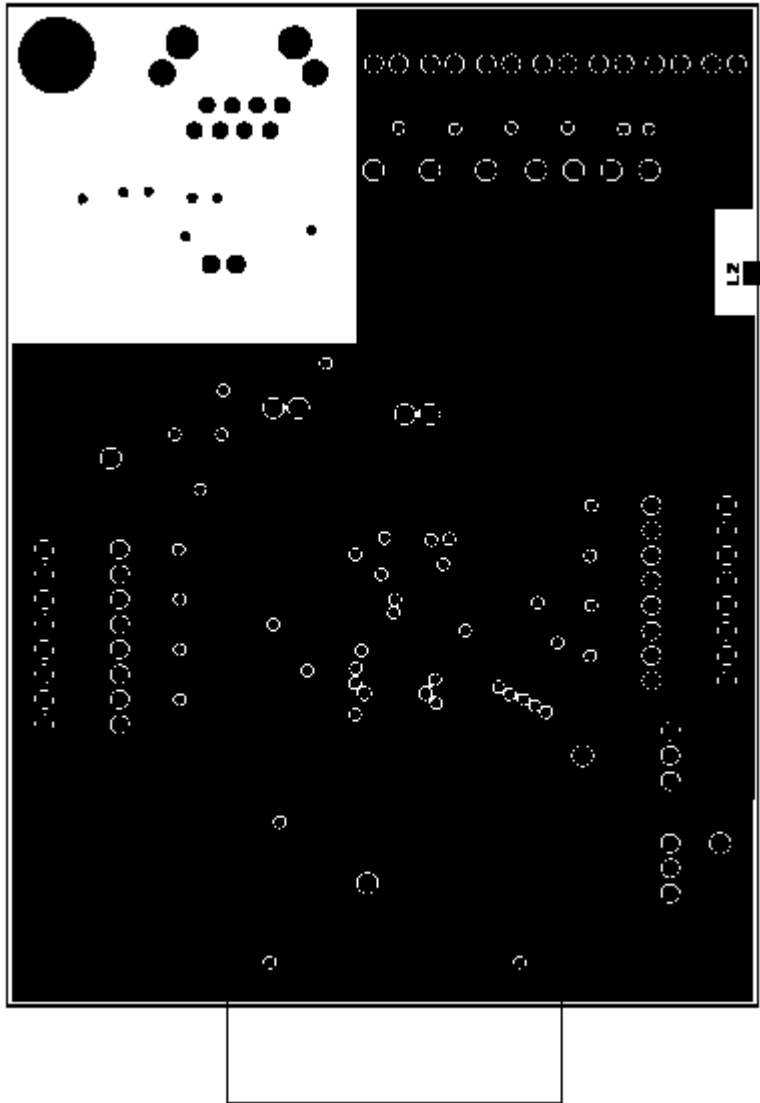

**VCC Layer**

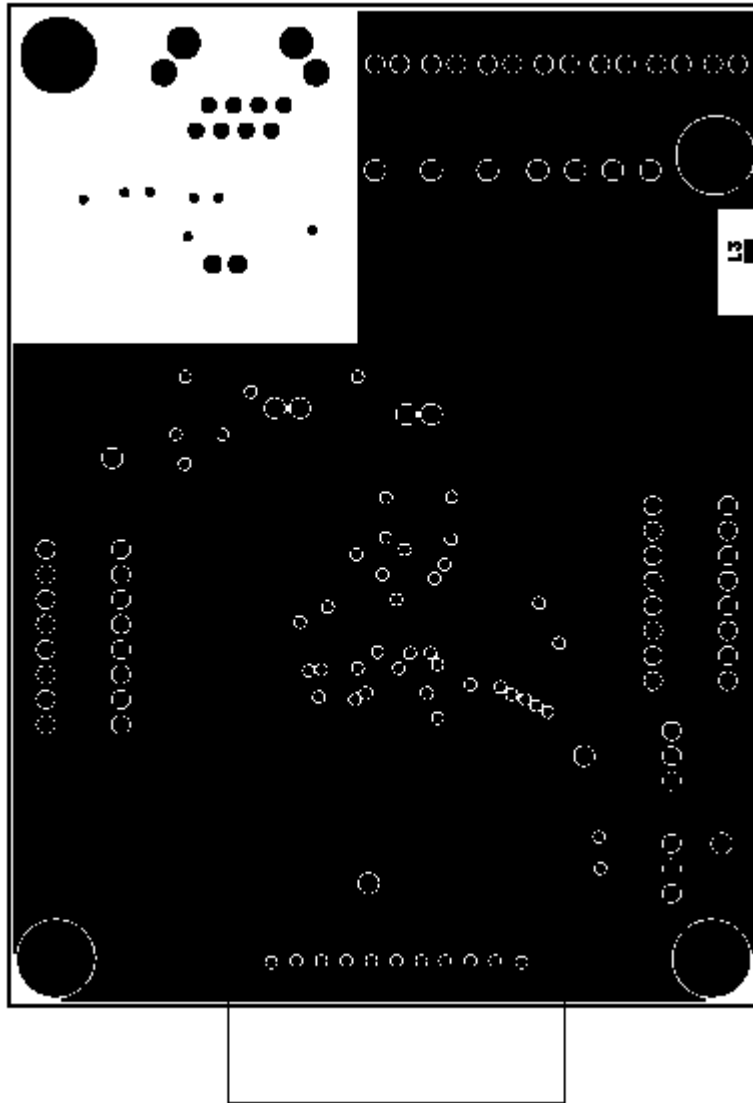

**Ground Layer**

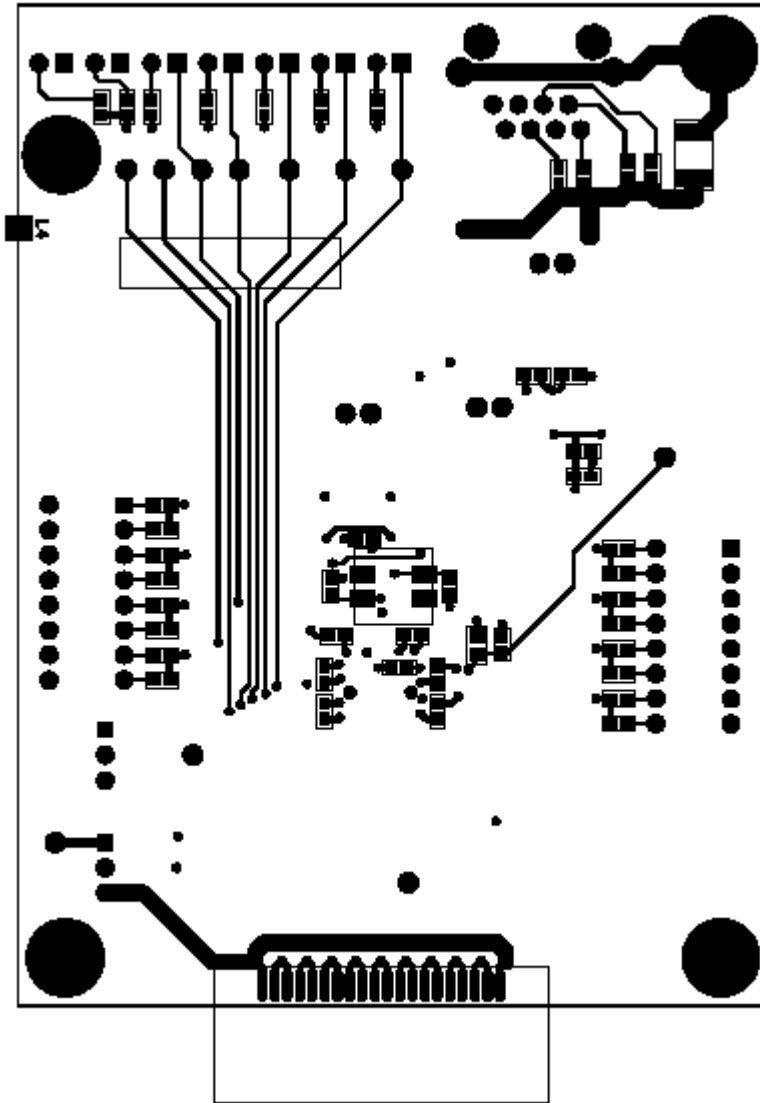

**Bottom Layer**

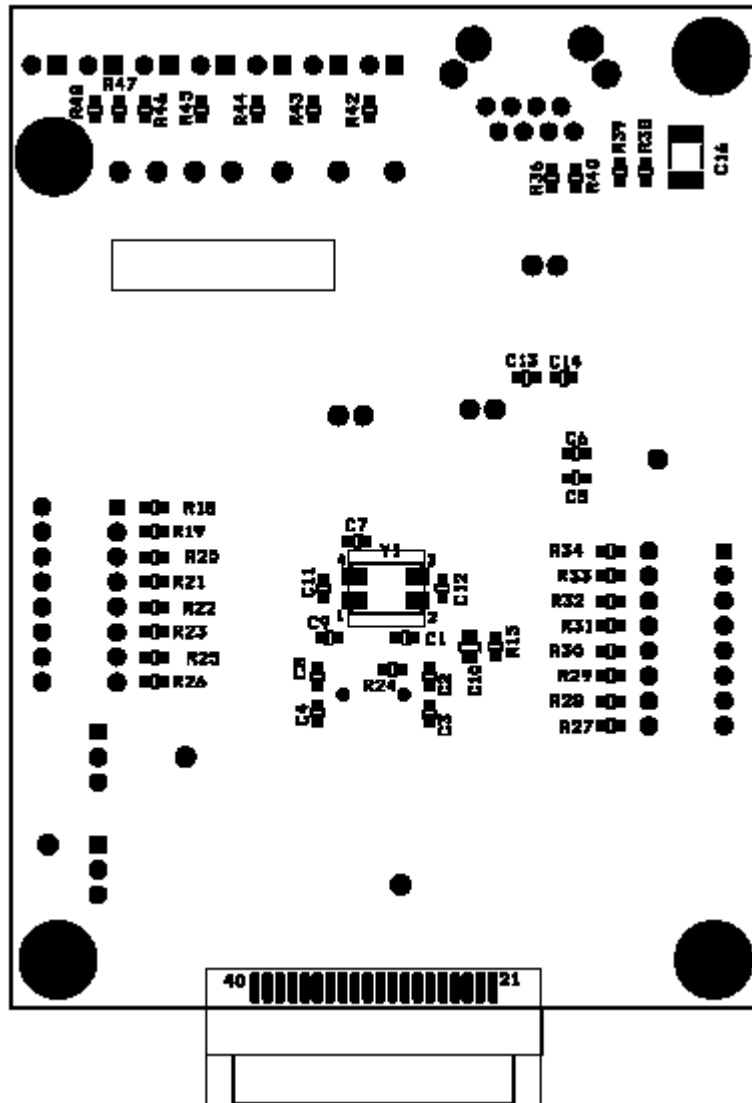

**Bottom Silkscreen**

No responsibility is assumed by TERIDIAN SEMICONDUCTOR CORPORATION for use of this product or for any infringements of patents and trademarks or other rights of third parties resulting from its use. No license is granted under any patents, patent rights or trademarks of Teridian Semiconductor Corporation, and the company reserves the right to make changes in specifications at any time without notice. Accordingly, the reader is cautioned to verify that the data sheet is current before placing orders.

Teridian Semiconductor Corporation, 6440 Oak Canyon, Irvine, CA 92618-5201, (714) 508-8800, FAX: (714) 508-8877

<http://www.teridian.com>