

4

3

2

1

THIS DRAWING IS UNPUBLISHED. RELEASED FOR PUBLICATION
 © COPYRIGHT BY TYCO ELECTRONICS CORPORATION. ALL RIGHTS RESERVED.

LOC	DIST	REVISIONS					
GP	00	P	LTR	DESCRIPTION	DATE	DWN	APVD
			0	RELEASED PER EC OS13-0207-05	28JUN05	RR	JG

① ZINC PLATED .000200-.000400 THICK,
 CLEAR CHROMATE COATING.

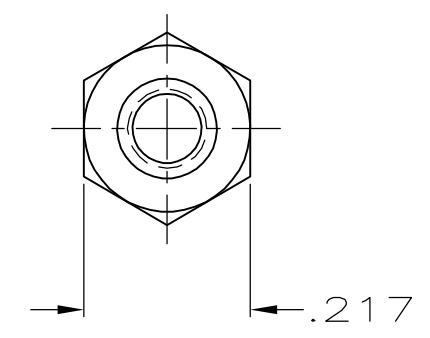
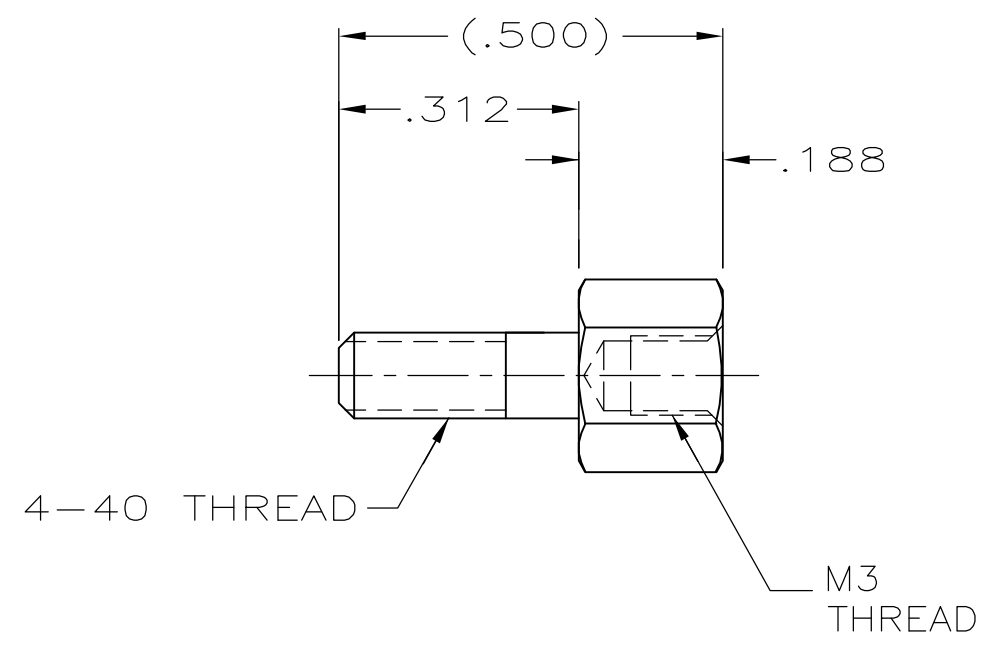

①	5747404-3
FINISH	PART NO

THIS DRAWING IS A CONTROLLED DOCUMENT.		DWN R.RICHARDSON 28JUN05	Tyco Electronics Corporation Harrisburg, Pa 17105-3608													
DIMENSIONS: INCHES		CHK C.ROHDE 28JUN05														
TOLERANCES UNLESS OTHERWISE SPECIFIED:		APVD M.WALMSLEY 28JUN05	NAME SCREWLOCK, FEMALE, METRIC, AMPLIMITE HD-20													
<table border="0"> <tr><td>0 PLC</td><td>± -</td></tr> <tr><td>1 PLC</td><td>± -</td></tr> <tr><td>2 PLC</td><td>± -</td></tr> <tr><td>3 PLC</td><td>± .005</td></tr> <tr><td>4 PLC</td><td>± -</td></tr> <tr><td>ANGLES</td><td>± -</td></tr> </table>		0 PLC	± -	1 PLC	± -	2 PLC	± -	3 PLC	± .005	4 PLC	± -	ANGLES	± -	PRODUCT SPEC -	-	
0 PLC	± -															
1 PLC	± -															
2 PLC	± -															
3 PLC	± .005															
4 PLC	± -															
ANGLES	± -															
MATERIAL STEEL		FINISH SEE TABLE	APPLICATION SPEC -	RESTRICTED TO -												
		WEIGHT -	SIZE A3	CAGE CODE 00779												
		DRAWING NO C-5747404		REV 0												
CUSTOMER DRAWING			SCALE 4:1	SHEET 1 OF 1												