

Integrated AC LED Solution

**Acrich2 – 17W**

SMJD-XV16W2P3



## Product Brief

### Description

- The Acrich2 series of products are designed to be driven directly off the AC line voltage (with an SPC board) and do not need the typical AC/DC converters essential for conventional lighting products
- The converter or driver found in most general lighting products can limit the overall life of the product, but with the Acrich2 series of products the life of the product can more closely be estimated from the LED itself. This will also allow for a much smaller form factor from an overall fixture design allowing for higher creativity in the fixture.
- The modules have a high power factor which can contribute to a higher energy savings in the end application.

### Features and Benefits

- Connects directly to AC line voltage through a Surge Protection circuit (SPC2.5)
- High Power Factor and Low THD
- Long Life Time with Simple BOM
- Miniaturization
- Lead Free Product
- RoHS Compliant

### Key Applications

- Down Light
- Factory Ceiling Light
- Industrial Light
- Flush Mount

**Table 1. Product Selection (CCT)**

Part No.	Vin [Vac]	P [W]	Color	CCT [K]	CRI
					Min.
SMJD-2V16W2P3	120	17	Cool	4700 – 6000	80
SMJD-3V16W2P3	220		Neutral	3700 – 4200	
			Warm	2600 – 3200	

**Table 2. Product Selection (Flux)**

Part No.	Vin [Vac]	P [W]	Flux Bin	Flux [lm]	
				Min.	Typ.
SMJD-2V16W2P3	120	17	17a	1140	1300
SMJD-3V16W2P3	220		17b	1480	1590

---

## Table of Contents

---

Index	
• Product Brief	
• Table of Contents	
• Performance Characteristics	
• Absolute Maximum Ratings	
• Thermal Resistance	
• Relative Spectral Distribution	
• Relative Power Distribution	
• Relative Luminous Distribution	
• Luminous Flux Characteristics	
• Color Bin Structure	
• Part List	
• Mechanical Dimensions	
• Circuit Drawing	
• Marking Information	
• Packing & Label Information	
• Handling of Silicone Resin for LEDs	
• Precaution for Use	
• Company Information	

## Performance Characteristics

**Table 3. Electro Optical Characteristics, T<sub>a</sub> = 25°C**

Parameter	Symbol	Value			Unit	Mark
		Min.	Typ.	Max.		
Luminous Flux	$\Phi_v$ <sup>[2]</sup>	1140	1300	1480	lm	17a
		1480	1590	1700		17b
Correlated Color Temperature <sup>[3]</sup>	CCT	5300	5600	6000	K	B
		4700	5000	5300		C
		3700	4000	4200		E
		2900	3000	3200		G
		2600	2700	2900		H
CRI	Ra	80	-	-	-	
Input Voltage <sup>[4]</sup>	V <sub>in</sub>	120			Vac	2V
		220				3V
Power Consumption	P	16	17	18	W	16W
Operating Frequency	f	50 / 60			Hz	
Power Factor	PF	Over 0.95			-	
Viewing Angle	2 $\Theta_{1/2}$	120			deg.	
Tolerance of Surge <sup>[5]</sup>	V <sub>s</sub>	500	-	-	V	
Transient Protection <sup>[6]</sup>	V <sub>s</sub>	2500	-	-	V	

**Notes :**

- (1) At 120Vac/220Vac, T<sub>a</sub> = 25°C
- (2)  $\Phi_v$  is the total luminous flux output measured with an integrated sphere.
- (3) Correlated Color Temperature is derived from the CIE 1931 Chromaticity diagram.
- (4) Operating Voltage doesn't indicate the maximum voltage which customers use but means tolerable voltage according to each country's voltage variation rate. It is recommended that the solder pad temperature should be below 70 °C.
- (5) Surge withstand in accordance with IEC61000-4-5
- (6) At 120Vac, seven strikes, 100kHz 2.5kV in accordance with ANSI/IEEE C62.41.2-2002 Category A operation

## Absolute Maximum Ratings

**Table 4. Absolute Maximum Ratings,  $T_a = 25^\circ\text{C}$** 

Parameter	Symbol	Unit	Value
Maximum Input Voltage @120Vac	$V_{in}$	Vac	140
Maximum Input Voltage @220Vac			264
Power Consumption	P	W	23
Operating Temperature	$T_{opr}$	$^\circ\text{C}$	-30 ~ 85
Storage Temperature	$T_{stg}$	$^\circ\text{C}$	-40 ~ 100
ESD Sensitivity	-	-	$\pm 4,000\text{V HBM}$

## Thermal Resistance

Part	Package Power Dissipation [W]	Maximum Junction Temperature [°C]	$R_{\theta_{js}}$ [°C/W]
Acrich2 LED	SAW8KG0B Max 0.58	125	27

The Acrich2 LED has a thermal resistance of 27 °C/W from junction of the LED to the LED lead.

The maximum junction temperature of the Acrich2 LED package is 125 °C, therefore the maximum lead temperature  $T_{s\_max}$  is

$$T_{s\_max} = T_{j\_max} - (R_{\theta_{js}} * P_d)$$

$$= 125^{\circ}\text{C} - (27^{\circ}\text{C/W} * 0.58\text{W}) = 109.34^{\circ}\text{C}$$

Although this is the maximum lead temperature, it is recommended to keep the lead temperature under 70 °C.

## Relative Spectral Distribution

Fig 1. Relative Spectral Distribution vs. Wavelength Characteristic – G, H

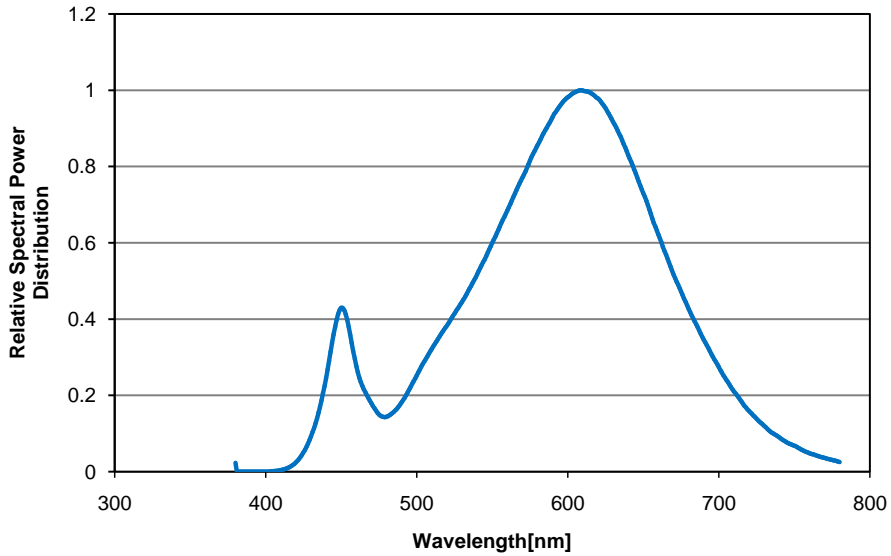
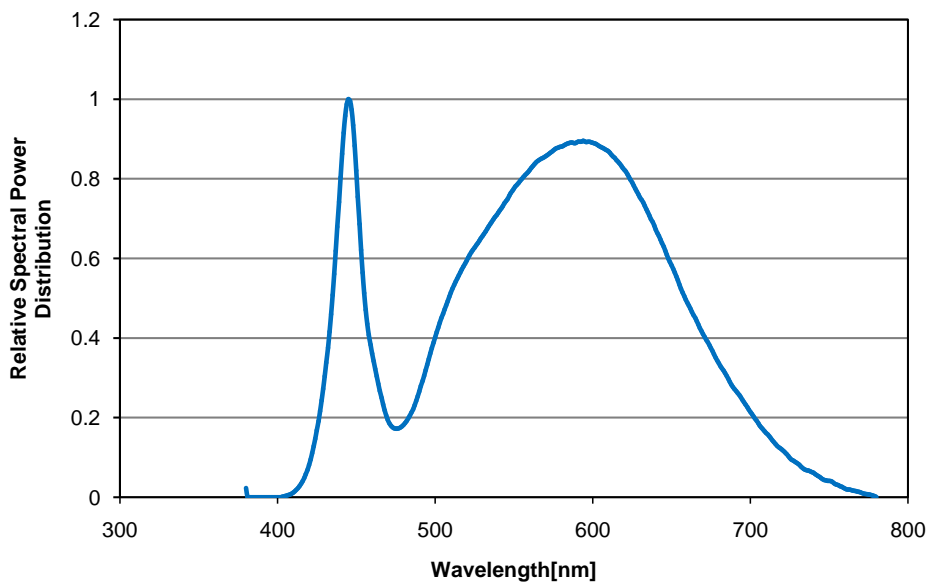
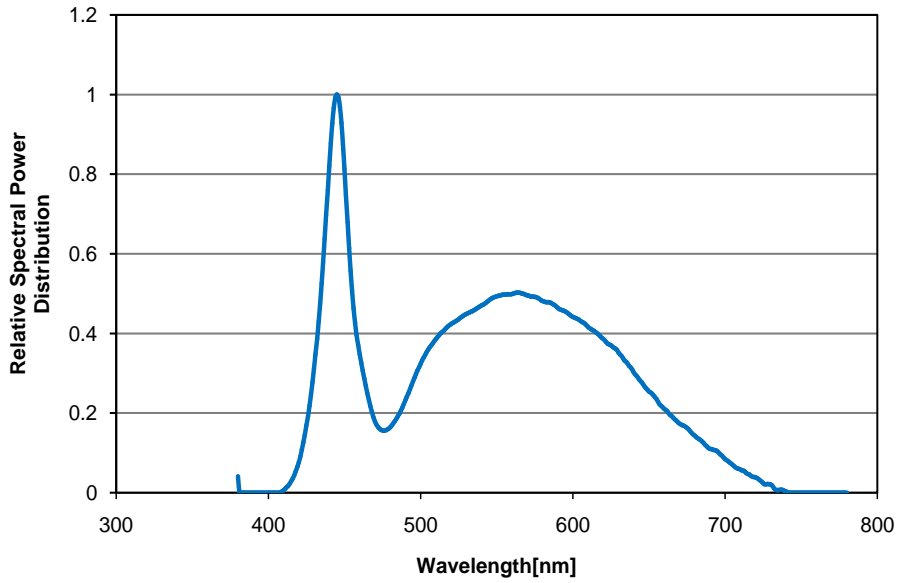

Fig 2. Relative Spectral Distribution vs. Wavelength Characteristic – E



## Relative Spectral Distribution

Fig 3. Relative Spectral Distribution vs. Wavelength Characteristic – B, C



## Relative Power Distribution

Fig 4. Relative Power Distribution vs. Voltage at  $T_a = 25^\circ\text{C}$ , 120V

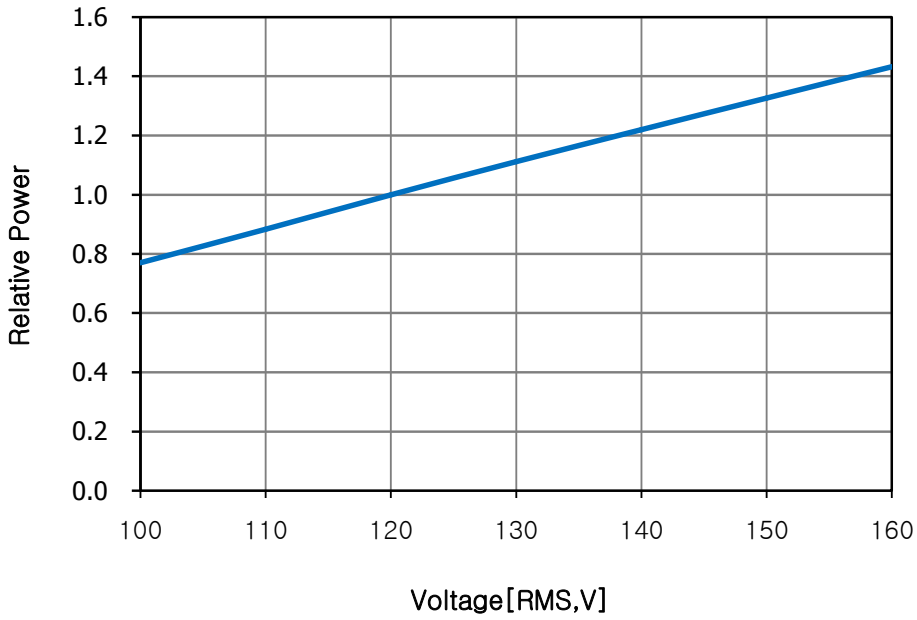
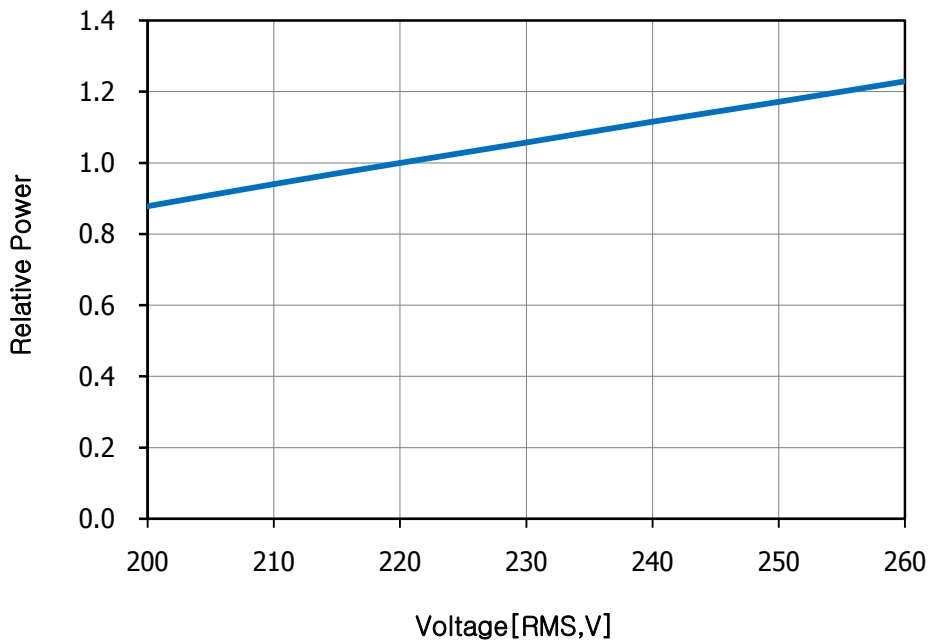
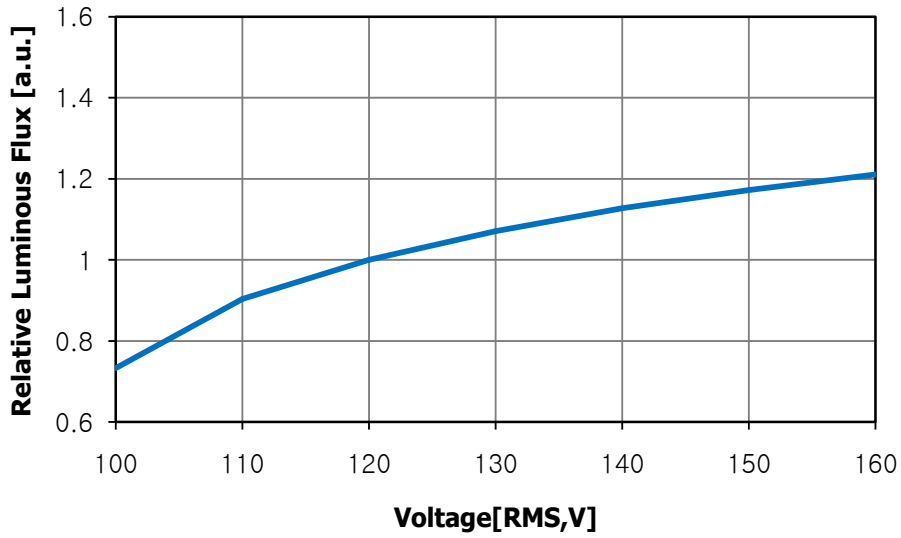
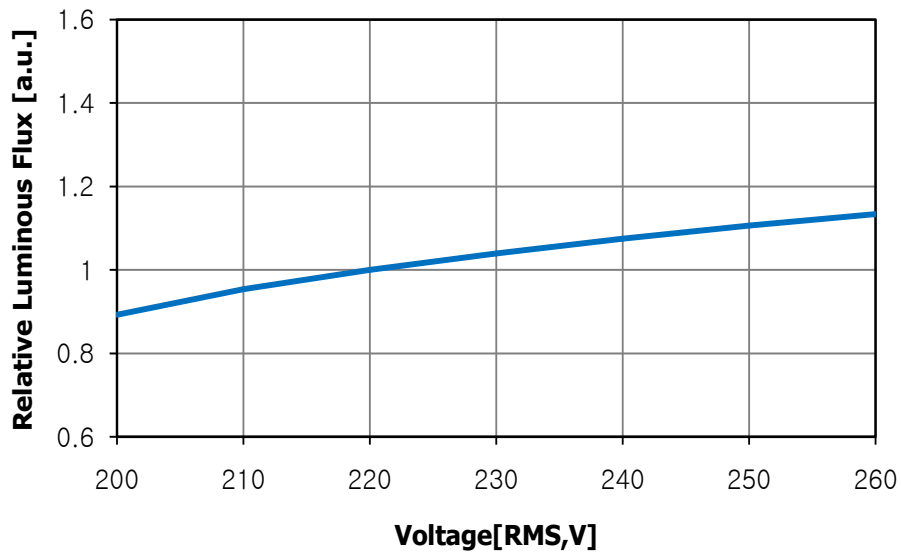

Fig 5. Relative Power Distribution vs. Voltage at  $T_a = 25^\circ\text{C}$ , 220V





## Relative Luminous Distribution

**Fig 6. Relative Luminous Flux vs. Voltage at  $T_a=25^\circ\text{C}$ , 120V**

**Fig 7. Relative Luminous Flux vs. Voltage at  $T_a=25^\circ\text{C}$ , 220V**

## Luminous Flux Characteristics

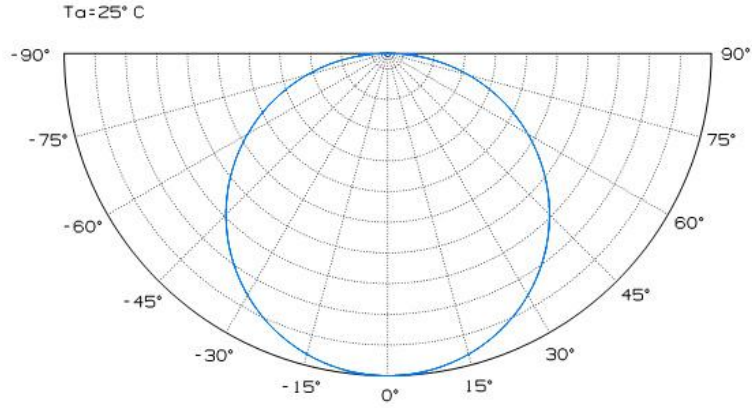
Fig 8. Radiant Pattern,  $T_a = 25^\circ\text{C}$



## Color Bin Structure

### CIE Chromaticity Diagram

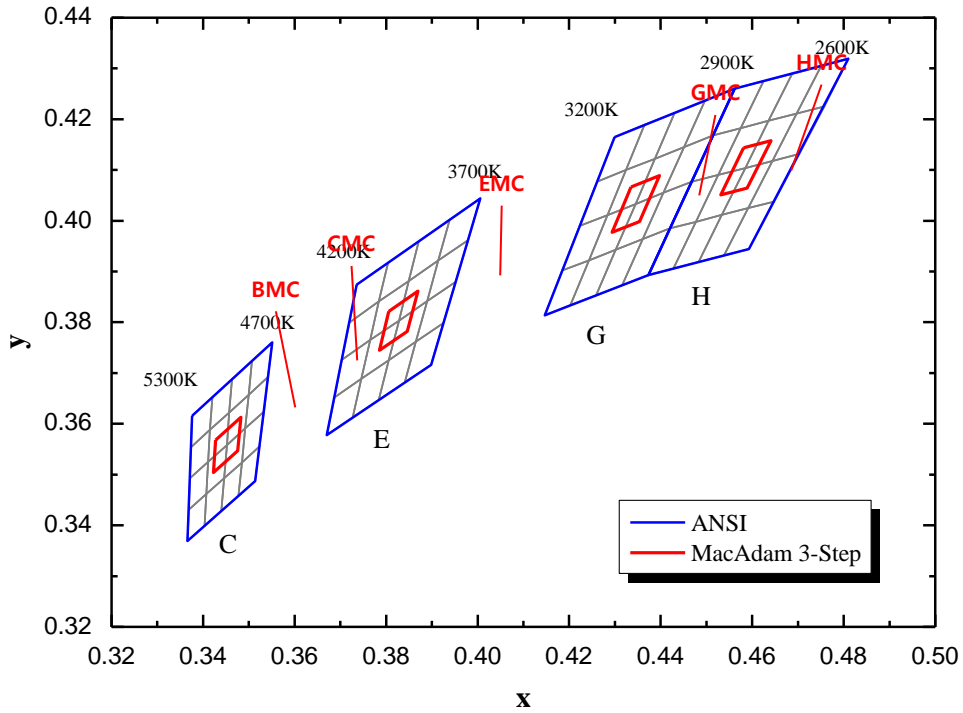

Bin	x	y	Bin	x	y	Bin	x	y
<b>BMC</b>	0.3266	0.3428	<b>CMC</b>	0.3427	0.3568	<b>EMC</b>	0.3806	0.3822
	0.3268	0.3371		0.3423	0.3504		0.3786	0.3745
	0.3319	0.3416		0.3476	0.3547		0.3846	0.3782
	0.3319	0.3476		0.3482	0.3613		0.3870	0.3861
<b>GMC</b>	0.4336	0.4067	<b>HMC</b>	0.4581	0.4143			
	0.4294	0.3977		0.4531	0.4051			
	0.4354	0.3999		0.4589	0.4065			
	0.4398	0.4089		0.4641	0.4157			

## Color Bin Structure

CIE Chromaticity Diagram

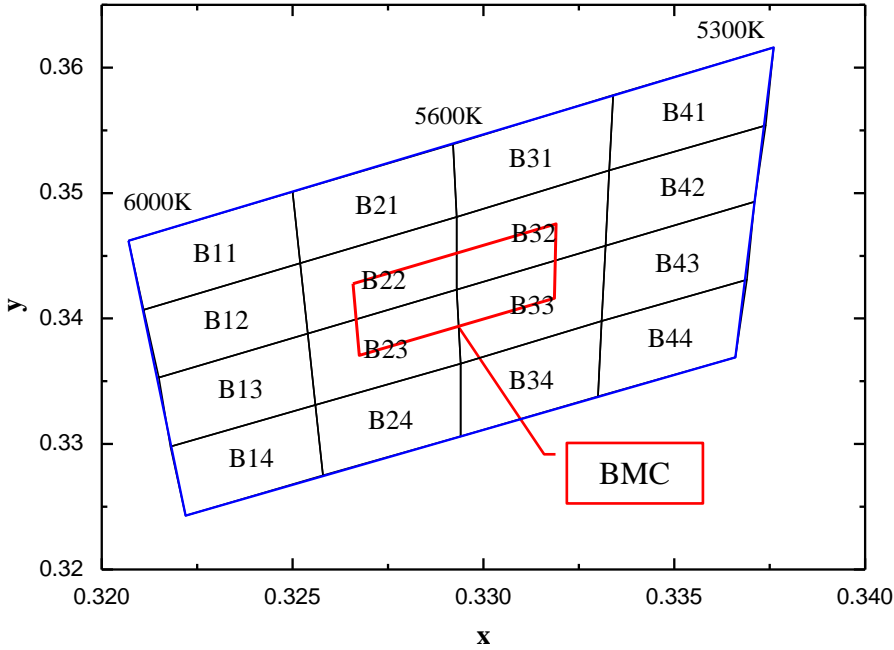

Bin	x	y	Bin	x	y	Bin	x	y	Bin	x	y
B11	0.3207	0.3462	B21	0.3250	0.3501	B31	0.3292	0.3539	B41	0.3334	0.3578
	0.3211	0.3407		0.3252	0.3444		0.3293	0.3481		0.3333	0.3518
	0.3252	0.3444		0.3293	0.3481		0.3333	0.3518		0.3374	0.3554
	0.3250	0.3501		0.3292	0.3539		0.3334	0.3578		0.3376	0.3616
B12	0.3211	0.3407	B22	0.3252	0.3444	B32	0.3293	0.3481	B42	0.3333	0.3518
	0.3215	0.3353		0.3254	0.3388		0.3293	0.3423		0.3332	0.3458
	0.3254	0.3388		0.3293	0.3423		0.3332	0.3458		0.3371	0.3493
	0.3252	0.3444		0.3293	0.3481		0.3333	0.3518		0.3374	0.3554
B13	0.3215	0.3353	B23	0.3254	0.3388	B33	0.3293	0.3423	B43	0.3332	0.3458
	0.3218	0.3298		0.3256	0.3331		0.3294	0.3364		0.3331	0.3398
	0.3256	0.3331		0.3294	0.3364		0.3331	0.3398		0.3369	0.3431
	0.3254	0.3388		0.3293	0.3423		0.3332	0.3458		0.3371	0.3493
B14	0.3218	0.3298	B24	0.3256	0.3331	B34	0.3294	0.3364	B44	0.3331	0.3398
	0.3222	0.3243		0.3258	0.3275		0.3294	0.3306		0.3330	0.3338
	0.3258	0.3275		0.3294	0.3306		0.3330	0.3338		0.3366	0.3369
	0.3256	0.3331		0.3294	0.3364		0.3331	0.3398		0.3369	0.3431

## Color Bin Structure

CIE Chromaticity Diagram

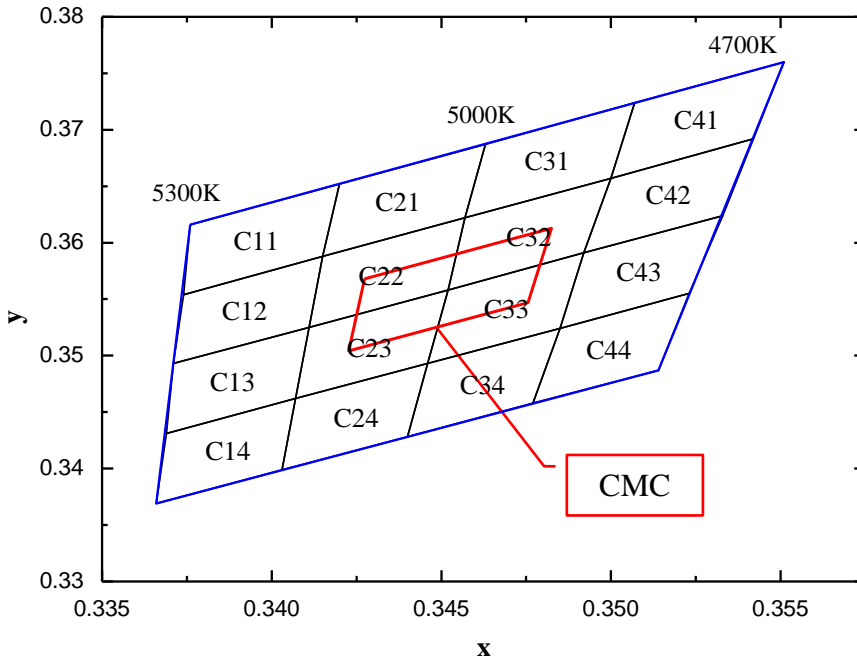

Bin	x	y	Bin	x	y	Bin	x	y	Bin	x	y
C11	0.3376	0.3616	C21	0.3420	0.3652	C31	0.3463	0.3687	C41	0.3507	0.3724
	0.3374	0.3554		0.3415	0.3588		0.3457	0.3622		0.3500	0.3657
	0.3415	0.3588		0.3457	0.3622		0.3500	0.3657		0.3542	0.3692
	0.3420	0.3652		0.3463	0.3687		0.3507	0.3724		0.3551	0.3760
C12	0.3374	0.3554	C22	0.3415	0.3588	C32	0.3457	0.3622	C42	0.3500	0.3657
	0.3371	0.3493		0.3411	0.3525		0.3452	0.3558		0.3492	0.3591
	0.3411	0.3525		0.3452	0.3558		0.3492	0.3591		0.3533	0.3624
	0.3415	0.3588		0.3457	0.3622		0.3500	0.3657		0.3542	0.3692
C13	0.3371	0.3493	C23	0.3411	0.3525	C33	0.3452	0.3558	C43	0.3492	0.3591
	0.3369	0.3431		0.3407	0.3462		0.3446	0.3493		0.3485	0.3524
	0.3407	0.3462		0.3446	0.3493		0.3485	0.3524		0.3523	0.3555
	0.3411	0.3525		0.3452	0.3558		0.3492	0.3591		0.3533	0.3624
C14	0.3369	0.3431	C24	0.3407	0.3462	C34	0.3446	0.3493	C44	0.3485	0.3524
	0.3366	0.3369		0.3403	0.3399		0.3440	0.3428		0.3477	0.3458
	0.3403	0.3399		0.3440	0.3428		0.3477	0.3458		0.3514	0.3487
	0.3407	0.3462		0.3446	0.3493		0.3485	0.3524		0.3523	0.3555

## Color Bin Structure

CIE Chromaticity Diagram

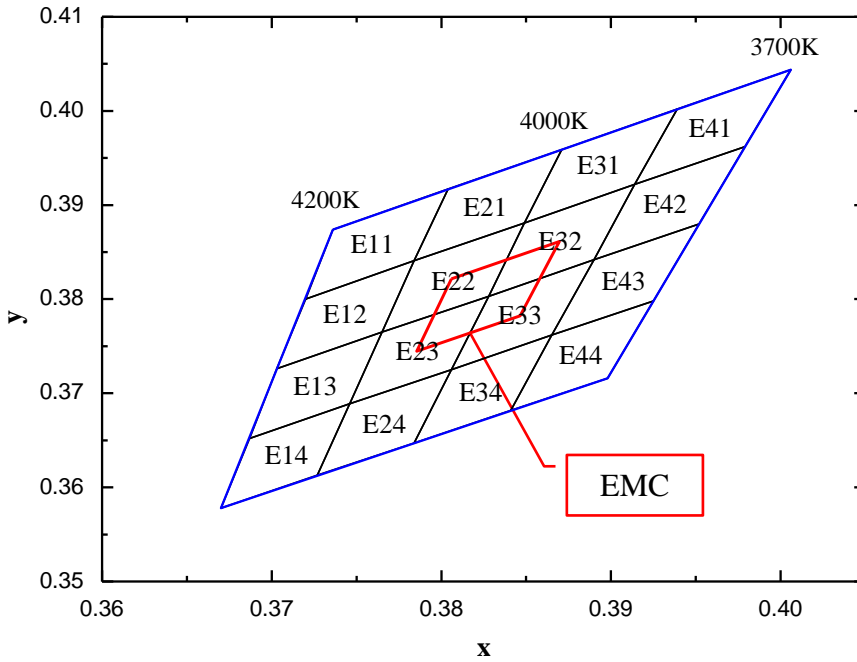

Bin	x	y	Bin	x	y	Bin	x	y	Bin	x	y
E11	0.3736	0.3874	E21	0.3804	0.3917	E31	0.3871	0.3959	E41	0.3939	0.4002
	0.3720	0.3800		0.3784	0.3841		0.3849	0.3881		0.3914	0.3922
	0.3784	0.3841		0.3849	0.3881		0.3914	0.3922		0.3979	0.3962
	0.3804	0.3917		0.3871	0.3959		0.3939	0.4002		0.4006	0.4044
E12	0.3720	0.3800	E22	0.3784	0.3841	E32	0.3849	0.3881	E42	0.3914	0.3922
	0.3703	0.3726		0.3765	0.3765		0.3828	0.3803		0.3890	0.3842
	0.3765	0.3765		0.3828	0.3803		0.3890	0.3842		0.3952	0.3880
	0.3784	0.3841		0.3849	0.3881		0.3914	0.3922		0.3979	0.3962
E13	0.3703	0.3726	E23	0.3765	0.3765	E33	0.3828	0.3803	E43	0.3890	0.3842
	0.3687	0.3652		0.3746	0.3689		0.3806	0.3725		0.3865	0.3762
	0.3746	0.3689		0.3806	0.3725		0.3865	0.3762		0.3925	0.3798
	0.3765	0.3765		0.3828	0.3803		0.3890	0.3842		0.3952	0.3880
E14	0.3687	0.3652	E24	0.3746	0.3689	E34	0.3806	0.3725	E44	0.3865	0.3762
	0.3670	0.3578		0.3727	0.3613		0.3784	0.3647		0.3841	0.3682
	0.3727	0.3613		0.3784	0.3647		0.3841	0.3682		0.3898	0.3716
	0.3746	0.3689		0.3806	0.3725		0.3865	0.3762		0.3925	0.3798

## Color Bin Structure

CIE Chromaticity Diagram

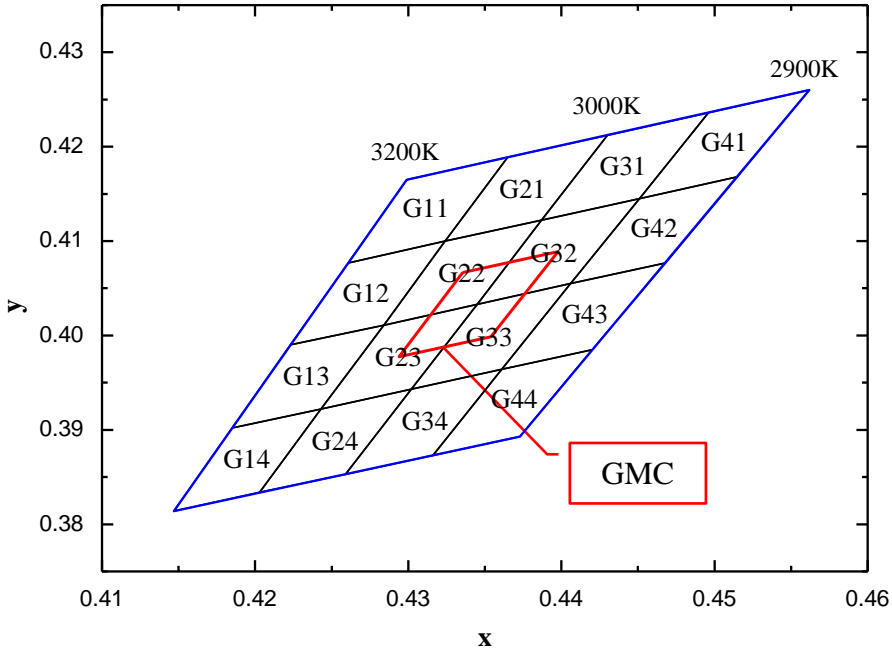

Bin	x	y	Bin	x	y	Bin	x	y	Bin	x	y
<b>G11</b>	0.4299	0.4165	<b>G21</b>	0.4364	0.4188	<b>G31</b>	0.4430	0.4212	<b>G41</b>	0.4496	0.4236
	0.4261	0.4077		0.4324	0.4099		0.4387	0.4122		0.4451	0.4145
	0.4324	0.4100		0.4387	0.4122		0.4451	0.4145		0.4514	0.4168
	0.4365	0.4189		0.4430	0.4212		0.4496	0.4236		0.4562	0.4260
<b>G12</b>	0.4261	0.4077	<b>G22</b>	0.4324	0.4100	<b>G32</b>	0.4387	0.4122	<b>G42</b>	0.4451	0.4145
	0.4223	0.3990		0.4284	0.4011		0.4345	0.4033		0.4406	0.4055
	0.4284	0.4011		0.4345	0.4033		0.4406	0.4055		0.4468	0.4077
	0.4324	0.4100		0.4387	0.4122		0.4451	0.4145		0.4515	0.4168
<b>G13</b>	0.4223	0.3990	<b>G23</b>	0.4284	0.4011	<b>G33</b>	0.4345	0.4033	<b>G43</b>	0.4406	0.4055
	0.4185	0.3902		0.4243	0.3922		0.4302	0.3943		0.4361	0.3964
	0.4243	0.3922		0.4302	0.3943		0.4361	0.3964		0.4420	0.3985
	0.4284	0.4011		0.4345	0.4033		0.4406	0.4055		0.4468	0.4077
<b>G14</b>	0.4243	0.3922	<b>G24</b>	0.4302	0.3943	<b>G34</b>	0.4302	0.3943	<b>G44</b>	0.4361	0.3964
	0.4203	0.3834		0.4259	0.3853		0.4259	0.3853		0.4316	0.3873
	0.4147	0.3814		0.4203	0.3834		0.4316	0.3873		0.4373	0.3893
	0.4185	0.3902		0.4243	0.3922		0.4361	0.3964		0.4420	0.3985

# Color Bin Structure

CIE Chromaticity Diagram

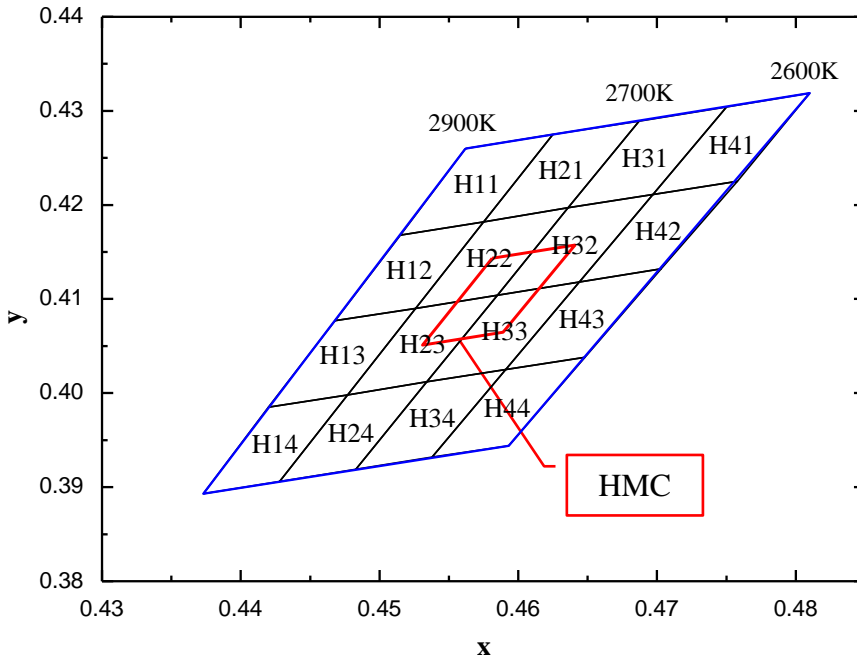

Bin	x	y	Bin	x	y	Bin	x	y	Bin	x	y
H11	0.4562	0.4260	H21	0.4625	0.4275	H31	0.4687	0.4289	H41	0.4750	0.4304
	0.4515	0.4168		0.4575	0.4182		0.4636	0.4197		0.4697	0.4211
	0.4575	0.4182		0.4636	0.4197		0.4697	0.4211		0.4758	0.4225
	0.4625	0.4275		0.4687	0.4289		0.4750	0.4304		0.4810	0.4319
H12	0.4515	0.4168	H22	0.4575	0.4182	H32	0.4636	0.4197	H42	0.4697	0.4211
	0.4468	0.4077		0.4526	0.4090		0.4585	0.4104		0.4644	0.4118
	0.4526	0.4090		0.4585	0.4104		0.4644	0.4118		0.4703	0.4132
	0.4575	0.4182		0.4636	0.4197		0.4697	0.4211		0.4758	0.4225
H13	0.4468	0.4077	H23	0.4526	0.4090	H33	0.4585	0.4104	H43	0.4644	0.4118
	0.4420	0.3985		0.4477	0.3998		0.4534	0.4012		0.4591	0.4025
	0.4477	0.3998		0.4534	0.4012		0.4591	0.4025		0.4648	0.4038
	0.4526	0.4090		0.4585	0.4104		0.4644	0.4118		0.4703	0.4132
H14	0.4420	0.3985	H24	0.4477	0.3998	H34	0.4534	0.4012	H44	0.4591	0.4025
	0.4373	0.3893		0.4428	0.3906		0.4483	0.3919		0.4538	0.3932
	0.4428	0.3906		0.4483	0.3919		0.4538	0.3932		0.4593	0.3944
	0.4477	0.3998		0.4534	0.4012		0.4591	0.4025		0.4648	0.4038



## Part List

**Table 5. Part List**

No	Part	Reference	Specification	Quantity
1	PCB	-	Al, ø100, T=1.6, 1 layer / Cu 1oz / White PSR	1
2	LED	-	SAW8KG0B	42
3	IC	U1	DT3001B	1
4	Fuse	F1	250V, 1A	1
5	Varistor	V1	275Vac	1
6	Bridge Diode	BD1	600V, 1A	1
7	TVS	Z1	440V, 600W, 5%, Unidirectional	1
8		R1, R2	R6432, 91Ω, 5%(J)	2
9	Resistor	R3	R1608, 4.32kΩ, 1%(F) @120Vac	1
			R1608, 1.74kΩ, 1%(F) @220Vac	1
			R1608, 1kΩ, 5%(J)	1
10		R4	R1608, 1kΩ, 5%(J)	1
11		R5	R3216, 0Ω, 5%(J) @120Vac	-
			R3216, 0Ω, 5%(J) @220Vac	1

## Mechanical Dimensions

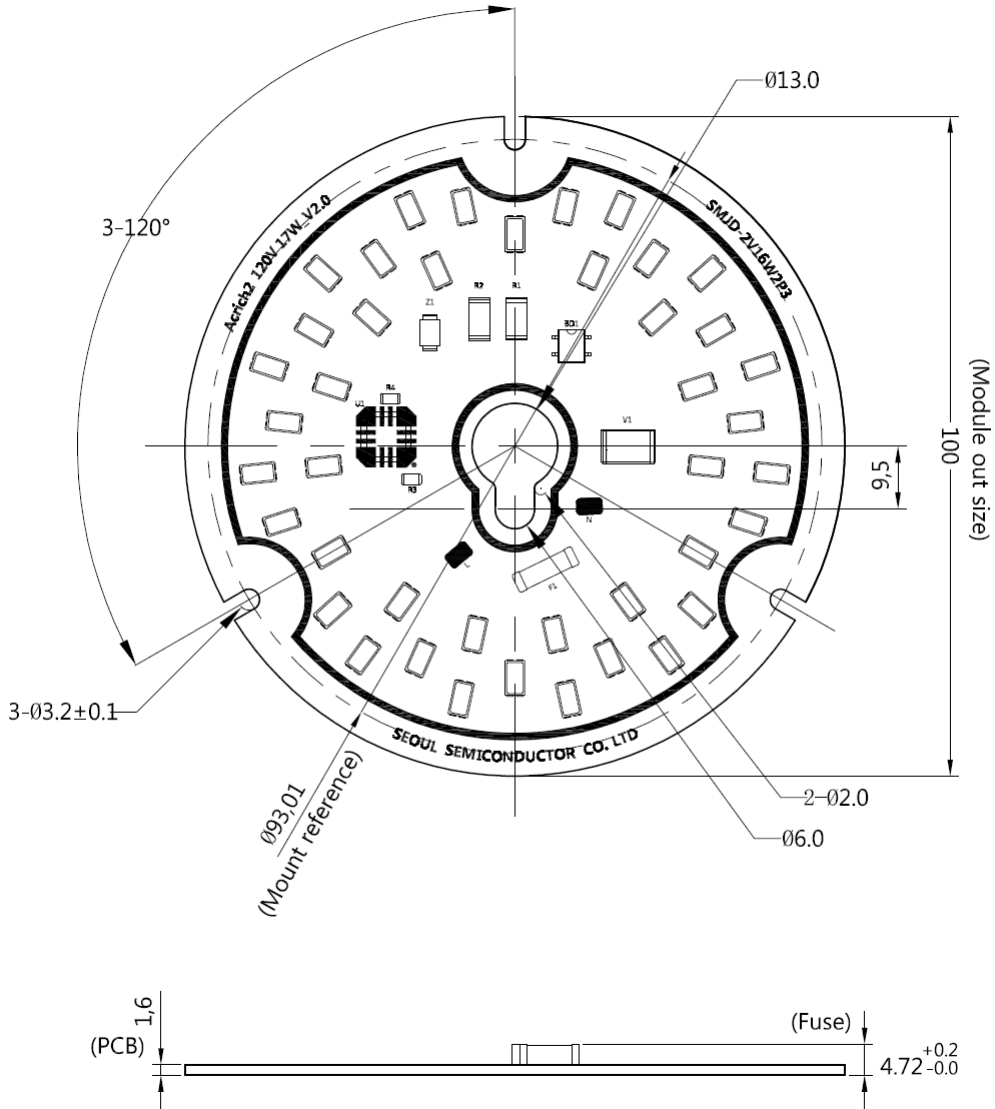

**Notes :**

- (1) All dimensions are in millimeters. (Tolerance :  $\pm 0.2$ )
- (2) Scale : None

## Circuit Drawing

### Surge Protection Circuit (SPC)

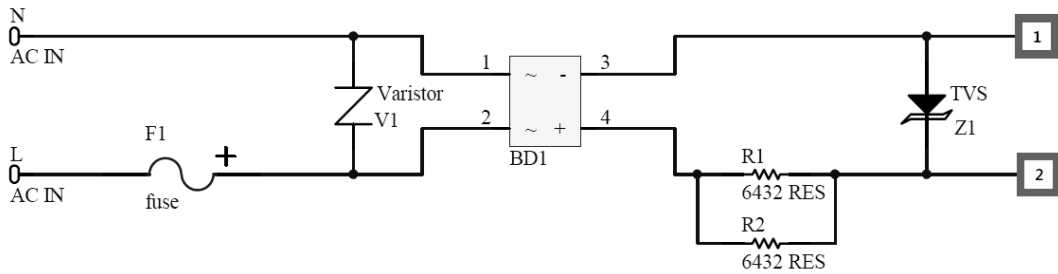

### SMJD-2V16W2P3 (120V)

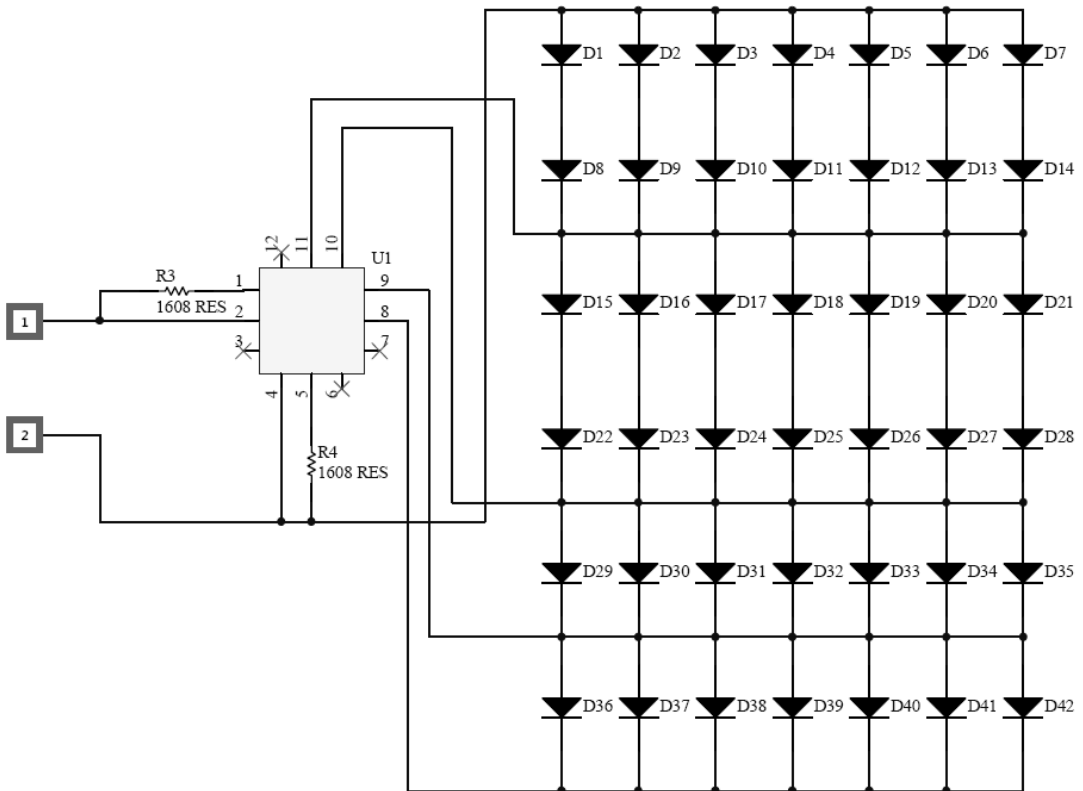

## Circuit Drawing

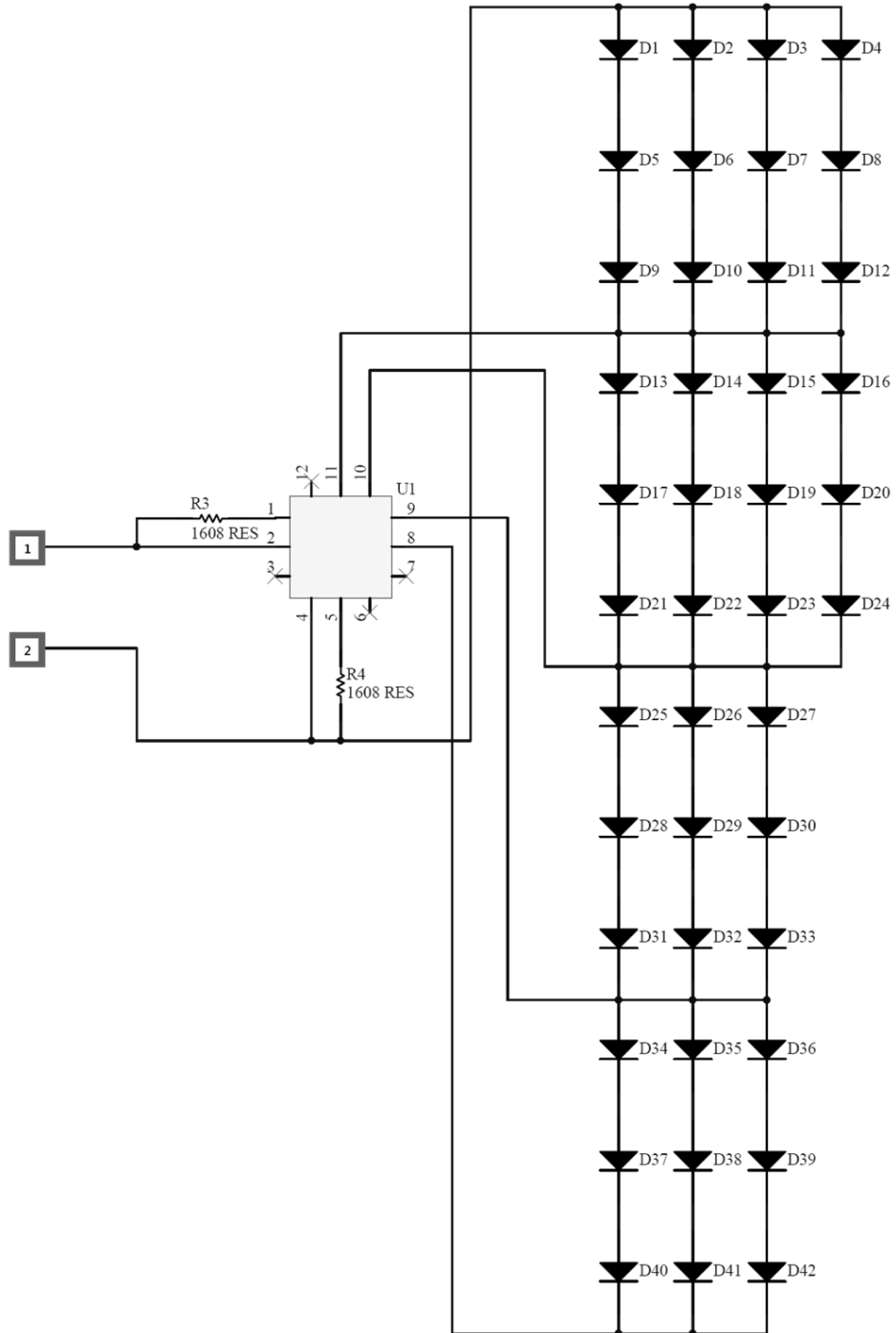
**SMJD-3V16W2P3 (220V)**

## Marking Information

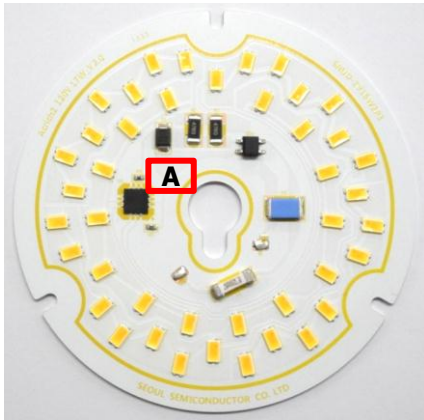

### (1) Single Bin

**A :**     ex) 140101  
              Z4G32

- Description

<u><b>1 4 0 1 0 1</b></u>	① SMT Date (YYMMDD, 6 Digits)
①	② LED PKG. Luminous Intensity Bin (2 Digits)
<u><b>Z 4 G 3 2</b></u>	③ LED PKG. Color Bin (3 Digits)
②   ③	

**A : Marking**

### (2) Combination Bin

**A :**     ex) 140101  
              17bG11

- Description

<u><b>1 4 0 1 0 1</b></u>	
①	
<b>1 7 b G 1 1</b>	
②	⑤
③	④
④	

- ① SMT Date (YYMMDD, 6 Digits)
- ② Module Flux Bin (3 Digits)
- ③ CCT (1 Digit)
- ④ CCT Combination NO. (1 Digit)
- ⑤ VF Combination NO. (1 Digit)

② Module Flux Bin				③ CCT				④ CCT Combination			⑤ VF Combination		
Mark	Min.	Typ.	Max.	Mark	Min.	Typ.	Max.	Mark	Bin1	Bin2	Mark	Bin1	Bin2
				<b>C</b>	4700	5000	5300	<b>0</b>	22	33	<b>1</b>	A	A
				<b>E</b>	3700	4000	4200	<b>1</b>	23	32	<b>2</b>	A	B
				<b>G</b>	2900	3000	3200	<b>2</b>	33	22	<b>3</b>	B	A
				<b>H</b>	2600	2700	2900	<b>3</b>	32	23	<b>4</b>	A	C
								<b>4</b>	MC	MC	<b>5</b>	C	A
											<b>6</b>	B	B
											<b>7</b>	B	C
											<b>8</b>	C	B
											<b>9</b>	C	C

## Packing

### 1. Tray information

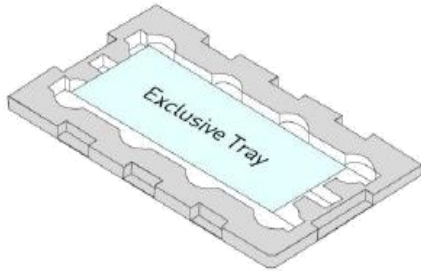

- 8 PCS LED modules packed per tray

### 2. Tray stack and taping

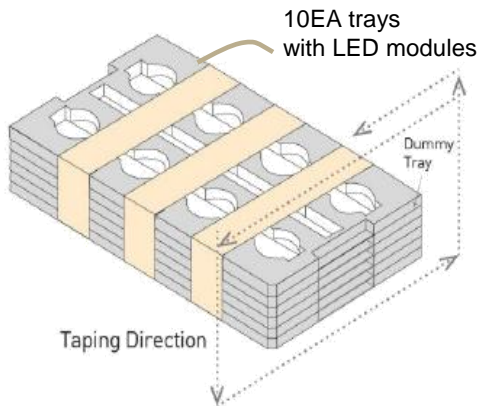

- 10 LED module trays and additional 2 dummy trays each up and down of box
- Add silica gel (1EA) on top of the tray

### 3. Sealing packing

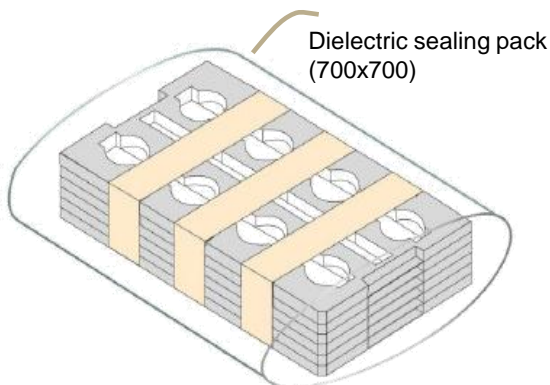

### 4. Box information & packing

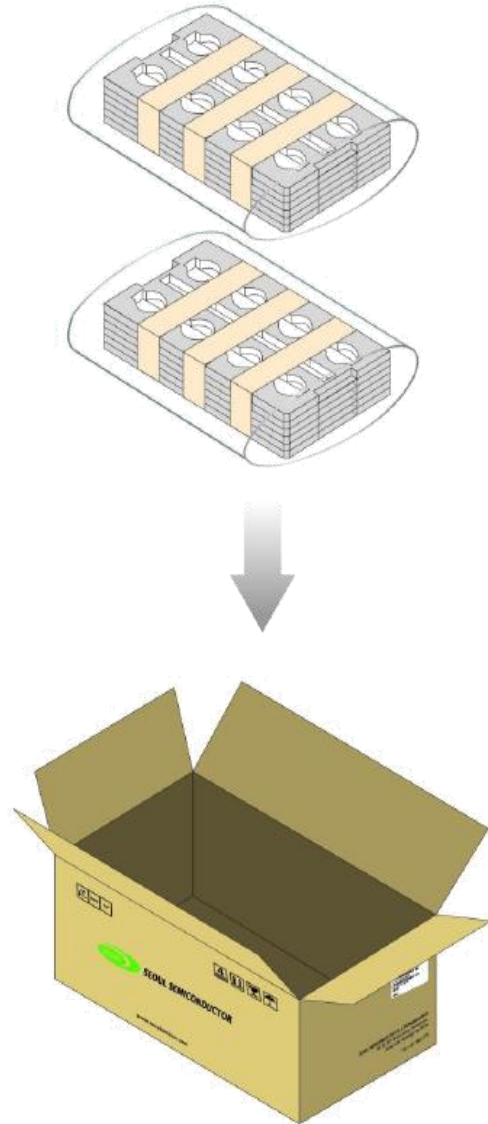

- 160 PCS modules per BOX 1EA



\*\* 1 Box : 8 PCS per tray x 20 trays = 160 PCS

## Label Information

<b>Model No.</b>	<b>SMJD-XV16W2P3 <sup>(1)</sup></b> 
<b>Rank</b>	<b>XXXXXXXX <sup>(2)</sup></b> 
<b>Type</b>	<b>STD / 3-Step <sup>(3)</sup></b>
<b>Quantity</b>	<b>XX</b> 
<b>Lot No.</b>	<b>YYMDDXXXXX-XXXXXXXX</b> 
	<b>SEOUL SEMICONDUCTOR CO.,LTD.</b>

**Notes**

- (1) The model number designation is explained as follow  
 SMJD : Seoul Semiconductor internal code  
 XV : Input Voltage (2V = 120V, 3V = 220V)  
 16W : About Power Consumption  
 2 : Acrich IC Version  
 P3 : MJT PKG (SAW8KG0B)
- (2) It represents the LED module rank.  
 ALL : Single Bin, 17a/17b : Combination Bin  
 X06/X16 : Each Sub-Bin NO. (X = CCT)  
 A : Single Bin, M : Combination Bin(3-Step)
- (3) It represents single bin(STD) or MacAdam 3-Step(3-Step).
- (4) It is attached to the top of a sealing pack & the bottom right corner of the box.

<b>TOTAL Quantity</b>  <b>XX</b>
 <b>SEOUL SEMICONDUCTOR CO.,LTD.</b>

**Notes**

- (1) It is attached to the bottom right corner of the box.

## Handling of Silicone Resin for LEDs

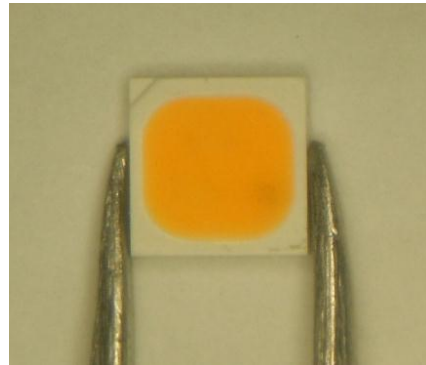
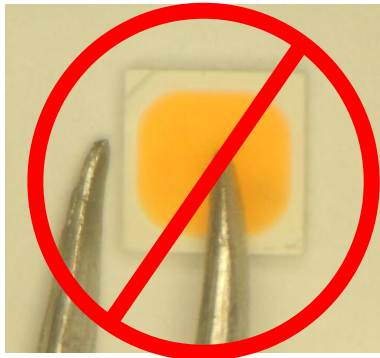

- (1) Acrich2 series is encapsulated with silicone resin for high optical efficiency.
- (2) Please do not touch the silicone resin area with sharp objects such as pincette(tweezers).
- (3) Finger prints on silicone resin area may affect the performance.
- (4) Please store LEDs in covered containers to prevent dust accumulation as this may affect performance.
- (5) Excessive force more than 3000gf to the silicone lens can result in fatal or permanent damage with LEDs.
- (6) Please do not cover the silicone resin area with any other resins such as epoxy, urethane, etc.



## Precaution for Use

- (1) Please review the Acrich2 Application Note for proper protective circuitry usage.
- (2) Please note, Acrich2 products run off of high voltage, therefore caution should be taken when working near Acrich2 products.
- (3) Make sure proper discharge prior to starting work.
- (4) DO NOT touch any of the circuit board, components or terminals with body or metal while circuit is active.
- (5) Please do not add or change wires while Acrich2 circuit is active.
- (6) Long time exposure to sunlight or UV can cause the lens to discolor.
- (7) Please do not use adhesives to attach the LED that outgas organic vapor.
- (8) Please do not use together with the materials containing Sulfur.
- (9) Please do not assemble in conditions of high moisture and/or oxidizing gas such as Cl, H<sub>2</sub>S, NH<sub>3</sub>, SO<sub>2</sub>, NO<sub>x</sub>, etc.
- (10) Please do not make any modification on module.
- (11) Please be cautious when soldering to board so as not to create a short between different trace patterns.
- (12) Do not impact or place pressure on this product because even a small amount of pressure can damage the product. The product should also not be placed in high temperatures, high humidity or direct sunlight since the device is sensitive to these conditions.
- (13) When storing devices for a long period of time before usage, please following these guidelines:
  - \* The devices should be stored in the anti-static bag that it was shipped in from Seoul-Semiconductor with opening.
  - \* If the anti-static bag has been opened, re-seal preventing air and moisture from being present in the bag.
- (14) LEDs and IC are sensitive to Electro-Static Discharge (ESD) and Electrical Over Stress (EOS). The Acrich2 product should also not be installed in end equipment without ESD protection. Below is a list of suggestions that Seoul Semiconductor purposes to minimize these effects.

### a. ESD (Electro Static Discharge)

Electrostatic discharge (ESD) is the defined as the release of static electricity when two objects come into contact. While most ESD events are considered harmless, it can be an expensive problem in many industrial environments during production and storage. The damage from ESD to an LEDs may cause the product to demonstrate unusual characteristics such as:

## Precaution for Use

- Increase in reverse leakage current lowered turn-on voltage
- Abnormal emissions from the LED at low current

The following recommendations are suggested to help minimize the potential for an ESD event. One or more recommended work area suggestions:

- Ionizing fan setup
- ESD table/shelf mat made of conductive materials
- ESD safe storage containers

One or more personnel suggestion options:

- Antistatic wrist-strap
- Antistatic material shoes
- Antistatic clothes

Environmental controls:

- Humidity control (ESD gets worse in a dry environment)

### b. EOS (Electrical Over Stress)

Electrical Over-Stress (EOS) is defined as damage that may occur when an electronic device is subjected to a current or voltage that is beyond the maximum specification limits of the device. The effects from an EOS event can be noticed through product performance like:

- Changes to the performance of the LED package  
(If the damage is around the bond pad area and since the package is completely encapsulated the package may turn on but flicker show severe performance degradation.)
- Changes to the light output of the luminaire from component failure
- Components on the board not operating at determined drive power

Failure of performance from entire fixture due to changes in circuit voltage and current across total circuit causing trickle down failures. It is impossible to predict the failure mode of every LED exposed to electrical overstress as the failure modes have been investigated to vary, but there are some common signs that will indicate an EOS event has occurred:

- Damaged may be noticed to the bond wires (appearing similar to a blown fuse)
- Damage to the bond pads located on the emission surface of the LED package  
(shadowing can be noticed around the bond pads while viewing through a microscope)
- Anomalies noticed in the encapsulation and phosphor around the bond wires
- This damage usually appears due to the thermal stress produced during the EOS event

c. To help minimize the damage from an EOS event Seoul Semiconductor recommends utilizing:

- A surge protection circuit
- An appropriately rated over voltage protection device
- A current limiting device



## Company Information

### Published by

Seoul Semiconductor © 2013 All Rights Reserved.

### Company Information

Seoul Semiconductor ([www.SeoulSemicon.com](http://www.SeoulSemicon.com)) manufactures and packages a wide selection of light emitting diodes (LEDs) for the automotive, general illumination/lighting, Home appliance, signage and back lighting markets. The company is the world's fifth largest LED supplier, holding more than 10,000 patents globally, while offering a wide range of LED technology and production capacity in areas such as "nPola", "Acrich", the world's first commercially produced AC LED, and "Acrich MJT - Multi-Junction Technology" a proprietary family of high-voltage LEDs.

The company's broad product portfolio includes a wide array of package and device choices such as Acrich and Acirch2, high-brightness LEDs, mid-power LEDs, side-view LEDs, and through-hole type LEDs as well as custom modules, displays, and sensors.

### Legal Disclaimer

Information in this document is provided in connection with Seoul Semiconductor products. With respect to any examples or hints given herein, any typical values stated herein and/or any information regarding the application of the device, Seoul Semiconductor hereby disclaims any and all warranties and liabilities of any kind, including without limitation, warranties of non-infringement of intellectual property rights of any third party. The appearance and specifications of the product can be changed to improve the quality and/or performance without notice.