

Spezifikation für Freigabe / specification for release

Kunde / customer : _____

Artikelnummer / part number : **748351024**

LF



Bezeichnung : **Bandpassfilter WE-BPF**

description : **Bandpass-Filter WE-BPF**

DATUM / DATE : 2004-10-11

A Mechanische Abmessungen / dimensions :

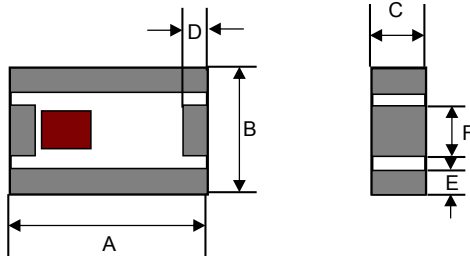

	1008	
A	2,5 ± 0,2	mm
B	2,0 ± 0,2	mm
C	0,9 ± 0,1	mm
D	0,3 ± 0,2	mm
E	0,3 ± 0,2	mm
F	0,6 ± 0,2	mm

B Elektrische Eigenschaften / electrical properties :

Eigenschaften / properties	Testbedingungen / test conditions		Wert / value	Einheit / unit	tol.
Frequenzbereich / frequency range	BW	f	2400...2500	MHz	
Einfügedämpfung / insertion loss	@ BW	IL	1,8	dB	max.
VSWR	@ BW		2,0		max.
Dämpfung I / attenuation I	880 ... 915 MHz	A	30	dB	min.
Dämpfung II / attenuation II	1710 ... 1785 MHz	A	30	dB	min.
Dämpfung III / attenuation III	1850 ... 1910 MHz	A	25	dB	min.
Dämpfung IV / attenuation IV	4800 ... 5000 MHz	A	25	dB	min.
Dämpfung V / attenuation V	7200 ... 7500 MHz	A	20	dB	min.

C Abbildung / appearance:

D Prüfgeräte / test equipment:

Agilent 8719ES

E Testbedingungen / test conditions:

Luftfeuchtigkeit / humidity: 50 ~ 70%

Umgebungstemperatur / temperature: 20°C ~ 25°C

F Werkstoffe & Zulassungen / material & approvals

Basismaterial / base material: Keramik / ceramic

Kontakt Material / contact plating: Ag + Ni + Sn

G Eigenschaften / general specifications :

Betriebstemp. / operating temperature: -40°C ~ +85°C

Lagerbedingung / storage conditions: 15°C ~ 35°C

45 ~ 75% RH

Leistung / power capacity : 500 mW max.

Freigabe erteilt / general release:	Kunde / customer		
		
Datum / date	Unterschrift / signature		
	Würth Elektronik		
		
Geprüft / checked	Kontrolliert / approved		
	AWe	Version 1	04-10-11
	Name	Änderung / modification	Datum/date

Würth Elektronik eiSos GmbH & Co.KG

D-74638 Waldenburg · Max-Eyth-Str. 1 · Germany · Telefon (+49) (0) 7942 - 945 - 0 · Telefax (+49) (0) 7942 - 945 - 400
http://www.we-online.de

Spezifikation für Freigabe / specification for release

Kunde / customer :
 Artikelnummer / part number : **748351024**
 Bezeichnung : **Bandpassfilter WE-BPF**
 description : **Bandpass-Filter WE-BPF**



DATUM / DATE : 2004-10-11

H Lötadempfehlung / solder pads:

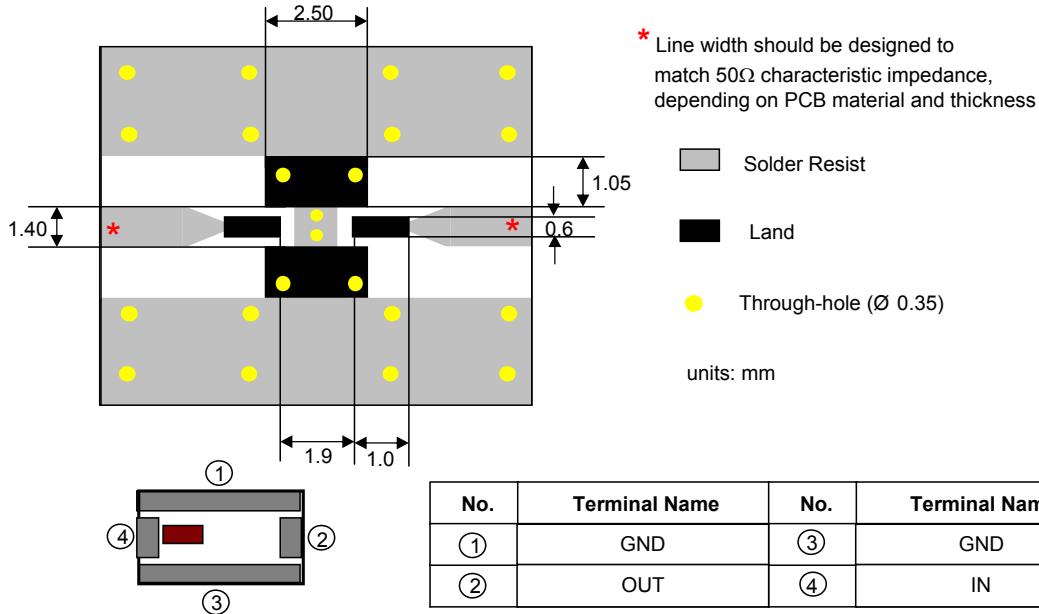

K Messdiagramm/ measuring diagram:

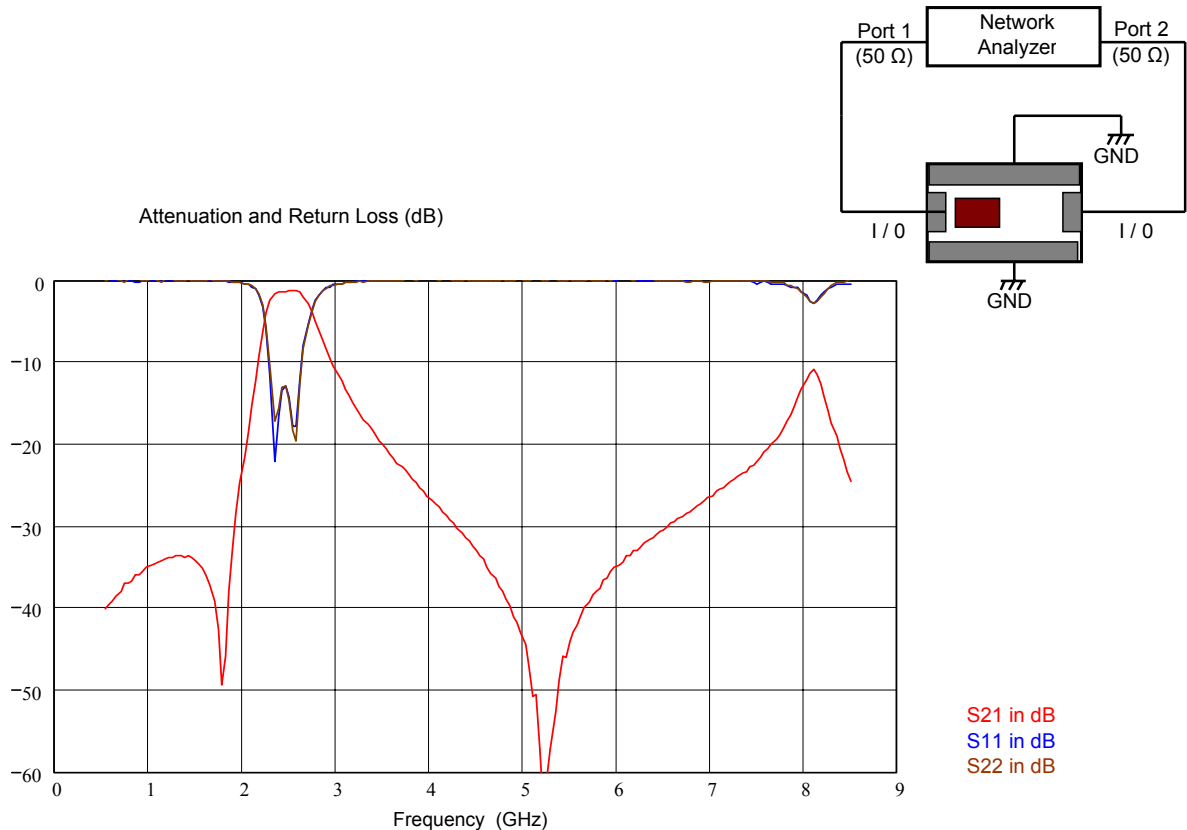

This electronic component is designed and developed with the intention for use in general electronics equipments. Before incorporating the components into any equipments in the field such as aerospace, aviation, nuclear control, submarine, transportation, (automotive control, train control, ship control), transportation signal, disaster prevention, medical, public information network etc. where higher safety and reliability are especially required or if there is possibility of direct damage or injury to human body. In addition, even electronic component in general electronic equipments, when us electrical circuits that require high safety, reliability functions or performance, the sufficient reliability evaluation-check for the safety must be performed before use. It is essential to give consideration when to install a protective circuit at the design stage

Würth Elektronik eiSos GmbH & Co.KG

D-74638 Waldenburg · Max-Eyth-Str. 1 · Germany · Telefon (+49) (0) 7942 - 945 - 0 · Telefax (+49) (0) 7942 - 945 - 400
<http://www.we-online.de>

Spezifikation für Freigabe / specification for release

Kunde / customer : _____

Artikelnummer / part number : **748351024**

LF



Bezeichnung : **Bandpassfilter WE-BPF**

description : **Bandpass-Filter WE-BPF**

DATUM / DATE : 2004-10-11

I Rollenspezifikation / tape and reel specification :

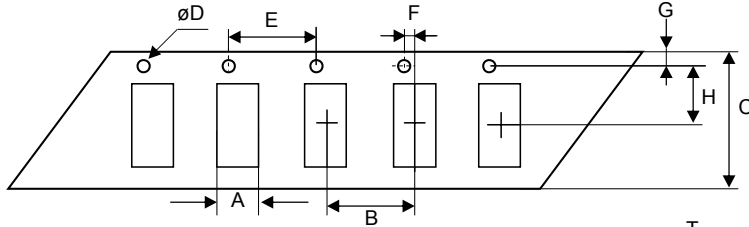

Gurtspezifikation / Tape specification:

A	2,35 ± 0,1	mm
B	4,0 ± 0,1	mm
C	8,0 ± 0,2	mm
D	1,5 +0,1/-0,0	mm
E	4,0 ± 0,1	mm
F	2,0 ± 0,1	mm
G	1,75 ± 0,1	mm
H	3,5 ± 0,1	mm
I	2,8 ± 0,1	mm
J	1,45 max.	mm
T	0,22 ± 0,05	mm

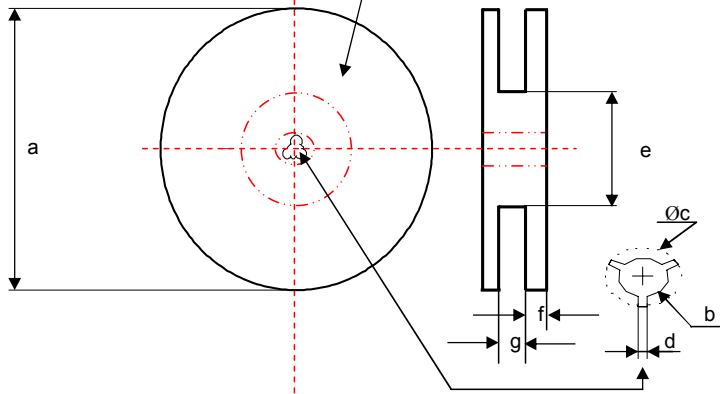

Rollenspezifikation / Reel specification:

a	178,0 ± 2,0	mm
b	13,0 ± 0,3	mm
c	21,8 ± 0,8	mm
d	2,0 ± 0,5	mm
e	60,0 ± 0,5	mm
f	1,2 ± 2,0	mm
g	9,0 ± 0,3	mm

The force for tearing off cover tape is
10 to 130 grams in arrow direction

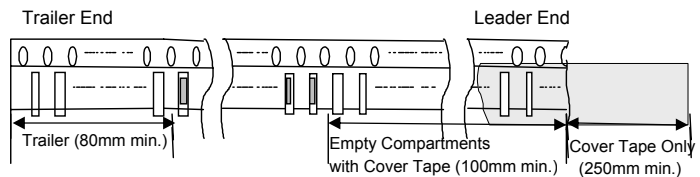
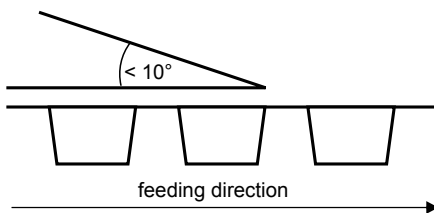

Freigabe erteilt / general release:	Kunde / customer			
	Datum / date		Unterschrift / signature	
	Würth Elektronik			
	Geprüft / checked		Kontrolliert / approved	
	AWe	Version 1		04-10-11
	Name	Änderung / modification		Datum/date

Würth Elektronik eiSos GmbH & Co.KG

D-74638 Waldenburg · Max-Eyth-Str. 1 · Germany · Telefon (+49) (0) 7942 - 945 - 0 · Telefax (+49) (0) 7942 - 945 - 400
http://www.we-online.de