

ASMW-LG00, ASMW-LM00

0.5W 2835 Surface-Mount LED

Description

The Broadcom[®] ASMW-LG00 and ASMW-LM00 surface-mount LEDs use InGaN chip technology with superior package design to enable them to produce higher light output with better flux performance. They can be driven at high current and are able to dissipate heat more efficiently resulting in better performance with higher reliability.

These LEDs operate under a wide range of environmental conditions, making them ideal for various applications, applications including fluorescent replacement, under-cabinet lighting, retail display lighting and panel lights.

To facilitate easy pick-and-place assembly, the LEDs are packed in tape and reel. Every reel is shipped in single flux and color bin to provide close uniformity.

Features

- High reliability package with enhanced silicone resin encapsulation
- Moisture sensitivity level 3
- Available in green and deep blue colors
- Low package profile and large emitting area
- Enhanced corrosion resistance

Applications

- Specialty and architectural lighting
- Gaming and vending machine backlighting
- Industrial lighting; for example, tower light
- Industrial equipment indicator

CAUTION! This LED is Class 1A ESD sensitive per ANSI/ESDA/JEDEC JS-001. Please observe appropriate precautions during handling and processing. Refer to Application Note AN-1142 for additional details.

Figure 1: Package Dimensions

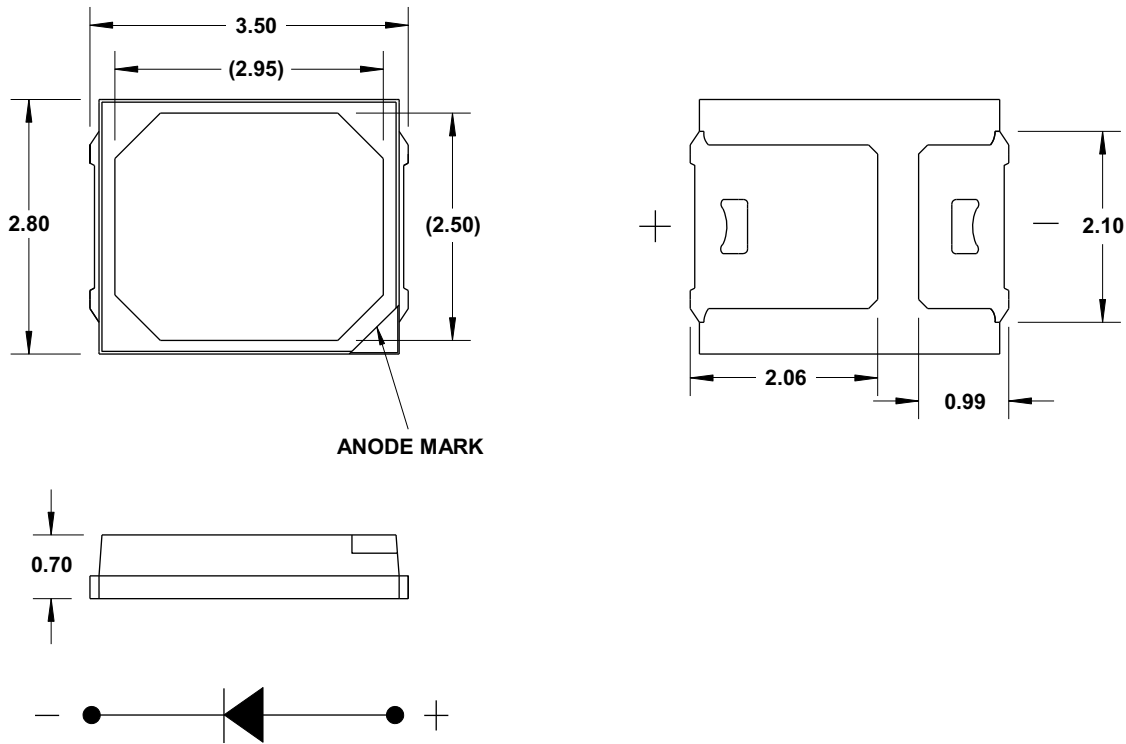

NOTE:

- All dimensions are in millimeters (inches).
- Tolerance is ± 0.20 mm unless otherwise specified.
- Encapsulation = silicone.
- Terminal finish = silver plating.
- Dimensions in brackets are for reference only.

Device Selection Guide ($T_J = 25^\circ\text{C}$, $I_F = 150$ mA)

Part Number	Color	Luminous Flux Φ_V (lm) ^{a, b}			Luminous Intensity, I_V (cd) ^c
		Min.	Typ.	Max.	Typ.
ASMW-LG00-NWY0E	Green	32.0	36.3	41.0	13.0
ASMW-LG00-NY10E	Green	38.0	43.0	47.0	15.4
ASMW-LM00-NGJ0E	Deep blue	8.0	8.6	11.0	2.7

- Luminous flux, Φ_V , is measured at the mechanical axis of the package, and it is tested with a single current pulse condition.
- Tolerance is $\pm 12\%$.
- For reference only.

Absolute Maximum Ratings

Parameter	Green/Deep Blue	Units
DC Forward Current ^a	200	mA
Peak Forward Current ^b	300	mA
Power Dissipation	740	mW
Reverse Voltage	Not designed for reverse bias operation	
LED Junction Temperature	125	°C
Operating Temperature Range	-40 to +100	°C
Storage Temperature Range	-40 to +100	°C

a. Derate linearly as shown in [Figure 10](#) and [Figure 11](#).

b. Duty factor = 10%, frequency = 1 kHz.

Optical and Electrical Characteristics (T_J = 25°C, I_F = 150 mA)

Parameter	Min.	Typ.	Max.	Units
Viewing Angle, 2θ _{1/2} ^a	—	120	—	Deg
Forward Voltage, V _F ^b				
Green	2.9	3.16	3.7	V
Deep Blue	2.9	3.08	3.7	V
Reverse Current, I _R at V _R = 4V ^c	—	—	10	μA
Dominant Wavelength, λ _d ^d				
Green	515.0	529.0	535.0	nm
Deep Blue	450.0	456.0	460.0	nm
Peak Wavelength, λ _p				
Green	—	522	—	nm
Deep Blue	—	451	—	nm
Thermal Resistance, R _{θJ-S} ^e				
Green	—	60	—	°C/W
Deep Blue	—	36	—	°C/W

a. θ_{1/2} is the off axis angle where the luminous intensity is half of the peak intensity.

b. Forward voltage tolerance = ± 0.1V.

c. Indicates production final test condition only. Long-term reverse biasing is not recommended.

d. The dominant wavelength, λ_d is derived from the CIE Chromaticity diagram and represents the color of the lamp.

e. Thermal resistance from LED junction to solder point.

Part Numbering System

A S M W - L x₁ 0 0 - N x₂ x₃ x₄ x₅

Code	Description	Option
x ₁	Color	G Green
		M Deep blue
x ₂	Minimum Flux Bin	Refer to the Flux Bin Limits (CAT) table
x ₃	Maximum Flux Bin	
x ₄	Color Bin	0 Full color distribution
x ₅	Test Option	E Test current = 150 mA

Part Number Example:

ASMW-LG00-NWY0E

- x₁ = G Green color
- x₂ = W Minimum flux bin W
- x₃ = Y Maximum flux bin Y
- x₄ = 0 Full color distribution
- x₅ = E Test current = 150 mA

Bin Information

Flux Bin Limits (CAT)

Bin ID	Luminous Flux, Φ_V (lm)	
	Min.	Max.
Green		
W	32.0	35.0
X	35.0	38.0
Y	38.0	41.0
Z	41.0	44.0
1	44.0	47.0
Deep Blue		
G	8.0	9.0
H	9.0	10.0
J	10.0	11.0

Tolerance: $\pm 12\%$

Forward Voltage Bin Limits (V_F)

Bin ID	Forward Voltage, V_F (V)	
	Min.	Max.
G04	2.9	3.0
G05	3.0	3.1
G06	3.1	3.2
G07	3.2	3.3
G08	3.3	3.4
G09	3.4	3.5
G10	3.5	3.6
G11	3.6	3.7

Tolerance: $\pm 0.1V$

Color Bin Limits (BIN)

Bin ID	Dominant Wavelength, λ_d (nm)	
	Min.	Max.
Green		
1	515.0	520.0
2	520.0	525.0
3	525.0	530.0
4	530.0	535.0
Deep Blue		
8	450.0	455.0
9	455.0	460.0

Tolerance : $\pm 1.0nm$

Example of bin information on reel and packaging label:

CAT: W Flux bin W
 BIN: 2 Color bin 2
 VF: G05 V_F bin G05

Figure 2: Spectral Power Distribution

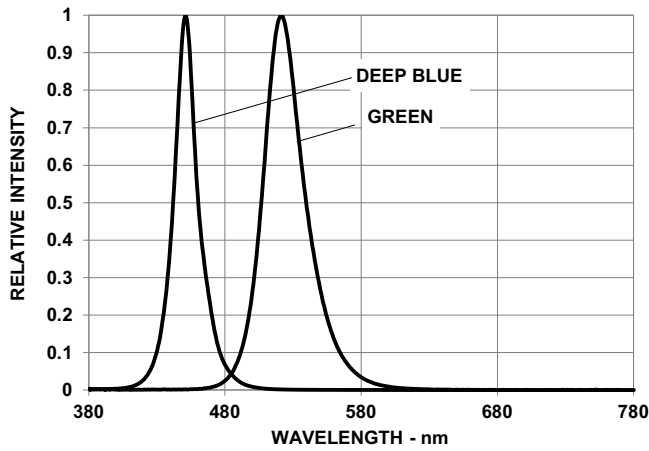

Figure 3: Forward Current vs. Forward Voltage

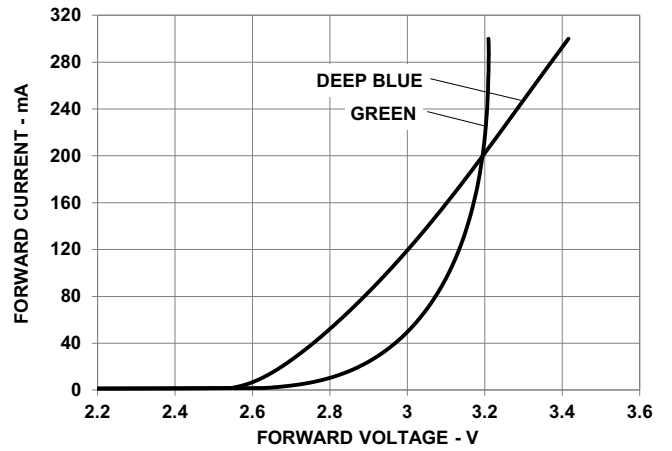

Figure 4: Relative Luminous Flux vs. Mono Pulse Current

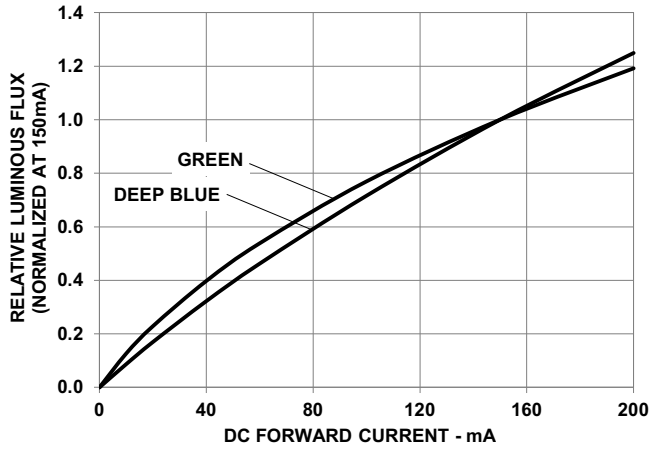

Figure 5: Radiation Pattern

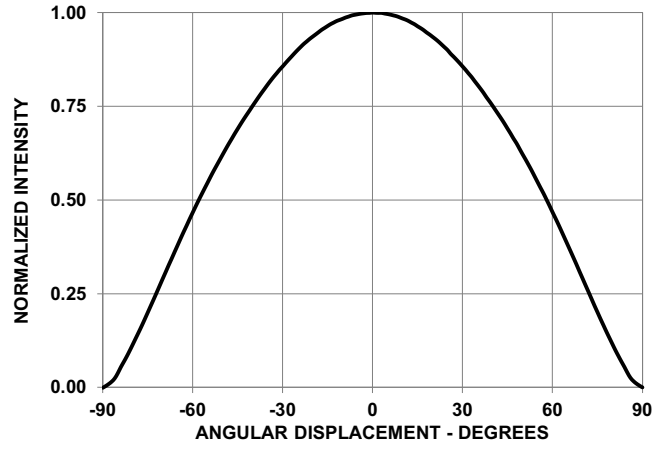

Figure 6: Dominant Wavelength Shift vs. Mono Pulse Current

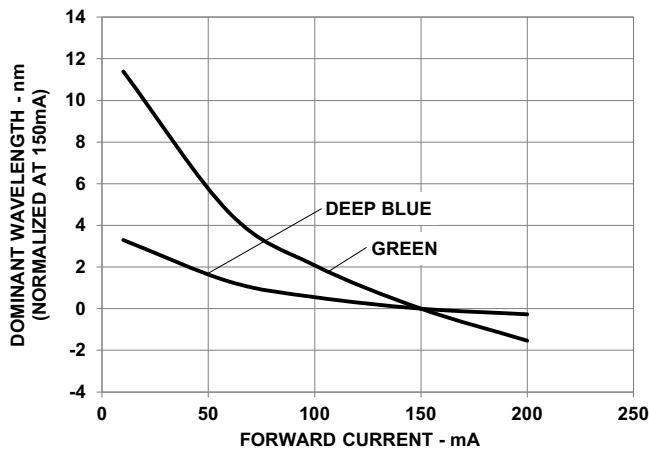

Figure 7: Forward Voltage Shift vs. Junction Temperature

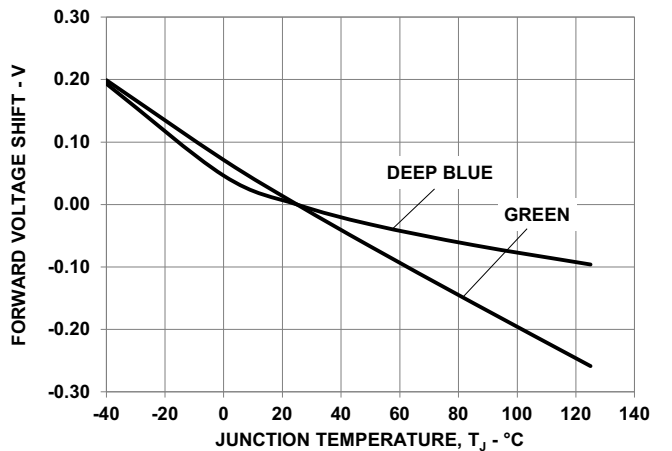

Figure 8: Relative Light Output vs. Junction Temperature

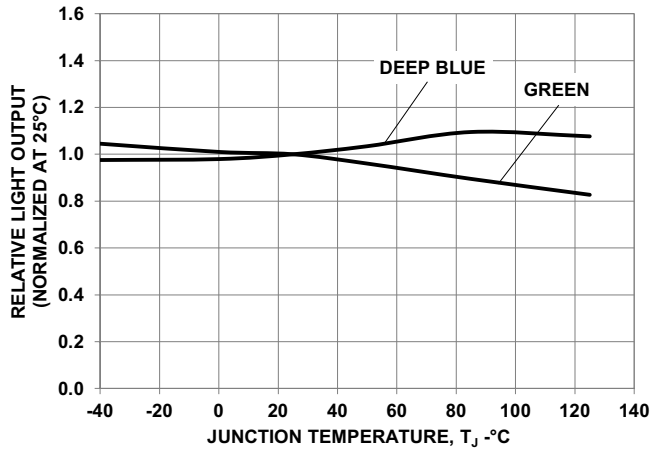

Figure 9: Dominant Wavelength Shift vs. Junction Temperature

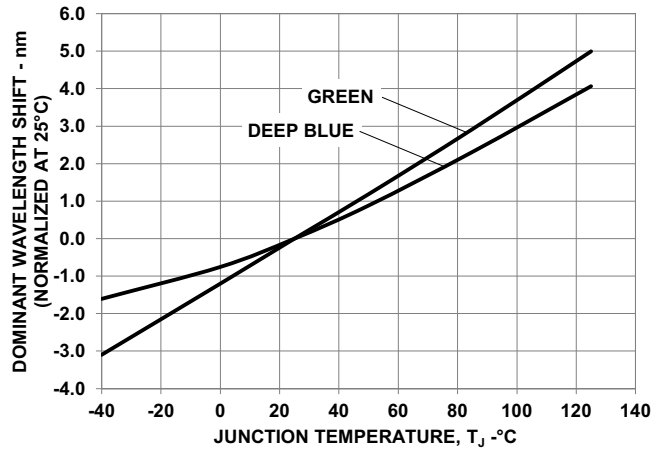

Figure 10: Maximum Forward Current vs. Ambient Temperature. Derated based on $T_{JMAX} = 125^{\circ}C$

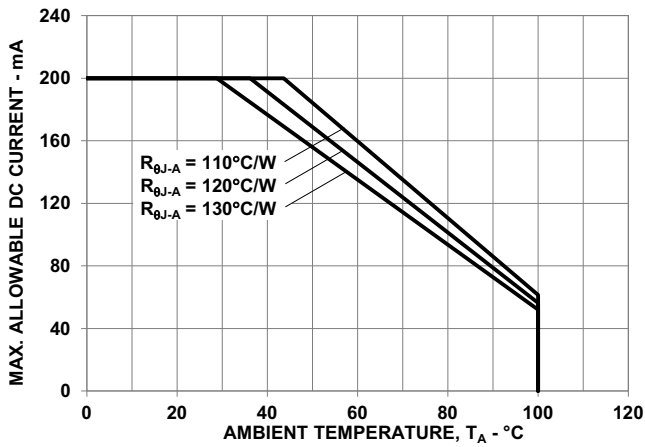

Figure 11: Maximum Forward Current vs. Solder Point Temperature. Derated based on $T_{JMAX} = 125^{\circ}C$, $R_{\theta J-S} = 60^{\circ}C/W$ (Green), $R_{\theta J-S} = 36^{\circ}C/W$ (Deep Blue)

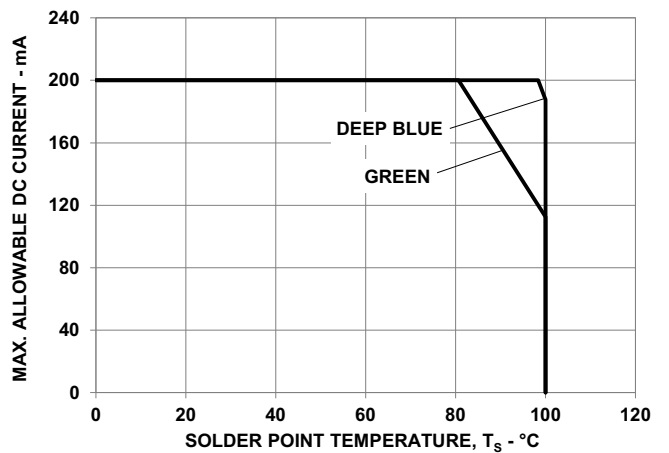

Figure 12: Pulse Handling Capability at $T_S \leq 100^{\circ}C$ (Deep Blue)

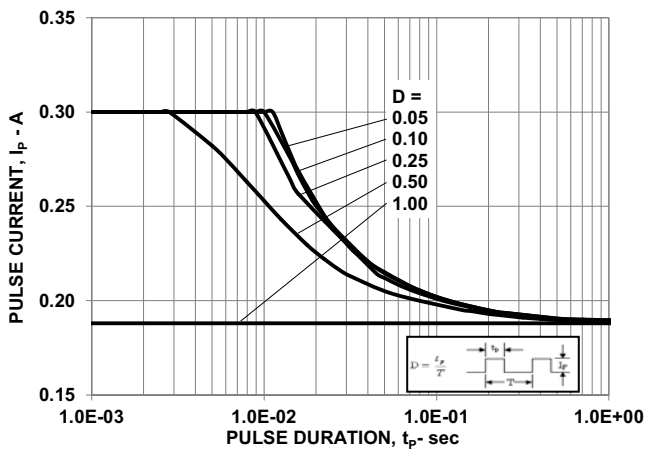

Figure 13: Pulse Handling Capability at $T_S \leq 76^{\circ}C$ (Green)

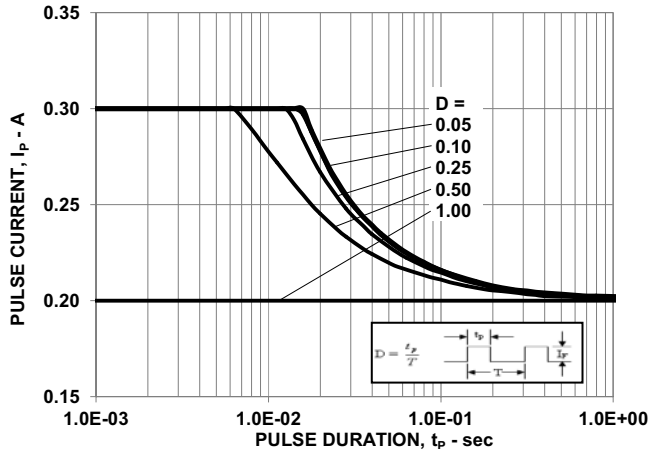

Figure 14: Pulse Handling Capability at $T_S = 100\text{ }^\circ\text{C}$ (Green)

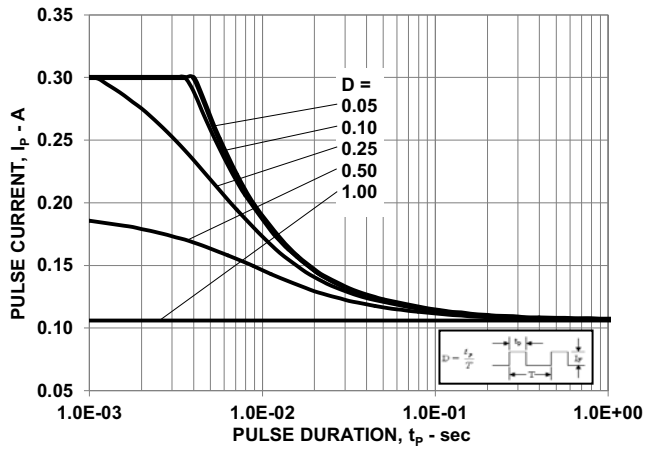
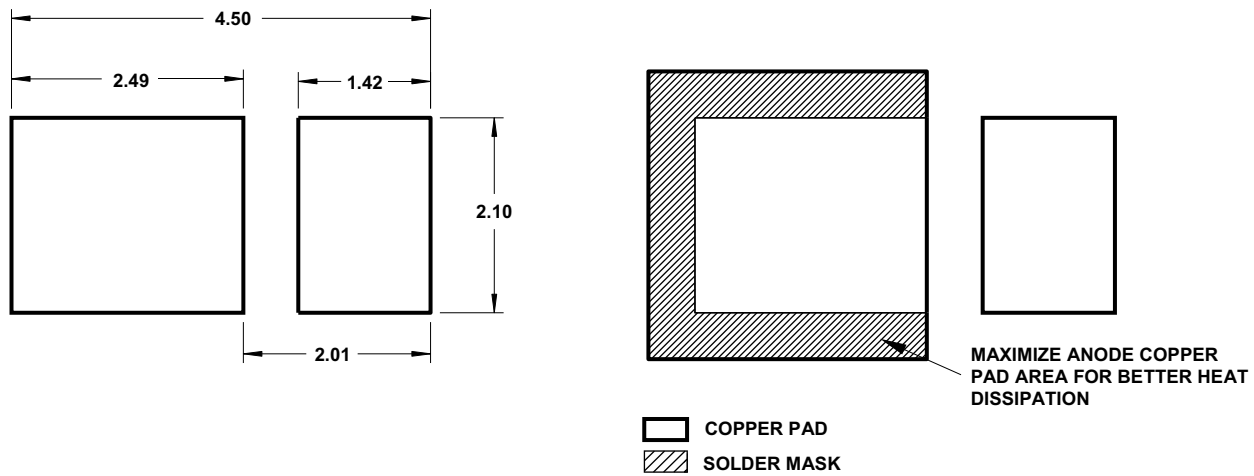
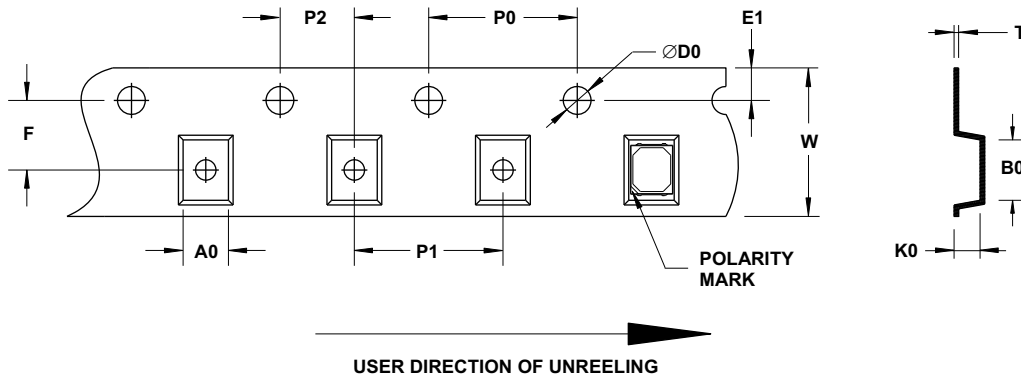

Figure 15: Recommended Soldering Land Pattern



NOTE: All dimensions are in millimeters (mm).

Figure 16: Carrier Tape Dimensions



F	P0	P1	P2	D0	E1	W	T	B0	K0	A0
3.5 ± 0.05	4.0 ± 0.1	4.0 ± 0.1	2.0 ± 0.05	1.55 ± 0.05	1.75 ± 0.1	8.0 ± 0.2	0.2 ± 0.05	3.8 ± 0.1	1.05 ± 0.1	3.1 ± 0.1

NOTE: All dimensions are in millimeters (mm).

Figure 17: Reel Dimensions

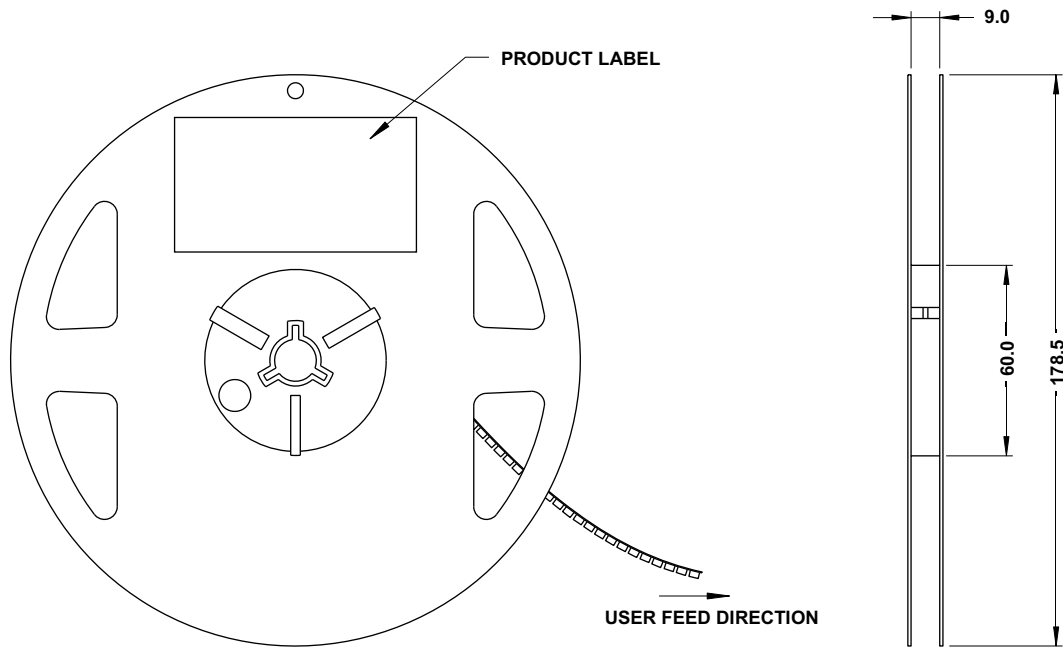

NOTE: All dimensions are in millimeters (mm).

Precautionary Notes

Soldering

- Do not perform reflow soldering more than twice. Observe necessary precautions of handling moisture-sensitive device as stated in the following section.
- Do not apply any pressure or force on the LED during reflow and after reflow when the LED is still hot.
- Use reflow soldering to solder the LED. Use hand soldering only for rework if unavoidable, but it must be strictly controlled to following conditions:
 - Soldering iron tip temperature = 315°C max.
 - Soldering duration = 3 seconds max.
 - Number of cycles = 1 only
 - Power of soldering iron = 50W max.
- Do not touch the LED package body with the soldering iron except for the soldering terminals, as it may cause damage to the LED.
- Confirm beforehand whether the functionality and performance of the LED is affected by soldering with hand soldering.

Figure 18: Recommended Lead-Free Reflow Soldering Profile

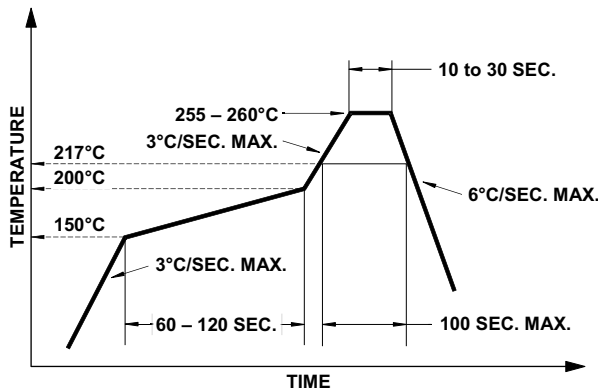
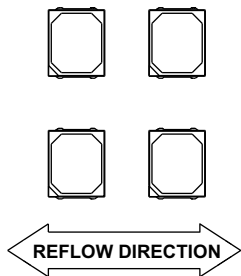

Figure 19: Recommended Board Reflow Direction



Handling Precautions

The encapsulation material of the LED is made of silicone for better product reliability. Compared to epoxy encapsulant, which is hard and brittle, silicone is softer and flexible. Observe special handling precautions during assembly of silicone encapsulated LED products. Failure to comply might lead to damage and premature failure of the LED. Refer to Broadcom Application Note AN5288, *Silicone Encapsulation for LED: Advantages and Handling Precautions*, for additional information.

- Do not poke sharp objects into the silicone encapsulant. Sharp objects, such as tweezers or syringes, might apply excessive force or even pierce through the silicone and induce failures to the LED die or wire bond.
- Do not touch the silicone encapsulant. Uncontrolled force acting on the silicone encapsulant might result in excessive stress on the wire bond. Hold the LED only by the body.
- Do not stack assembled PCBs together. Use an appropriate rack to hold the PCBs.
- Surface of silicone material attracts dust and dirt easier than epoxy due to its surface tackiness. To remove foreign particles on the surface of silicone, use a cotton bud with isopropyl alcohol (IPA). During cleaning, rub the surface gently without putting too much pressure on the silicone. Ultrasonic cleaning is not recommended.
- For automated pick and place, Broadcom has tested a nozzle size with an outer diameter of 3.5 mm to work with this LED. However, due to the possibility of variations in other parameters such as pick and place machine maker/model, and other settings of the machine, verify that the selected nozzle will not cause damage to the LED.

Handling of Moisture-Sensitive Devices

This product has a Moisture Sensitive Level 3 rating per JEDEC J-STD-020. Refer to Broadcom Application Note AN5305, *Handling of Moisture Sensitive Surface Mount Devices* for additional details and a review of proper handling procedures.

- Before use:
 - An unopened moisture barrier bag (MBB) can be stored at <40°C/90% RH for 12 months. If the actual shelf life has exceeded 12 months and the humidity

indicator card (HIC) indicates that baking is not required, then it is safe to reflow the LEDs per the original MSL rating.

- Do not open the MBB prior to assembly (for example, for IQC). If unavoidable, MBB must be properly resealed with fresh desiccant and HIC. The exposed duration must be taken in as floor life.
- Control after opening the MBB:
 - Read the HIC immediately upon opening of MBB.
 - Keep the LEDs at <30°/60%RH at all times, and complete all high temperature-related processes, including soldering, curing or rework within 168 hours.
- Control for unfinished reel:

Store unused LEDs in a sealed MBB with desiccant or a desiccator at <5% RH.
- Control of assembled boards:

If the PCB soldered with the LEDs is to be subjected to other high-temperature processes, store the PCB in a sealed MBB with desiccant or desiccator at <5% RH to ensure that all LEDs have not exceeded their floor life of 168 hours.
- Baking is required if:
 - The HIC indicator indicates a change in color for 10% and 5%, as stated on the HIC.
 - The LEDs are exposed to conditions of >30°C/60% RH at any time.
 - The LED's floor life exceeded 168 hours.

The recommended baking condition is: 60±5°C for 20 hours.

Baking can only be done once.
- Storage:

The soldering terminals of these Broadcom LEDs are silver plated. If the LEDs are exposed in ambient environment for too long, the silver plating might be oxidized, thus affecting its solderability performance. As such, keep unused LEDs in a sealed MBB with desiccant or in a desiccator at <5% RH.

Application Precautions

- The drive current of the LED must not exceed the maximum allowable limit across temperature as stated in the data sheet. Constant current driving is recommended to ensure consistent performance.
- Circuit design must cater to the whole range of forward voltage (V_F) of the LEDs to ensure the intended drive current can always be achieved.

- The LED exhibits slightly different characteristics at different drive currents, which may result in a larger variation of performance (meaning: intensity, wavelength, and forward voltage). Set the application current as close as possible to the test current to minimize these variations.
- The LED is not intended for reverse bias. Use other appropriate components for such purpose. When driving the LED in matrix form, it is crucial to ensure that the reverse bias voltage is not exceeding the allowable limit of the LED.
- This LED is designed to have enhanced gas corrosion resistance. Its performance has been tested according to the conditions below:
 - IEC 60068-2-43: 25°C/75% RH, H₂S 15 ppm, 21 days.
 - IEC 60068-2-42: 25°C/75% RH, SO₂ 25 ppm, 21 days.
 - IEC 60068-2-60: 25°C/75% RH, SO₂ 200 ppb, NO₂ 200 ppb, H₂S 10 ppb, Cl₂ 10 ppb, 21 days.
- As the actual application might not be exactly similar to the test conditions, verify that the LED will not be damaged by prolonged exposure in the intended environment.
- Avoid rapid change in ambient temperature, especially in high-humidity environments, because they cause condensation on the LED.
- If the LED is intended to be used in harsh or outdoor environment, protect the LED by means of protective cover against damages caused by rain water, water, dust, oil, corrosive gases, external mechanical stresses, and so on.

Thermal Management

The optical, electrical, and reliability characteristics of the LED are affected by temperature. Keep the junction temperature (T_J) of the LED below the allowable limit at all times. T_J can be calculated as follows:

$$T_J = T_A + R_{\theta J-A} \times I_F \times V_{Fmax}$$

where:

T_A = Ambient temperature (°C)

$R_{\theta J-A}$ = Thermal resistance from LED junction to ambient (°C/W)

I_F = Forward current (A)

V_{Fmax} = Maximum forward voltage (V)

The complication of using this formula lies in T_A and $R_{\theta J-A}$. Actual T_A is sometimes subjective and hard to determine. $R_{\theta J-A}$ varies from system to system depending on design and is usually not known.

Another way of calculating T_J is by using the solder point temperature, T_S as follows:

$$T_J = T_S + R_{\theta J-S} \times I_F \times V_{Fmax}$$

where:

T_S = LED solder point temperature as shown in the following figure ($^{\circ}\text{C}$)

$R_{\theta J-S}$ = Thermal resistance from junction to solder point ($^{\circ}\text{C}/\text{W}$)

I_F = Forward current (A)

V_{Fmax} = Maximum forward voltage (V)

Figure 20: Solder Point Temperature on PCB

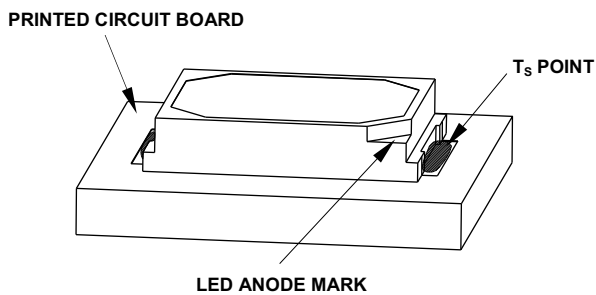

T_S can be easily measured by mounting a thermocouple on the soldering joint as shown in preceding figure, while $R_{\theta J-S}$ is provided in the data sheet. Verify the T_S of the LED in the final product to ensure that the LEDs are operating within all maximum ratings stated in the data sheet.

Eye Safety Precautions

LEDs may pose optical hazards when in operation. Do not look directly at operating LEDs because it might be harmful to the eyes. For safety reasons, use appropriate shielding or personal protective equipment

Disclaimer

Broadcom's products are not specifically designed, manufactured, or authorized for sale as parts, components, or assemblies for the planning, construction, maintenance, or direct operation of a nuclear facility or for use in medical devices or applications. The customer is solely responsible, and waives all rights to make claims against Broadcom or its suppliers, for all loss, damage, expense, or liability in connection with such use.

Broadcom, the pulse logo, Connecting everything, Avago Technologies, Avago, and the A logo are among the trademarks of Broadcom and/or its affiliates in the United States, certain other countries and/or the EU.

Copyright © 2017–2018 by Broadcom. All Rights Reserved.

The term “Broadcom” refers to Broadcom Inc. and/or its subsidiaries. For more information, please visit www.broadcom.com.

Broadcom reserves the right to make changes without further notice to any products or data herein to improve reliability, function, or design. Information furnished by Broadcom is believed to be accurate and reliable. However, Broadcom does not assume any liability arising out of the application or use of this information, nor the application or use of any product or circuit described herein, neither does it convey any license under its patent rights nor the rights of others.

