

DATE	REV	EON	APP'D. BY
1/30/06	B1	7462	JM
6-25-09	B2	8769	JM
2-14-11	B3	9128	TRM
5-23-12	B4	9477	SMN

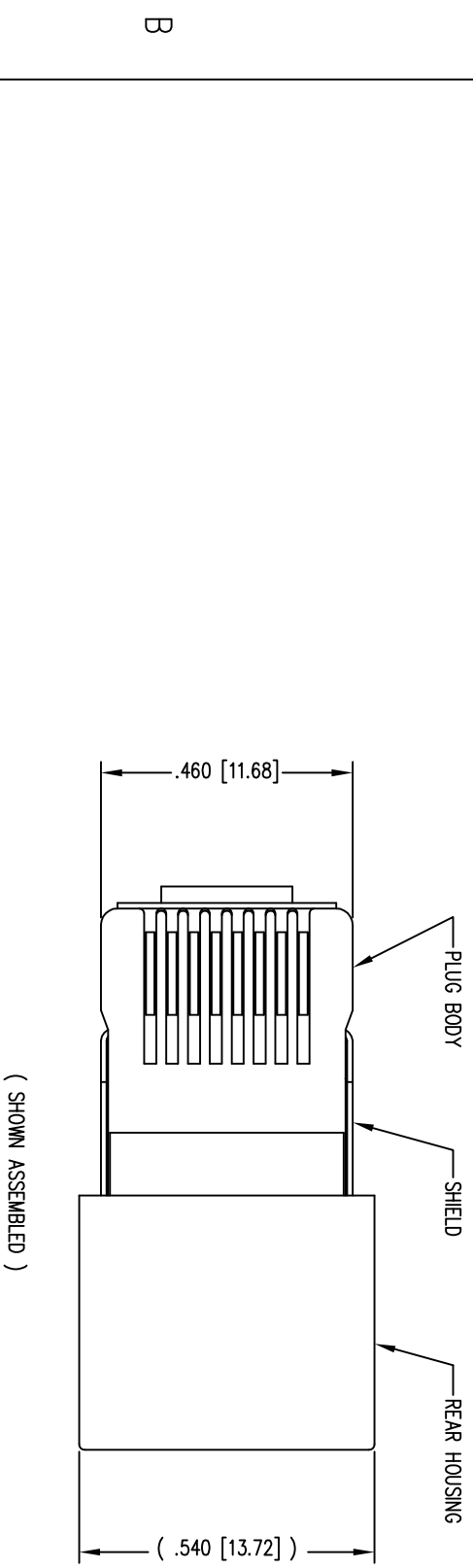

B

B

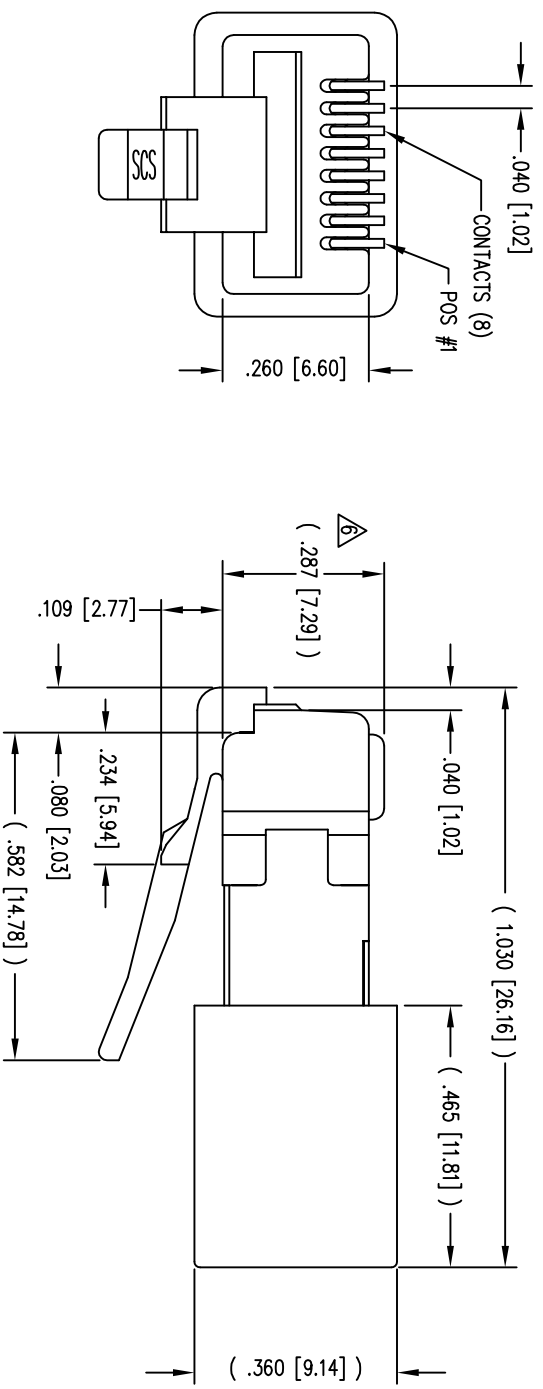

A

A

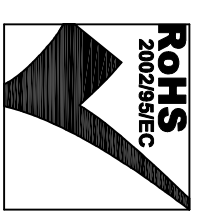
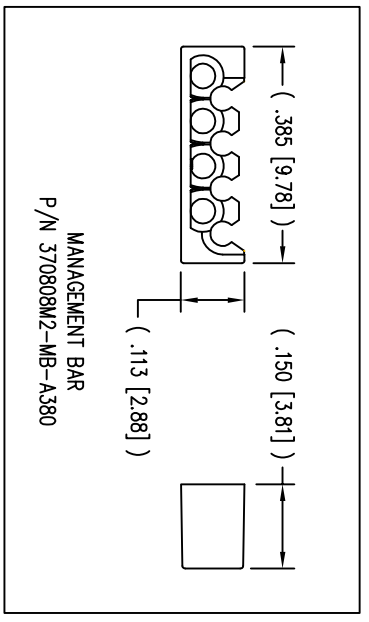
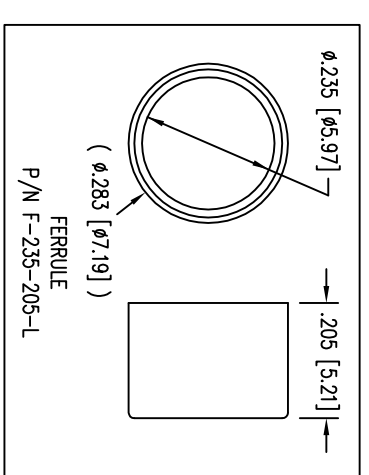
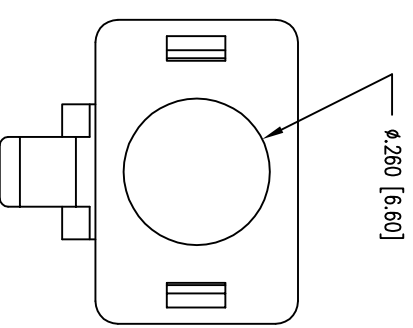

BULK	50 MICRO-INCHES [1.27um]	943-SP-370808SM2-A380
PACKAGE	CONTACT PLATING IN MATING AREA	PART NUMBER

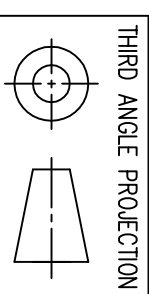

Bel Stewart Connector
 11118 Susquehanna Trail South
 Glen Rock, PA 17327-9199
 (717) 235-7512 Fax: (717) 235-7954
<http://www.stewartconnector.com>

DO NOT SCALE DRAWING DRAWING IS SUBJECT TO CHANGE WITHOUT NOTICE	TITLE: SHIELDED CAT 5 PLUG 8 X 8	DRN BY: JAF	DATE: 10-7-97
DIMENSIONS: INCHES [METRIC]		APP'D BY: RL	DATE: 10-7-97
UNLESS OTHERWISE SPECIFIED TOLERANCES ARE ±.005 [0.13] ANGLES ARE ± 1°		DWG NO: CT370015	REV: B4
SHEET NO: 1 OF 1			