

### Top View of Assembly

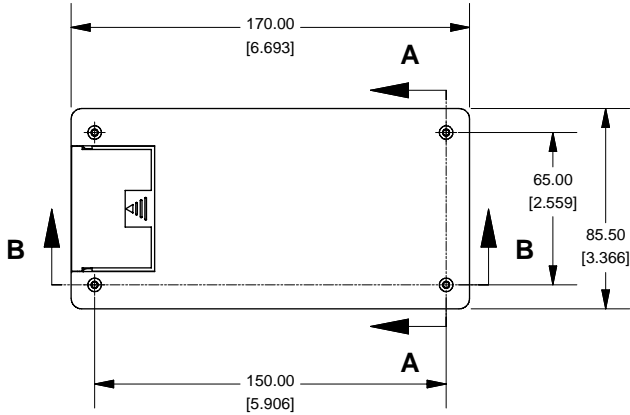

### SECTION A-A End View of Assembly

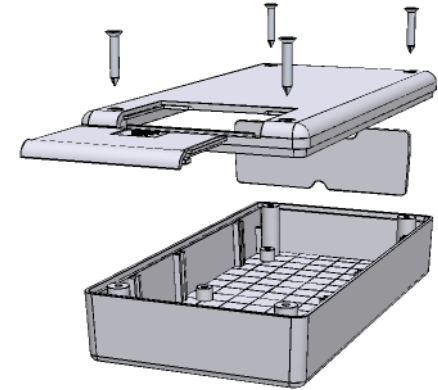
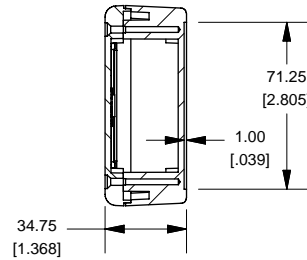

### SECTION B-B Side View of Assembly

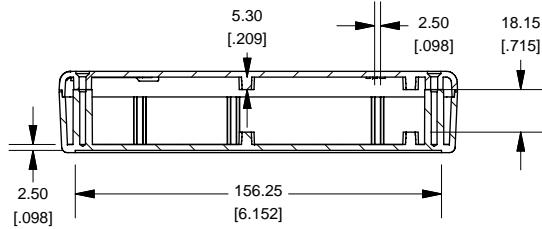

### Top View Looking Inside Box

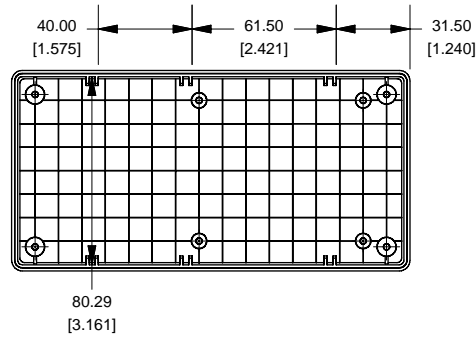

### Lid

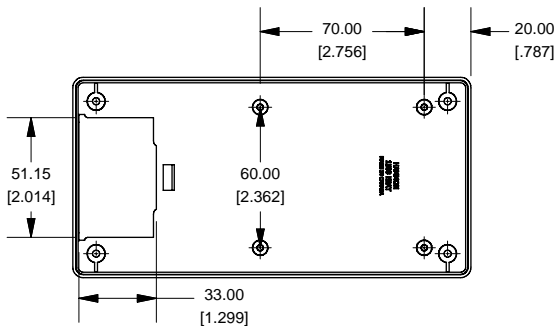

### Divider

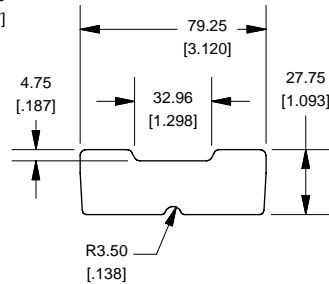

### Maximum P.C. Board Size

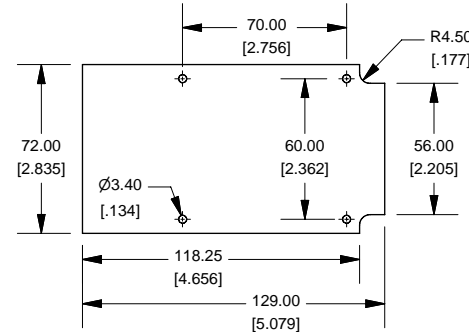

Enclosures can be Factory Modified ( Milling, Drilling, Printing etc. )  
 Contact Factory [mjm@hammondmfg.com](mailto:mjm@hammondmfg.com) for quotes  
 Solid models of this enclosure available in STEP or IGES.

NOTE	
Purchased assembly includes box, lid and 4 cover screws. Flame retardant ABS carries UL flammability rating of 94 V-0. Various Battery holder kits available.	
PART NUMBERS	
1599E Fire Retardant ABS	
Black FR-ABS	1599EBKBAT
Grey FR-ABS	1599EGYBAT
1599E High Impact Polystyrene	
Black GP-ABS	1599ESBKBAT
Grey GP-ABS	1599ESGYBAT
ACCESSORIES	
Cover Screws for FR-ABS (Pkg 100)	1591MS100
[M3 - 0.5 x 20mm Nickel Plated Machine Screws]	
Cover Screws for GP-ABS (Pkg 100)	1598TS100
[#4 x 3/4" Stainless Steel Self Tapping Screws]	
P.C Board Mounting Screws (Pkg of 50 or 100)	1593ATS50
[#4 x 1/4" Self Tapping Screws]	1593ATS100

