

ACT8945AEVK1-305 User's Guide

Description

This document describes the characteristic and operation of the Active Semi ACT8945AEVK1-305 evaluation kit (EVK). It provides setup and operation instructions, schematic, layout, BOM, and test data. This EVK demonstrates the ACT8945AQJ305 ActivePMU power management IC. Other ACT8945AQJxxx options can be evaluated on this EVK by replacing the IC and any other necessary components.

Features

The EVK can be used as a standalone board if desired. However, to access the internal registers and to take full advantage of the IC's capability, the user must connect the EVK kit to a PC with Active Semi's USB-TO-I2C interface dongle and use the GUI software. The EVK provides full access to the each converter's input and output voltage, as well as all the digital control signals. This gives the user the flexibility to configure the EVK to match their real world system.

Note that the ACT8945AEVK1-305 is specifically configured for the ACT8945AQJ305.



Figure 1 – EVK Picture

Setup

Required Equipment

ACT8945A EVK1-305

USB-TO-I2C Dongle

Power supply – 5V @ 3A for full power operation

Oscilloscope – >100MHz, 4 channels

Loads – Electronic or resistive. 2A minimum current capability.

Digital Multimeters (DMM)

Windows compatible computer with spare USB port.

EVK Setup

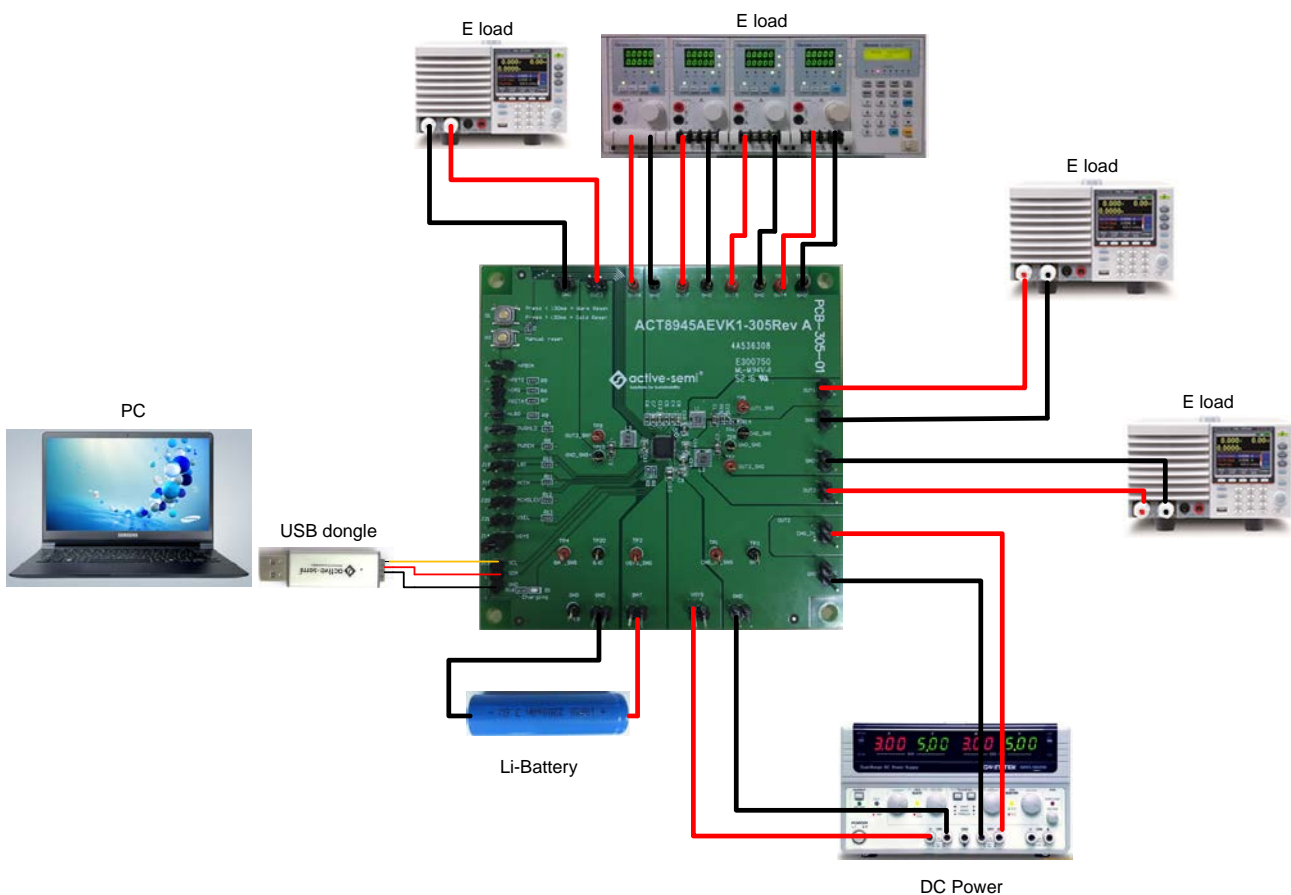

Figure 2 – EVK Setup

Hardware Setup

1. Connect a lab supply between VSYS (J3) and GND (J4) to power all the regulators and LDOs.
2. Connect a lab supply between CHG_IN (J1) and GND (J2) to power the charger.
3. Connect a Li-Battery between BAT (J5) and GND (J6).
4. Connect an appropriate load to each power supply output.
5. Note that the typical setup is to apply the same 5V input voltage to all inputs.

GUI Setup (optional)

1. Refer to the end of this document for detailed instructions to install the ACT8945A GUI.
2. Connect the USB-TO-I2C dongle to the computer via a USB cable.
3. Connect the USB-TO-I2C dongle to the EVK J13 connector. Refer to Figure 3 to ensure the correct polarity of the connection. As a guide, use the “Active-Semi” logo on the top of the dongle so the black wire is connected toward the lower left corner of the Dongle.

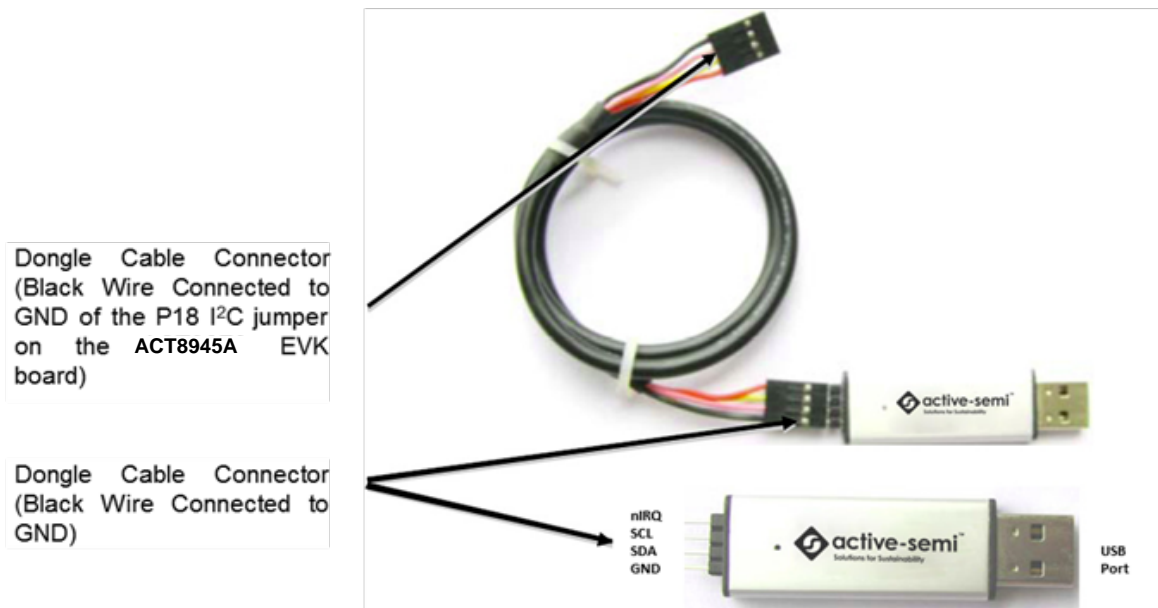

Figure 3 – USB-TO-I2C Dongle Connection

Recommended Operating Conditions

The ACT8945AEVK1-305 is designed for a 5V input voltage. The maximum operating voltage is determined by the IC's maximum input voltage rating. The minimum operating voltages are determined by the buck converters' minimum input voltage and by the LDOs' dropout voltages. Maximum currents are determined by the IC's CMI settings, which can be changed via I2C after startup.

Table 1. Recommended Operating Conditions

Parameter	Description	Min	Typ	Max	Unit
VSYS	All buck and LDO input voltages	2.7	5	5.5	V
CHG_IN	Charger input voltage	4.35	5	6	V
BAT	Charger output voltage		4.2	4.35	V
I _{out1_max}	Maximum Buck REG1 load current		1.15		A
I _{out2_max}	Maximum Buck REG2 load current		1.15		A
I _{out3_max}	Maximum Buck REG3 load current		1.3		A
I _{out4_max}	Maximum LDO REG4 load current		0.32		A
I _{out5_max}	Maximum LDO REG5 load current		0.32		A
I _{out6_max}	Maximum LDO REG6 load current		OFF		A
I _{out7_max}	Maximum LDO REG7 load current		OFF		A

EVK Operation

Turn On the Evaluation board

Before applying the input voltage, please make sure the jumper (J14) is installed.

When the power source and load are connected to the evaluation board, it can be powered for operation. Perform the following steps to turn on the board.

1. Ensure that the power source voltage is >4.2V and <6V.
2. Ensure that nPBIN is not always low and monitor the output voltage from OUT1 to OUT7.
3. Turn on the load, check that it is drawing the proper load current, and verify that the output voltage maintains its regulation.

Changing Charge Configuration

The ACT8945A's *ActivePath* charger features a flexible charge current-programming scheme that combines the convenience of internal charge current programming with the flexibility of resistor based charge current programming. Current limits and charge current programming are managed as a function of the ACIN (J19) and CHGLEV (J20) pins, in combination with R_{IS}ET, which is connected to ISET pin. Users configure the charge current by pulling J19 and J20 high/low with jumpers per the table below.

ACIN J19	CHGLEV J20	CHARGE CURRENT (mA)	PRECONDITION CHARGE CURRENT (mA)
ON	ON	90	45
ON	OFF	450	45
OFF	ON	ICHG/5	10% \times ICHG
OFF	OFF	ICHG	10% \times ICHG

Measuring Output Voltage Ripple

To observe the output voltage ripple, place the oscilloscope probe across the output capacitor with the probe ground lead connected to the negative (-) capacitor terminal and the probe tip placed at the positive (+) capacitor terminal. Set the oscilloscope to ac, 5mV/division, 1us/division time base, and 20MHz bandwidth.

A standard oscilloscope probe has a long wire ground clip. For high frequency measurements, this ground clip picks up high frequency noise and injects it into the measured output ripple. Figure 4 shows an easy way to measure the output ripple properly. It requires removing the oscilloscope probe sheath and wrapping an unshielded wire around the oscilloscope probe as short as possible, the true ripple can be measured.

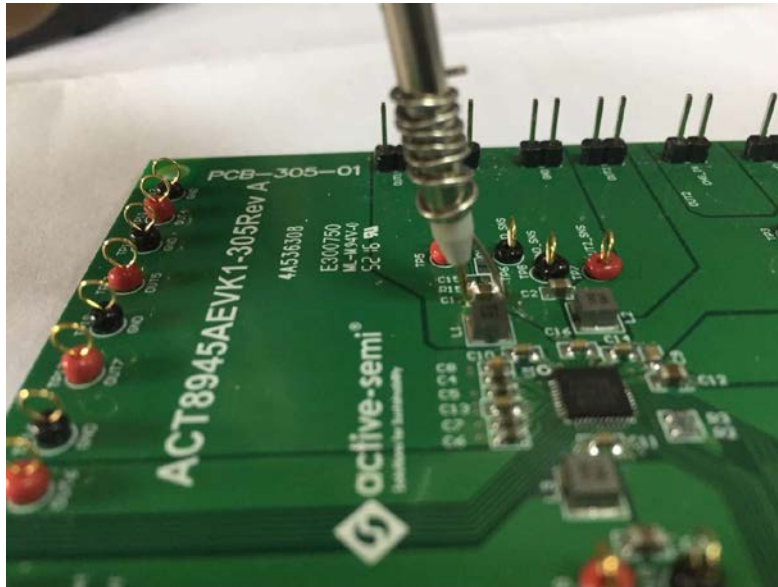

Figure 4 – Measuring output voltage ripple

Test Load Transient Response

To test the load transient response, generate a load current transient at the output and observe the output voltage response using an oscilloscope. Attach the current probe to the wire between the output and the load to capture the current transient waveform. The method of testing the output voltage load transient response is the same as that of testing output voltage ripple.

Measuring Efficiency

The Efficiency is measured by comparing the input power with the output power. Measure the input and output voltage as close as possible to the input and output capacitor to reduce the effect of voltage drops in the PCB and connectors.

Test Results

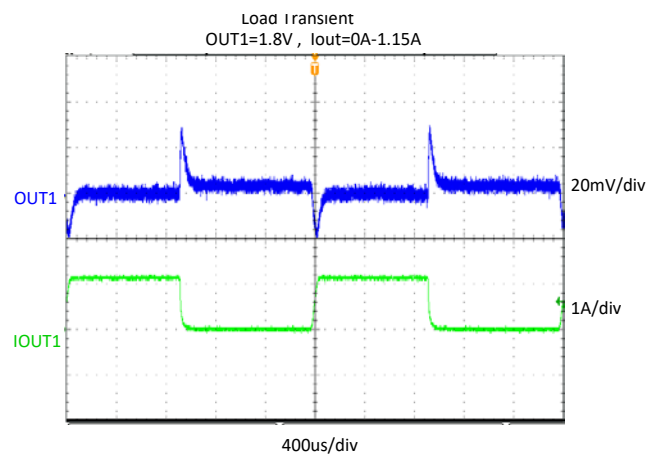
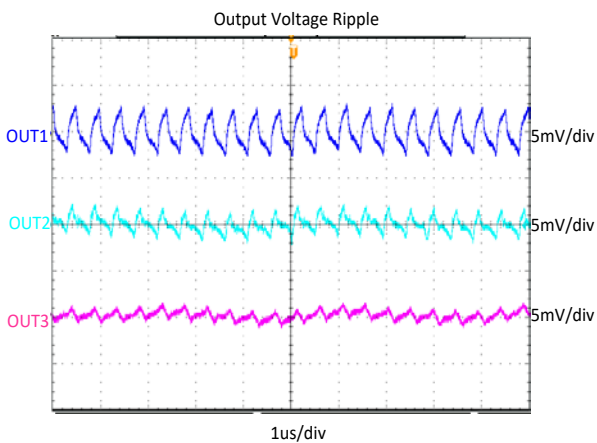
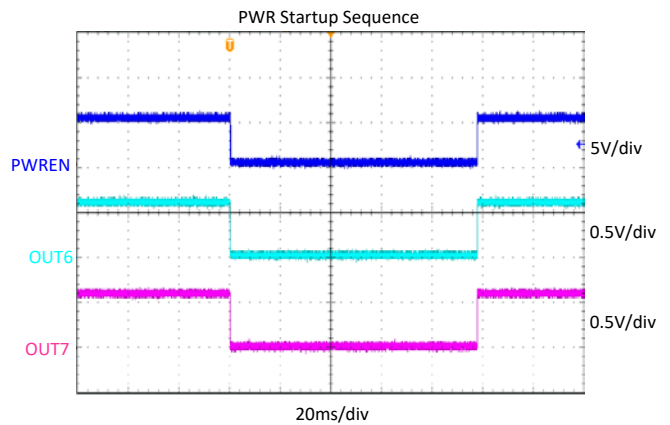
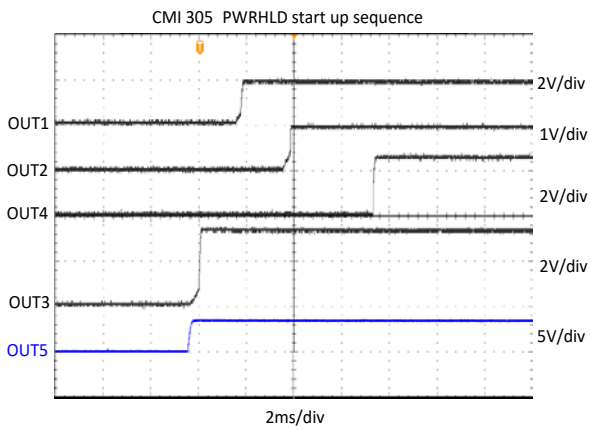
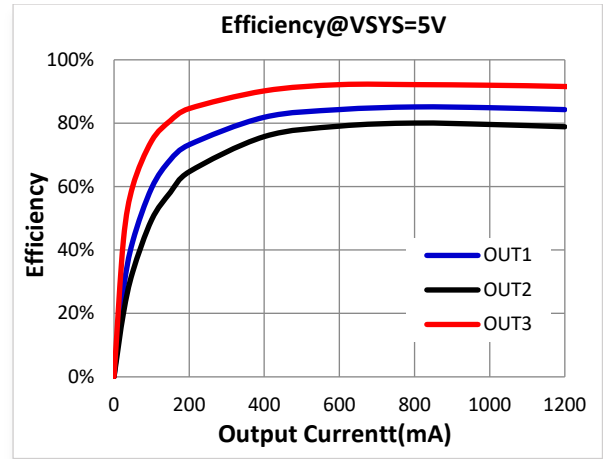
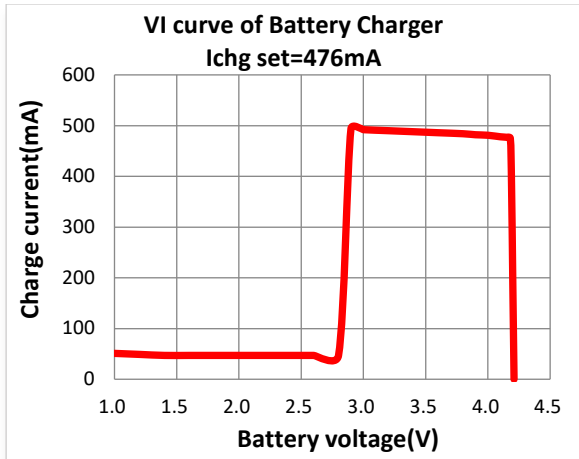

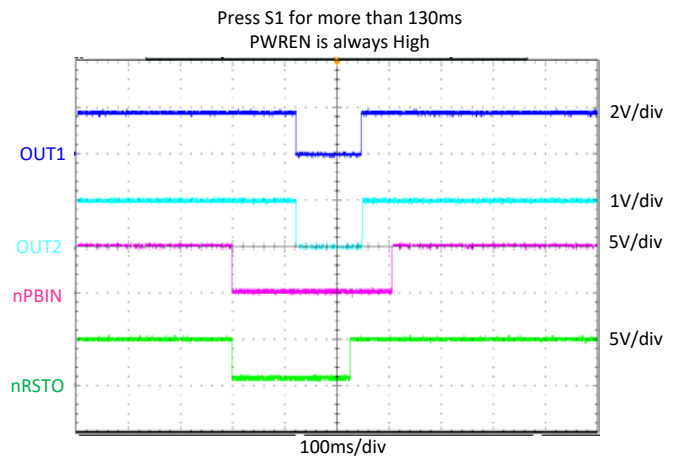
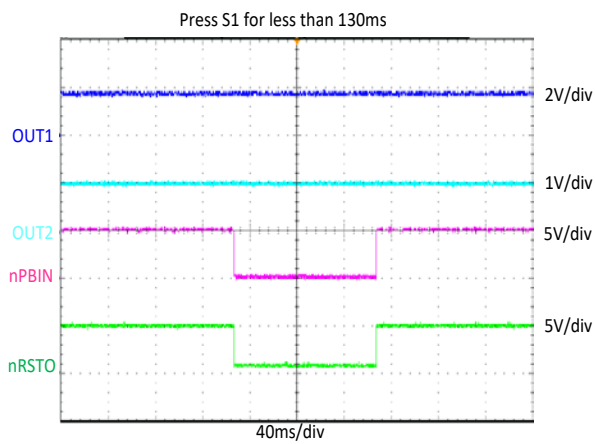
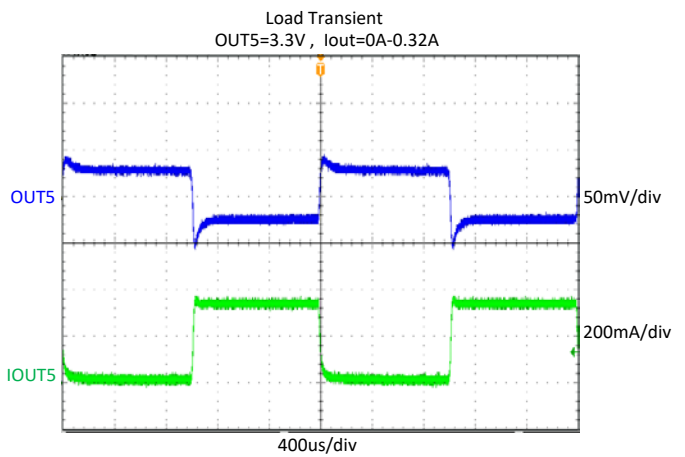
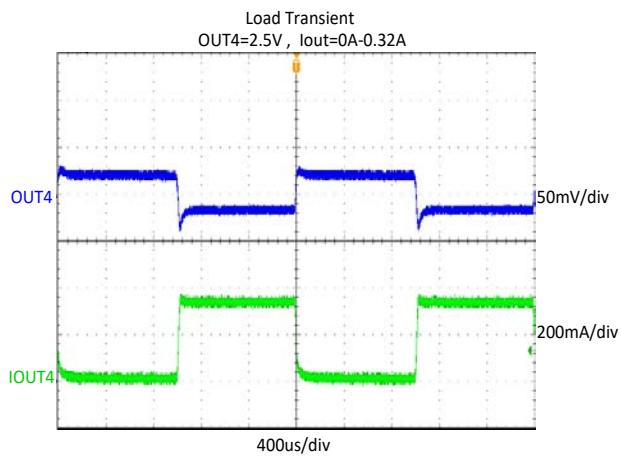
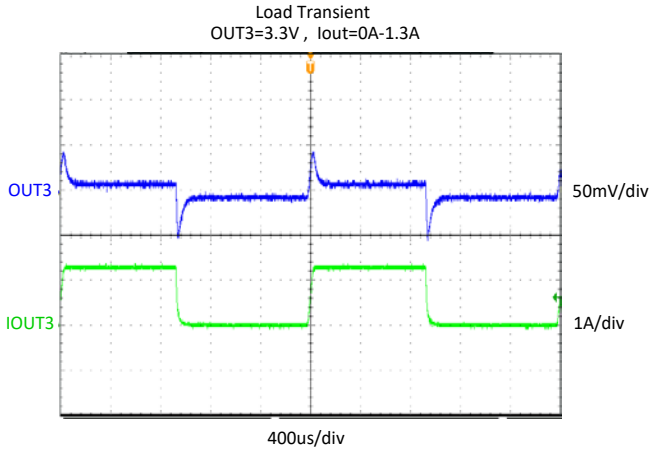
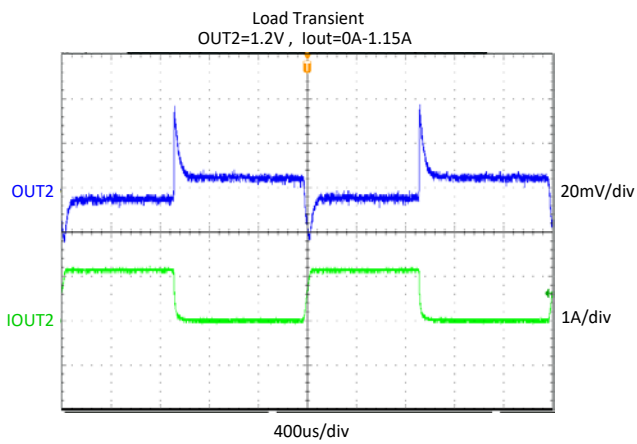

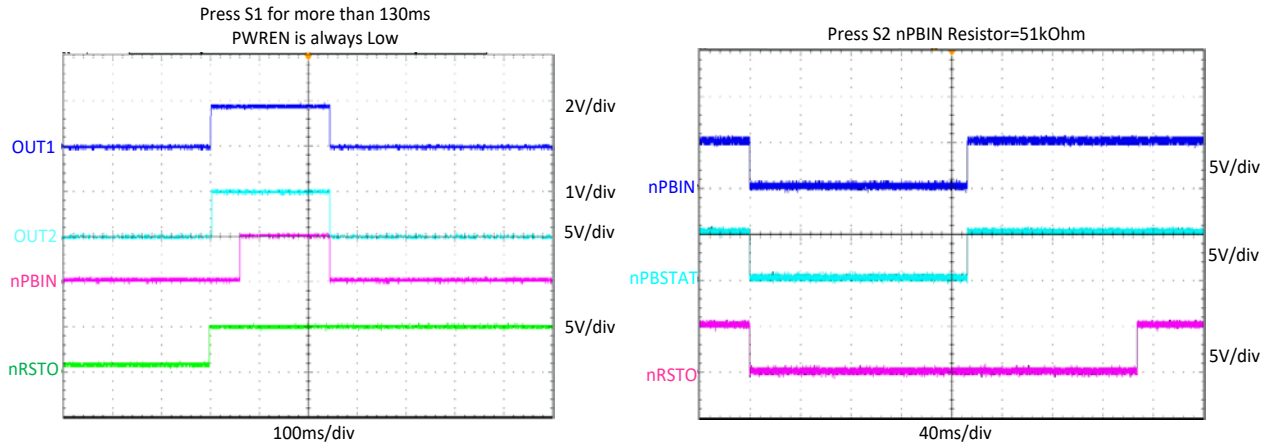

Schematic

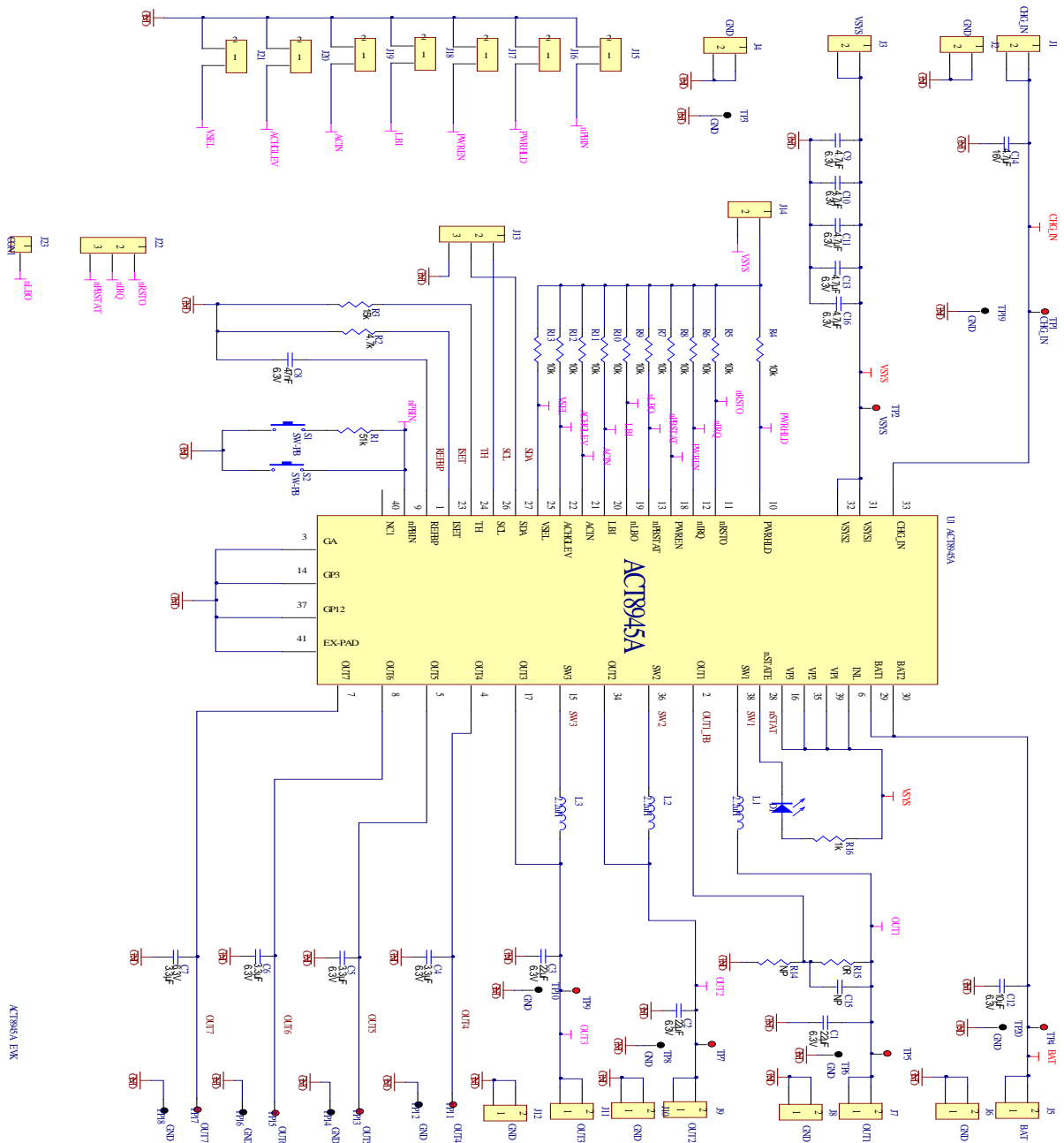

Layout

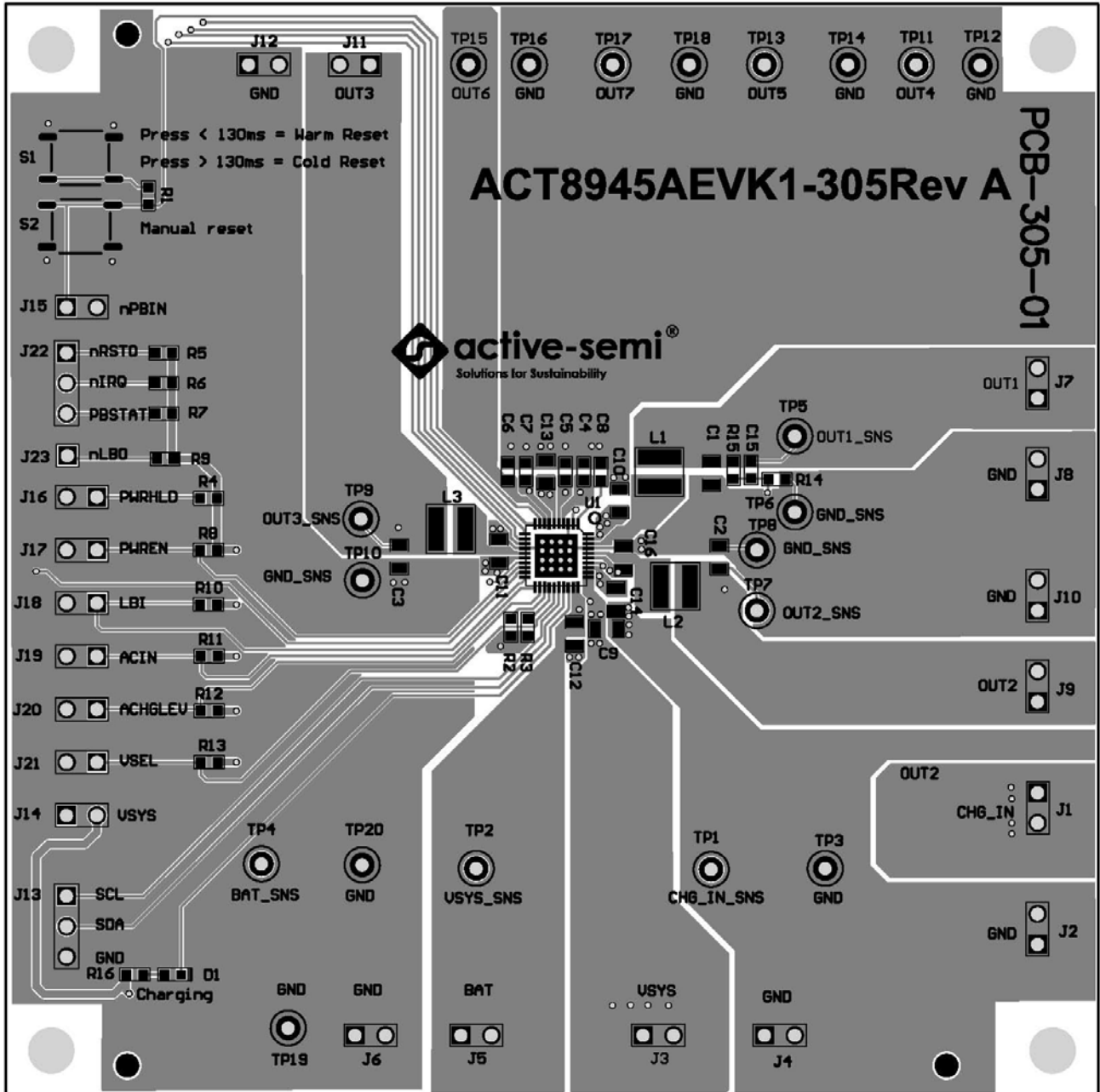

Figure 5 – Layout Top Layer

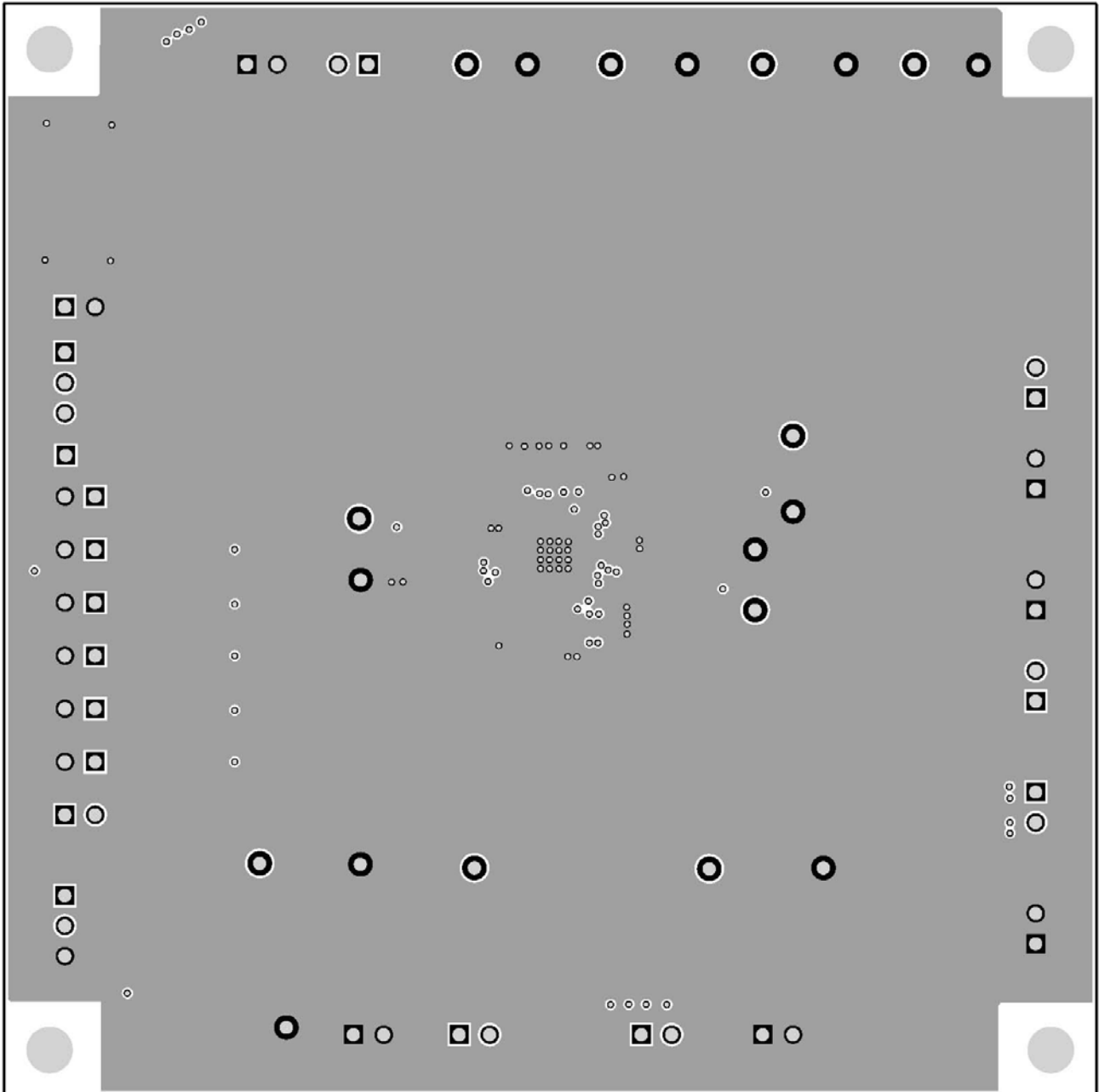

Figure 6 – Layout Layer GND

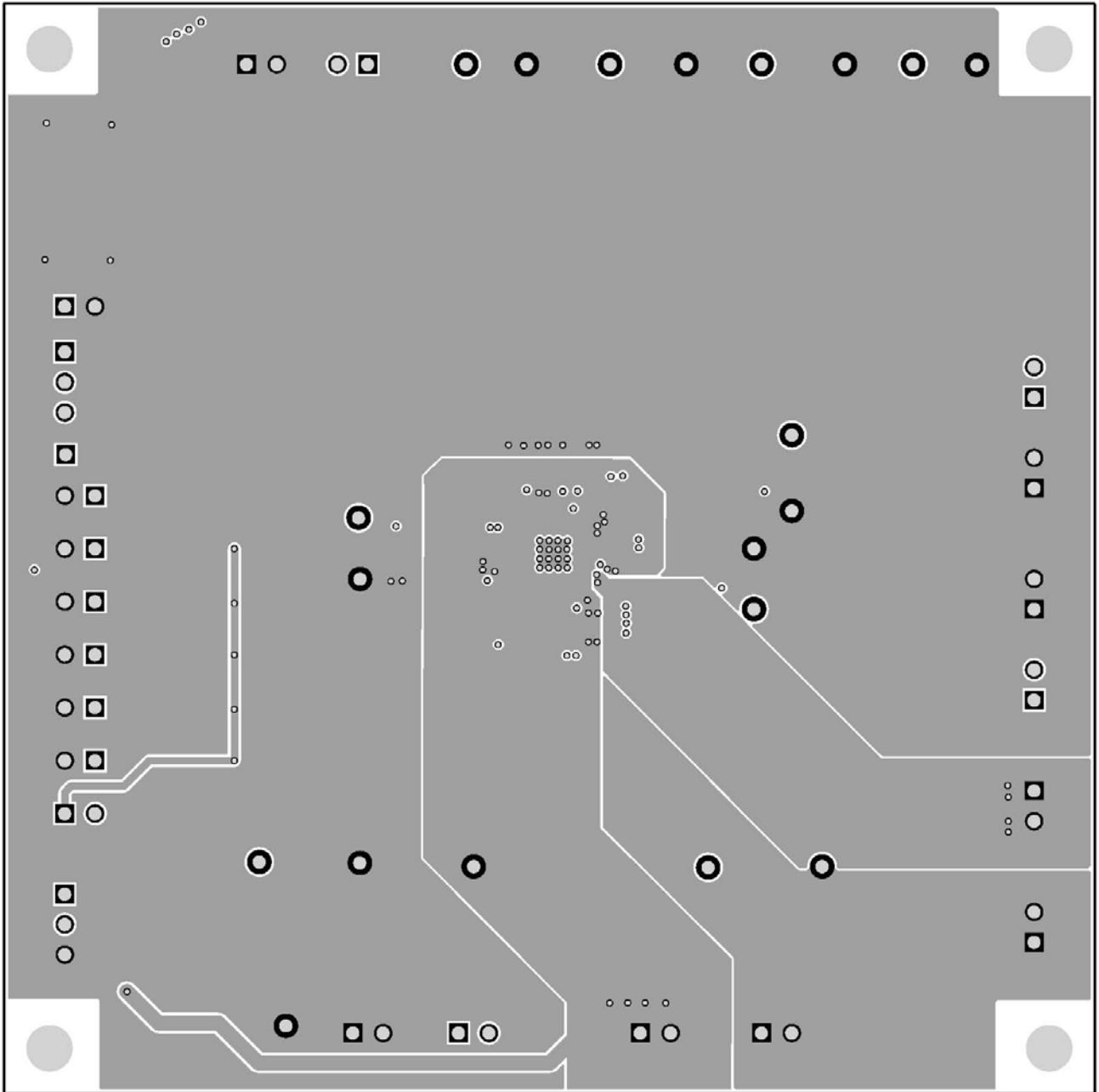

Figure 7 – Layout Layer VCC

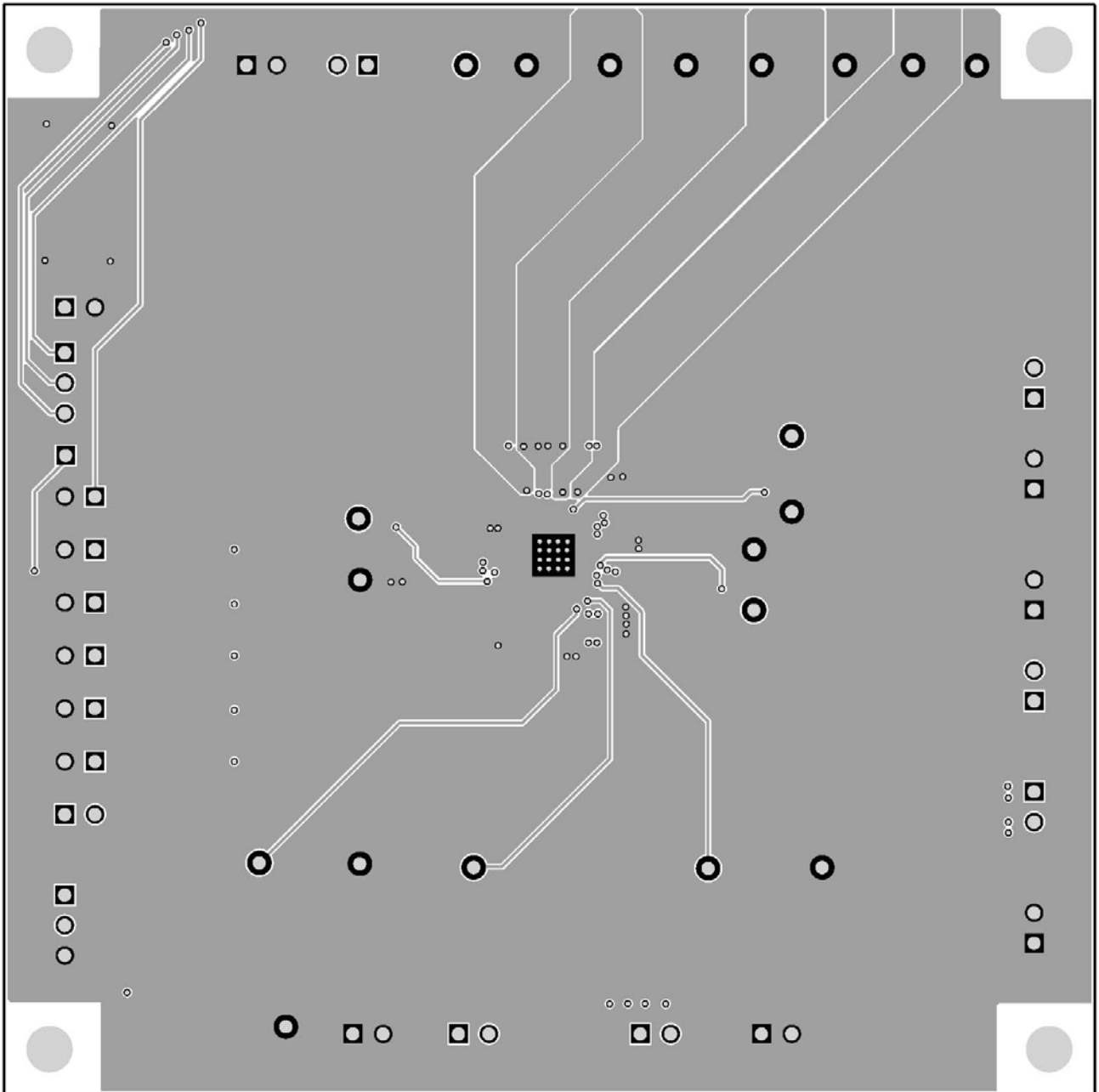

Figure 8 – Layout Bottom Layer

Bill of Materials

Table 2. BOM list of EVK board

Item	Ref Des	QTY	Description	Package	MFR	Part Number
1	C1,C2,C3	3	Cap, Ceramic, 22uF, 6.3V, 10%, X7R	0805	std	std
2	C4,C5,C6,C7	4	Cap, Ceramic, 3.3uF, 6.3V, 10%, X7R	0603	std	std
3	C8	1	Cap, Ceramic, 47nF, 6.3V, 10%, X7R	0603	std	std
4	C9,C10,C11,C13,C16	2	Cap, Ceramic, 4.7uF, 6.3V, 10%, X7R	0805	std	std
5	C12	1	Cap, Ceramic, 10uF, 6.3V, 10%, X7R	0805	std	std
6	C14	1	Cap, Ceramic, 4.7uF, 16V, 10%, X7R	0805	std	std
7	C15	0	NP	0805	std	std
8	R1	1	Res, 51kΩ, 1%	0603	std	std
9	R2	1	Res, 4.7kΩ, 1%	0603	std	std
10	R3	1	Res, 15kΩ, 1%	0603	std	std
11	R4,R5,R6,R7,R8,R9,R10,R11,R12,R13	10	Res, 10kΩ, 1%	0603	std	std
12	R14	0	NP	0603	std	std
13	R15	1	Res, 0Ω, 1%	0603	std	std
14	R16	1	Res, 1kΩ, 1%	0603	std	std
15	U1	1	ACT8945AQJ305-T	5x5mm TQFN55-40	std	std
16	D1	1	LED, Bright Green	0603	Würth Elektronik	150060VS75000
17	L1,L2,L3	3	Würth inductor 1.5uH	4mmx4mm mx3.8mm	Würth Elektronik	74438336015
18	S1,S2	2	SMT Tact switch 4mmx4mmx1.5mm	4x4x1.5	C&K	PTS525SK15SM TR2LFS
19	J1,J2,J3,J4,J5,J6,J7,J8,J9,J10,J11,J12,J14,J15,J16,J17,J18,J19,J20,J21	20	Header, 2 pin, 100mil		Würth Elektronik	61300211119
20	J13	1	Header, 3 pin, 100mil		Würth Elektronik	61300211120
21	J22	1	Header, 4 pin, 100mil		Würth Elektronik	61300211120
22	J23	1	Header, 1 pin, 100mil		Würth Elektronik	61300211120
23	TP1,TP2,TP4,TP5,TP7,TP9,TP11,TP13,TP15,TP17,	10	Test Point, Red, Through Hole, 1mm	0.040"	Keystone	5000
24	TP3,TP6,TP8,TP10,TP12,TP14,TP16,TP18,TP19,TP20	10	Test Point, Black, Through Hole, 1mm	0.040"	Keystone	5000
25	--	1	PCB, ACT8945AEVK1-305	n/a	n/a	PCB-305-01
26	--	7	Shunt, 100mil, Black	n/a	n/a	60900213421

GUI Installation

1. Contact Active Semi for the GUI files and save them on your computer.
2. Plug the USB-TO-I2C dongle into a free USB port.
3. Follow the instructions in the “How to install driver for dongle” folder.
4. Double click on the ACT8945A GUI.exe to start the ACT8945A GUI.

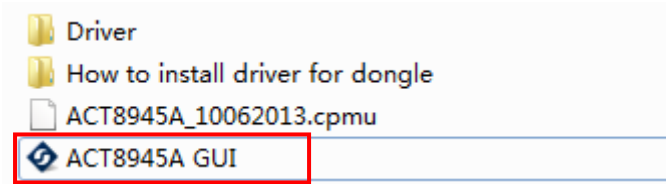

GUI Overview

The GUI has 2 basic function buttons allocated in top-left of the Tool Bar which are Read and Write I2C. The GUI contains 2 setting modes: Basic Mode and Advanced Mode. In Basic Mode screen it displays basic user programmable configuration options are programmed using the drop-down boxes or check boxes. Advanced Mode contain the button text for changing setting for every single bit.

Basic Mode

The following figure show the GUI in basic mode. This mode allows the user to easily change one or more IC settings.

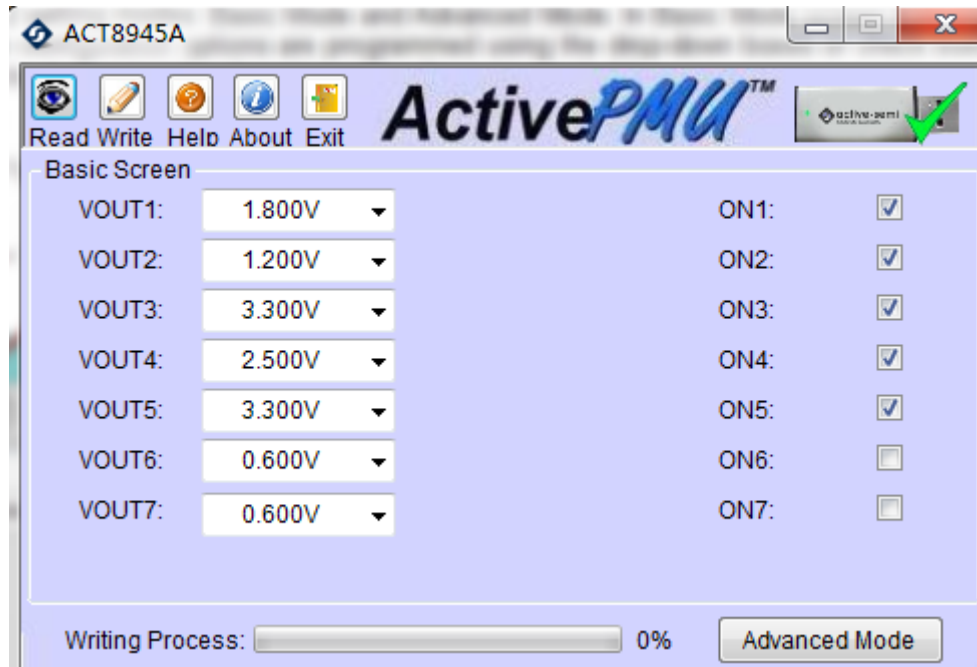

Advanced Mode

Click the “Advanced Mode” button in the left of the GUI screen to see all available user programmable options. With Advanced Mode, additional user programmable features can be selected using the button text. In the left side of the Advanced Mode Screen, click on the Tiles Selector to display the register to view or change. Then change a register one bit at a time by clicking on the desired bit. The value of the bit is display right next to the bit-name button.

Note that the far right side of the screen contains a scroll down button to scroll down to additional registers since the Tile Screen can only display up to 8 bytes at once.

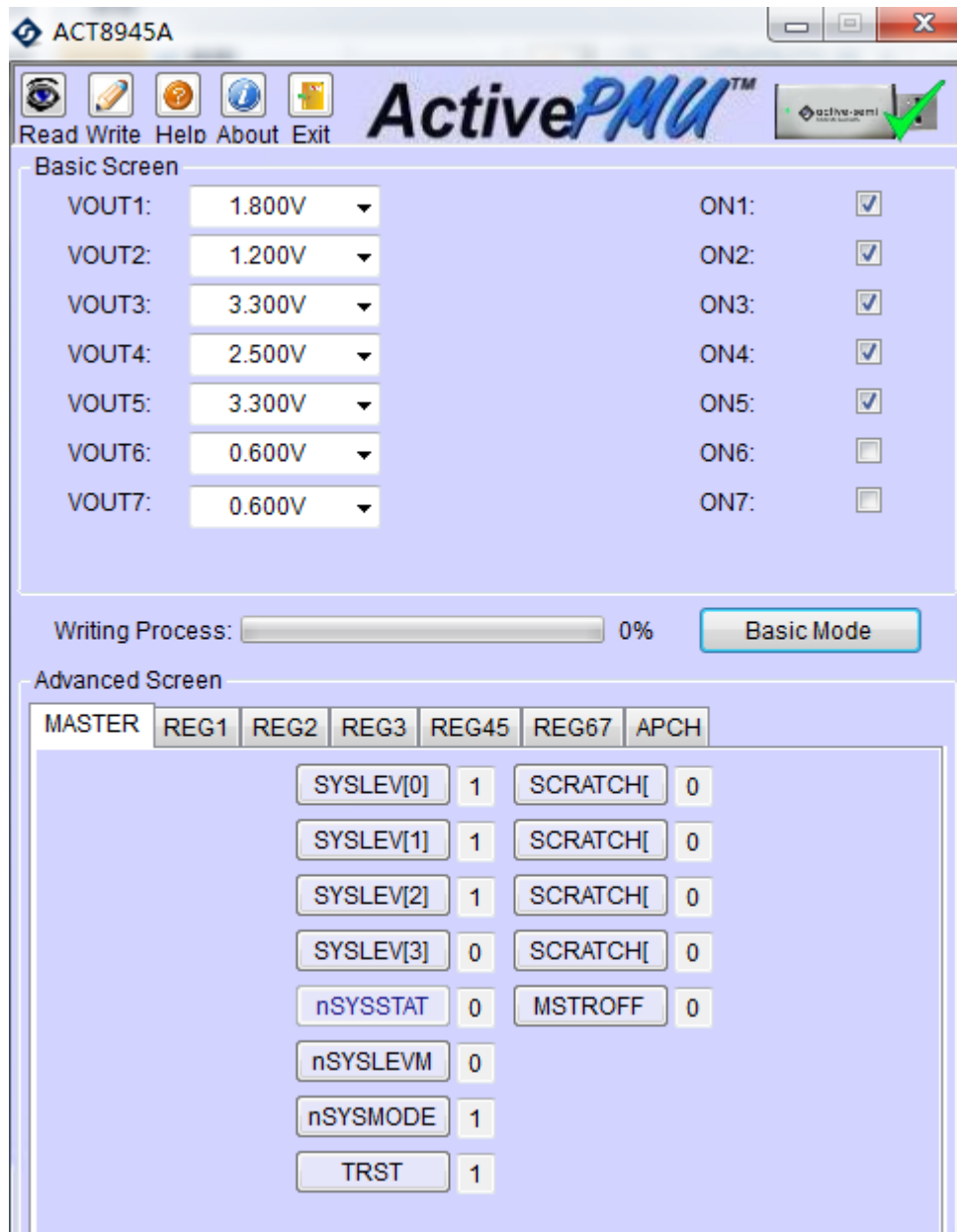

Button Descriptions

Read: Clicking on this button reads the ACT8945A registers and displays them in the GUI. Note that this reads all registers. Active-Semi recommends reading registers each time the ACT8945A powers-up to acquire the initial register settings. Active-semi also recommends reading registers after making changes to them. Immediately reading the registers after a write confirms the changes were properly stored.

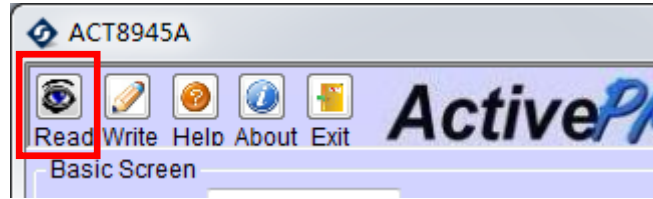

Read Button

Write: Clicking on this button writes the GUI settings to the ACT8870's registers. All registers are written, regardless of whether or not they were changed.



Write Button

Dongle Connection Status: The GUI also contains a dongle is connected status which indicates that Active-Semi's USB-TO-I2C dongle is connected to the USB port of the driver installed. The figure below shows the two possible indication status graphics.

Dongle connected



Dongle Disconnected

