

SACCEC-M12MSB-2CON-M16/1,0-910

Order No.: 1525568

<http://eshop.phoenixcontact.de/phoenix/treeViewClick.do?UID=1525568>

Bus system flush-type plug, PROFIBUS, 2-pos., M12, shielded, B-coded, front/screw mounting with M16 thread, with 1 m bus cable, 2 x 0.25 mm²



Commercial data	
GTIN (EAN)	 4 046356 022309
sales group	D125
Pack	1 pcs.
Customs tariff	85444290
Catalog page information	Page 273 (PC-2009)

Product notes

WEEE/RoHS-compliant since:
03/09/2006



<http://www.download.phoenixcontact.com>
Please note that the data given here has been taken from the online catalog. For comprehensive information and data, please refer to the user documentation. The General Terms and Conditions of Use apply to Internet downloads.

Technical data

General data

Rated current at 40°C	4 A
Rated voltage	60 V
Number of positions	2
Volume resistance	≤ 3 mΩ

Insulation resistance	≥ 100 MΩ
Length of cable	1 m

General characteristics

Coding	B - inverse
Surge voltage category	II
Pollution degree	3
Degree of protection	IP67
Contact material	CuZn
Contact surface material	Ni/Au
Contact carrier material	PA 66
Material, knurls	Nickel-plated brass
Sealing material	NBR
Mounting type	Front mounting M16 x 1.5 With locking nut
Type of connection	PROFIBUS
Status display	No
Test voltage	2500 V

Conductor data

Cable type	PROFIBUS
Cable type (abbreviation)	910
Conductor cross section	0.25 mm ²
AWG signal line	24
Conductor structure signal line	19x 0.13 mm
Core diameter including insulation	2.55 mm ±0.07 mm
External cable diameter	7.80 mm
Wire colors	Red, green
External sheath, color	Violet, RAL 4001
Insulation resistance	≥ 5 GΩ*km
Conductor resistance	≤ 78.4 Ω/km
Working capacitance	32 pF (core-core)
Wave impedance	Nom. 150 Ω ±10 %
Nominal voltage, conductor	30 V
Test voltage Core/Core	1500 V
Type of pair shielding	Aluminum-lined polyester foil
Overall twist	2 cores with 2 fillers to the core

Shielding	Tinned copper braided shield
Optical shield covering	80 %
Outer sheath, material	PUR
Material conductor insulation	Foamed PE
Conductor material	Tin-plated Cu litz wires
Smallest bending radius, fixed installation	min. 78 mm
Smallest bending radius, movable installation	min. 78 mm
Number of bending cycles	5000000
Bending radius	78 mm
Traversing path	10 m
Traversing rate	3 m/s
Acceleration	7 m/s ²
Ambient temperature (operation)	-20 °C ... 80 °C (cable, fixed installation)
	-20 °C ... 80 °C (cable, flexible installation)
Flame resistance	IEC 60332-1
	DIN EN 50265-2-1

Diagrams/Drawings

Dimensioned drawing

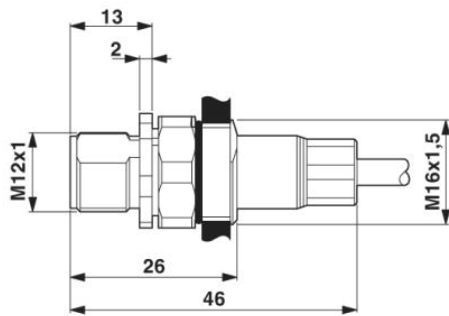

M12 flush-type connector

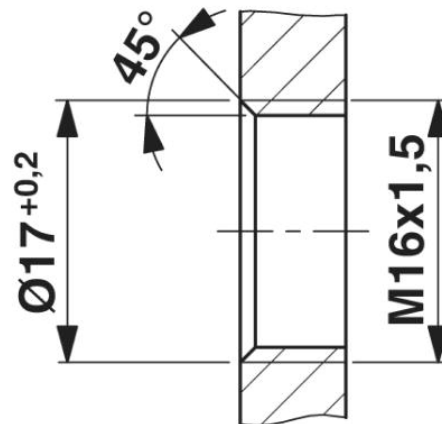

Housing cutout for M16 fastening thread,
mounting panel with thread

Circuit diagram

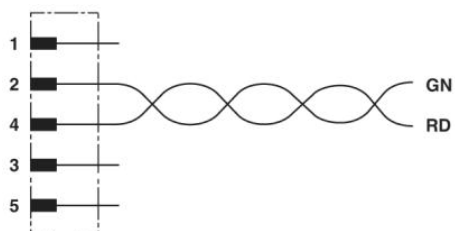

Contact assignment of the M12 plug

Schematic diagram

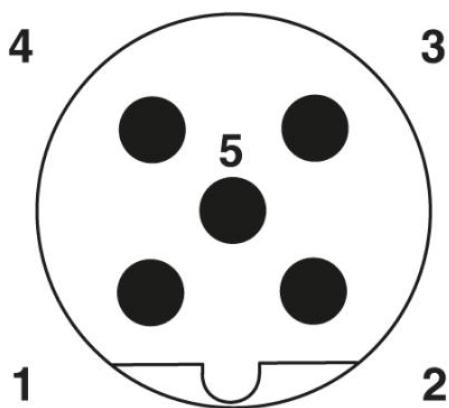

Pin assignment M12 male connector, 5-pos., B-coded, male side

Address

PHOENIX CONTACT Inc., USA
586 Fulling Mill Road
Middletown, PA 17057, USA
Phone (800) 888-7388
Fax (717) 944-1625
<http://www.phoenixcon.com>



© 2010 Phoenix Contact
Technical modifications reserved;