



CY8CKIT-006 PSoC[®] 3 LCD Segment Drive Evaluation Kit Guide

Doc. # 001-52798 Rev. *C

Cypress Semiconductor
198 Champion Court
San Jose, CA 95134-1709
Phone (USA): 800.858.1810
Phone (Intl): 408.943.2600
<http://www.cypress.com>

Copyrights

© Cypress Semiconductor Corporation, 2009-2010. The information contained herein is subject to change without notice. Cypress Semiconductor Corporation assumes no responsibility for the use of any circuitry other than circuitry embodied in a Cypress product. Nor does it convey or imply any license under patent or other rights. Cypress products are not warranted nor intended to be used for medical, life support, life saving, critical control or safety applications, unless pursuant to an express written agreement with Cypress. Furthermore, Cypress does not authorize its products for use as critical components in life-support systems where a malfunction or failure may reasonably be expected to result in significant injury to the user. The inclusion of Cypress products in life-support systems application implies that the manufacturer assumes all risk of such use and in doing so indemnifies Cypress against all charges.

Any Source Code (software and/or firmware) is owned by Cypress Semiconductor Corporation (Cypress) and is protected by and subject to worldwide patent protection (United States and foreign), United States copyright laws and international treaty provisions. Cypress hereby grants to licensee a personal, non-exclusive, non-transferable license to copy, use, modify, create derivative works of, and compile the Cypress Source Code and derivative works for the sole purpose of creating custom software and or firmware in support of licensee product to be used only in conjunction with a Cypress integrated circuit as specified in the applicable agreement. Any reproduction, modification, translation, compilation, or representation of this Source Code except as specified above is prohibited without the express written permission of Cypress.

Disclaimer: CYPRESS MAKES NO WARRANTY OF ANY KIND, EXPRESS OR IMPLIED, WITH REGARD TO THIS MATERIAL, INCLUDING, BUT NOT LIMITED TO, THE IMPLIED WARRANTIES OF MERCHANTABILITY AND FITNESS FOR A PARTICULAR PURPOSE. Cypress reserves the right to make changes without further notice to the materials described herein. Cypress does not assume any liability arising out of the application or use of any product or circuit described herein. Cypress does not authorize its products for use as critical components in life-support systems where a malfunction or failure may reasonably be expected to result in significant injury to the user. The inclusion of Cypress' product in a life-support systems application implies that the manufacturer assumes all risk of such use and in doing so indemnifies Cypress against all charges.

Use may be limited by and subject to the applicable Cypress software license agreement.

PSoC[®] Creator[™] is a trademark and PSoC[®] is a registered trademark of Cypress Semiconductor Corp. All other trademarks or registered trademarks referenced herein are property of the respective corporations.

Flash Code Protection

Cypress products meet the specifications contained in their particular Cypress PSoC Data Sheets. Cypress believes that its family of PSoC products is one of the most secure families of its kind on the market today, regardless of how they are used. There may be methods, unknown to Cypress, that can breach the code protection features. Any of these methods, to our knowledge, would be dishonest and possibly illegal. Neither Cypress nor any other semiconductor manufacturer can guarantee the security of their code. Code protection does not mean that we are guaranteeing the product as "unbreakable."

Cypress is willing to work with the customer who is concerned about the integrity of their code. Code protection is constantly evolving. We at Cypress are committed to continuously improving the code protection features of our products.

Contents



1. Introduction	5
1.1 Kit Contents	5
1.2 PSoC Creator	6
1.3 Getting Started	6
1.4 Additional Learning Resources.....	6
1.5 Document History	6
1.6 Document Conventions	6
2. Installation	7
2.1 CD Installation	7
2.2 Hardware	7
2.3 Software	8
3. Kit Operation	9
3.1 Introduction.....	9
3.2 Main Menu	10
3.3 PUNCH.....	10
3.3.1 1:GAUGE.....	10
3.3.2 1:HIGH.....	11
3.3.3 1:RECALL.....	11
3.3.4 1:CLEAR.....	11
3.4 RTC/TEMP	12
3.4.1 2:Clock.....	12
3.4.2 2:SetTim	12
3.4.3 2:SetDat.....	13
3.4.4 2:SetAlm	13
3.4.5 2:Alarm	14
3.5 CONTRAST.....	14
3.6 LCD DEMO.....	15
3.7 Restore Default Firmware.....	15
3.8 Example Projects.....	17
4. Hardware	19
4.1 System Block Diagram	19
4.2 Operation Theory - All Components	20
4.3 Functional Description	21
4.3.1 LCD Glass	21
4.3.1.1 Glass Specifications	22
4.4 Power Supply Options	22
5. Firmware	23
5.1 Top Level Architecture.....	23
5.1.1 Top Level Design	24
5.2 Application Descriptions	26
5.2.1 Punch Gauge Accelerometer Algorithm	26
5.2.1.1 At Rest Peak and Hold.....	26
5.2.1.2 Punch Peak and Hold	26

5.2.2	Temperature Measurements	26
5.2.2.1	Temperature Sensing Design Principle.....	27
5.2.3	RTC Crystal and Clocking	27
5.2.4	Contrast Adjustments	28
5.2.5	LCD Demonstration	28
5.3	Project Design and Setup.....	28
5.3.1	Analog I/O	28
5.3.1.1	Thermistor Reference Voltage	28
5.3.1.2	Thermistor Signal Voltage.....	29
5.3.1.3	Accelerometer Y-Axis.....	30
5.3.1.4	Accelerometer X-Axis.....	31
5.3.1.5	Battery Monitor - 9V Level.....	32
5.3.2	Analog MUX	34
5.3.3	VDAC	34
5.3.4	Delta-Sigma ADC	35
5.3.5	PWM.....	36
5.3.5.1	PWM 6 kHz Clock Source.....	37
5.3.5.2	Logic High for PWM Kill Pin	38
5.3.5.3	Logic Low for PWM Reset Pin	38
5.3.6	Timer	38
5.3.7	Timer 1 kHz Clock Source.....	39
5.3.7.1	Logic Level Low for Timer	40
5.3.7.2	Timer ISR.....	40
5.3.8	Segment LCD.....	41
5.3.8.1	LCD Glass Character Pixel Mapping	42
5.3.8.2	LCD Glass Icon Pixel Mapping	46
5.3.8.3	Pixel Only Mapped Icons	48
5.3.9	Digital I/O.....	48
5.3.9.1	Sleep Button	48
5.3.9.2	Sleep Button ISR	50
5.3.9.3	Wall Supply (Vin) Detect	51
5.3.9.4	VBus Detect	53
5.3.9.5	Digital Outputs.....	54
5.3.9.6	Accelerometer On	54
5.3.9.7	Buzzer In	55
5.3.9.8	Logic Level High for Buzzer In Output Enable	56
5.3.10	Real Time Clock (RTC)	57
5.3.10.1	CapSense Buttons	57
5.3.11	EEPROM.....	60
5.3.12	System Clocks.....	61
5.3.13	Pin Mapping	62
5.3.14	Low Power Operation	64
5.3.15	Low Power Entry	64
5.3.16	Automatic Low Power Entry	65
5.3.17	Manual Low Power Entry	65
5.3.18	Periodic Wake and Return to Sleep	65
5.3.19	Wake from Sleep	65
5.3.20	Low Power Exit.....	65
5.4	Source Code Description	66
5.4.1	Top Level Functional Description	66
5.4.1.1	Main Loop	66
5.4.1.2	Punch Gauge Mode	67
5.4.1.3	RTC/TEMP.....	68
5.4.1.4	Contrast Control Mode.....	70
5.4.1.5	LCD Demonstration Mode.....	71
5.4.1.6	Register Descriptions	72

1. Introduction



Thank you for purchasing the CY8CKIT-006 PSoC[®] 3 LCD Segment Drive Evaluation Kit (EVK). This is an evaluation kit aimed at showcasing PSoC's LCD segment drive system. It familiarizes users with the LCD segment drive capability of Cypress's Programmable System-on-Chip (PSoC) and the LCD segment drive component in Cypress's Integrated Development Environment (PSoC[®] Creator™).

The kit has the following features:

- Large complex custom LCD with 448 LCD segments
- CapSense buttons
- Accelerometer
- Thermistor
- Buzzer
- Protoheaders

The kit is factory programmed for an out-of-box demonstration of PSoC's LCD segment drive capability, along with PSoC's superior ability to integrate high performance digital and analog peripherals. You can also reprogram the device and using the protoheaders, develop applications.

The CY8CKIT-006 PSoC 3 LCD Segment Drive EVK is based on the PSoC[®] 3 family of devices. PSoC is a programmable system-on-chip platform for 8, 16, and 32 bit applications. It combines precision analog and digital logic with a high performance 8051 single cycle per instruction pipelined processor, achieving ten times the performance of previous 8051 processors. With the PSoC, you can create the exact combination of peripherals and integrated proprietary IP to meet the needs of your applications. You are no longer constrained by a catalog.

1.1 Kit Contents

This kit contains:

- PSoC 3 LCD Segment Drive Evaluation Board
- 9V Battery
- 12V Wall Wart Power Supply
- Minipro3
- USB Cable (to connect Minipro3 to the PC)
- Kit Stand
- Quick Start Guide
- Resource CD

Inspect the contents of the kit; if you do not find any part, contact your nearest Cypress sales office for help.

1.2 PSoC Creator

Cypress's PSoC Creator software is a state-of-the-art, easy-to-use software development IDE that introduces a game-changing, hardware and software co-design environment based on classical schematic entry and revolutionary embedded design methodology.

With PSoC Creator, you can:

- Automatically place and route select components and integrate simple glue logic normally residing in discrete muxes.
- Trade-off hardware and software design considerations allowing you to focus on what matters and getting to market faster.

PSoC Creator also enables you to tap into an entire tools ecosystem with integrated compiler tool chains, RTOS solutions, and production programmers to support both PSoC 3 and PSoC[®] 5.

1.3 Getting Started

To get started, take a look at Chapter 3 for a description of the kit operation and how to reprogram the device through PSoC Programmer. Refer to the installation instructions that comes with the PSoC Creator software to reprogram the device directly from PSoC Creator. Chapters 4 and 5 provide details on the theory of operation of the hardware and firmware, respectively. The Appendix provides the schematics and BOM associated with the PSoC 3 LCD segment drive evaluation board.

1.4 Additional Learning Resources

Visit www.cypress.com for additional learning resources in the form of data sheets, technical reference manual, and application notes.

1.5 Document History

Revision	PDF Creation Date	Origin of Change	Description of Change
**	04/29/09	TEH	Initial version of kit guide
*A	09/22/09	XKJ/TEH	Extensive content updates
*B	11/09/09	KEV	Updates to text and images for Beta3 release
*C	01/08/10	KEV	Updates to section 3 for Beta4 web release

1.6 Document Conventions

This guide uses the Courier New font to distinguish file names and file location from regular text. The keyboard commands and window selections are given in bold text.

2. Installation



2.1 CD Installation

Follow these steps to install the CY8CKIT-006 PSoC 3 LCD Segment Drive EVK software:

1. Insert the kit CD into the CD drive of your computer. The CD is designed to auto-run and PSoC 3 LCD Segment Drive EVK menu appears.
2. The installation allows you to install the following software:
 - PSoC Creator
 - PSoC Programmer
 - Kit Documentation
 - Quick Start Guide
 - User Guide
 - Firmware
 - Demonstration Firmware
 - Example Projects
 - Hardware
 - Schematic
 - Layout
 - BOM

Note If auto-run does not execute, double click **AutoRun** in the root directory of the CD.

2.2 Hardware

WARNING: Static discharges from the human body can easily reach 20,000 volts. This can damage the PSoC 3 LCD Segment Drive Evaluation Kit hardware. Take precautions to ensure that any static is discharged before touching the hardware.

1. Ensure that switch SW1 is in the OFF position prior to adding or removing batteries.
2. Insert a battery into the appropriate terminals or connect a wall transformer to the J2 jack.
3. Slide SW1 to the ON position if using a battery. The wall transformer supply is not controlled by SW1 and is always ON.

2.3 Software

- CY8CKIT-006 PSoC 3 LCD Segment Drive Evaluation Kit
- PSoC Creator IDE
- PSoC Programmer 3.10
- Example Project at
C:\Program Files\Cypress\CY8CKIT-006_PSoC3_LCD_Drive_Kit\1.0\Firmware
- Documents at
C:\Program Files\Cypress\CY8CKIT-006_PSoC3_LCD_Drive_Kit\1.0\Documentation
- Schematic design files at:
C:\Program Files\Cypress\CY8CKIT-006_PSoC3_LCD_Drive_Kit\1.0\Hardware

3. Kit Operation



3.1 Introduction

The CY8CKIT-006 PSoC 3 LCD Segment Drive EVK firmware provides examples using a display with many segments (16 common lines by 28 segment lines giving 448 addressable segments).

Figure 3-1. CY8CKIT-006 Kit

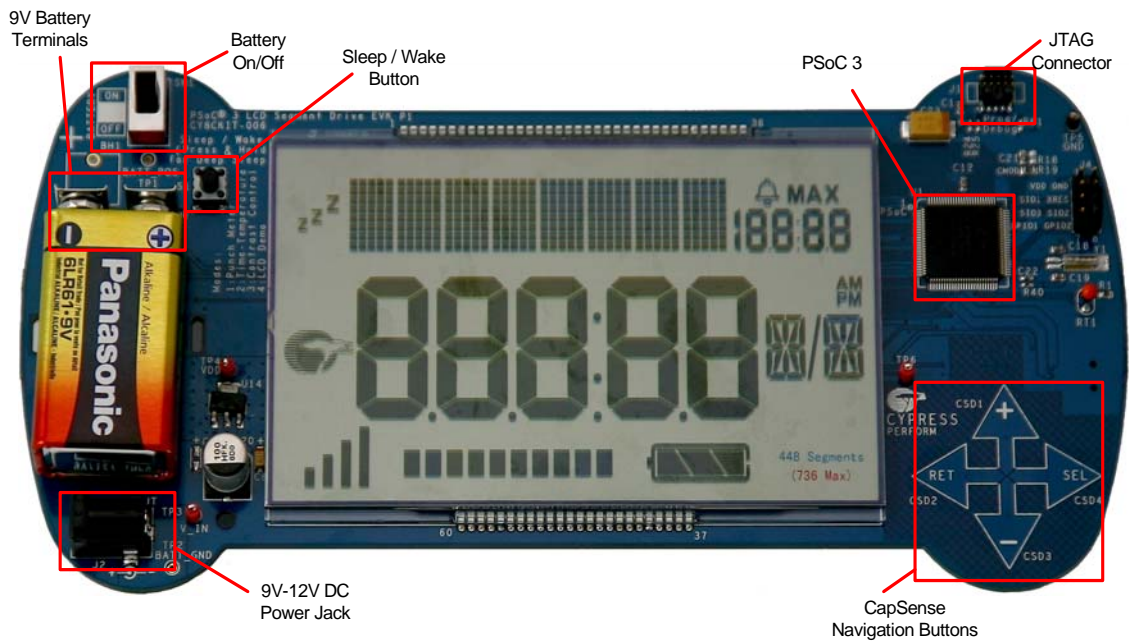

Operator entries are made using the four CapSense buttons that are labeled: SEL, "+", "-", and RET.

Table 3-1. CapSense Button Functionality

Button	Function
SEL (CSD4)	Enter menu levels and select items
"+" (CSD1)	Advance up through menu items
"-" (CSD3)	Advance down through menu items
RET (CSD2)	Return to previous menu levels

3.2 Main Menu

Supply power to the board either through 9V battery, 9V to 12V wall adaptor, or USB. Refer to [Power Supply Options on page 22](#) for more information on options to power the board. On startup, the kit name is scrolled from right to left across the matrix display. When the scrolling is complete, "Push SEL" is flashed to prompt you to press the CapSense Select button. After pressing **SEL**, the first main menu selection, PUNCH is shown on the matrix display. Press the "+" or "-" CapSense buttons to select a mode from one of the main menu selections.

Table 3-2. Main Menu Options

Option	Brief Description
PUNCH	Punch gauge
RTC/TEMP	Real Time Clock Time/Temperature Display with Set Time/Date/Alarm
CONTRAST	Set LCD contrast level
LCD DEMO	Display all icons and segment characters in sequence

To select a mode, press **SEL** when the desired mode name is displayed.

3.3 PUNCH

If you select PUNCH, the project enters the Punch menu item. PUNCH automatically enters the GAUGE sub menu and prompts by scrolling "Push SEL to Start Gauge". If you press the **SEL** button, then the PUNCH Gauge continues ([1:GAUGE on page 10](#) section). By pressing the **RET** button, the PUNCH returns to its sub menu selections. Pressing "+" or "-" allows you to select a Punch sub menu option. The sub menu options are entered by pressing **SEL**.

Table 3-3. PUNCH submenu options

Option	Brief Description
1:GAUGE	Record a punch acceleration.
1:HIGH	View the current high score.
1:RECALL	View the recorded top five high scores and the average score.
1:CLEAR	Clear the saved high scores.

After exiting a Punch sub menu option and returning to the Punch menu, you can either select another Punch sub menu or press **RET** to return to the Main Menu.

3.3.1 1:GAUGE

If you select GAUGE, the display scrolls "Push SEL to Start Gauge". When you press **SEL**, a punch recording session begins. The project automatically starts measuring the peak at rest acceleration of the LCD kit board. During this time, the project displays a three second count down ending in the phrase "PUNCH!". Then the project begins peak and hold acceleration measurements in a continuous loop. During this sampling period, the "Push SEL" prompt is flashed. You can hold the board and "throw" punches. After throwing one or more punches, press the **SEL** button. The project displays the peak acceleration that the board experienced during the punch time.

If the peak acceleration is less than 1G, then the score is displayed as 0.0G. The peak acceleration is displayed on the large 7-segment display in the form X.X with a "G" shown on the 16-segment display (for example, 4.6G). If the peak acceleration is greater than the current lowest score, then the project prompts you to enter a name. **Note** The first five scores after performing a Clear (see [1:CLEAR on page 11](#)) are always recorded. An empty score has a 0G value in the test for lowest score.

A name is one to six alphabetic characters and is entered on the matrix display. The project flashes "Name". Press **SEL**; "A" is flashed across the display. Press "+" and "-" buttons to select a letter in the range "A" to "Z". Press the **RET** button to select a single character name or press **SEL** to enter a second letter. You can enter up to six letters. A short name can be entered by pressing **RET** twice. This enters the name for the characters currently selected and entered.

After entering a user name, the project scrolls the saved high scores along with the name for each high score, from right to left on the matrix display. Then it scrolls the final average score. If your score is the first one entered after the score structure was cleared, then that score and the average score is displayed. In this case, the average score equals user score. The recalled scores continue to scroll until you press **SEL** to start another Punch recording or **RET** to exit the Punch Gauge sub menu and return to the Punch menu.

3.3.2 1:HIGH

When the option 1:HIGH is selected, the project scrolls the name and score of the highest recorded score. The project can store up to five high scores and user entered associated names. This score data structure is stored in persistent memory on the PSoC 3 and is returned through power cycles.

The high score and name are scrolled from right to left continuously on the matrix display in the format "1:MAX SCORE - ABCDEF = X.XG", where ABCDEF is the name of the highest scorer and X.XG is the high score acceleration value.

To exit the HIGH sub menu and return to the Punch menu, press the **SEL** or **RET** buttons.

3.3.3 1:RECALL

When the 1:RECALL option is selected, the project scrolls the five stored high score values along with names. Following the high scores, the average of the high scores is scrolled from right to left across the matrix display.

The first stored high score is displayed as "1: <Name-string> =<score - string>" followed by next high score user name and score value and finally the average of the high scores as "A: AVG SCORE = <score - string>".

Example of <Name string> is JAYA and <score sting> is 5.8G

To exit this sub menu and return to the Punch menu, press the **SEL** or **RET** buttons.

3.3.4 1:CLEAR

When the option 1:CLEAR is selected, the project prompts you to either complete the Clear function or exit to the Punch menu. The Clear function scrolls the instructions "Press SEL to clear or Press RET to abort" from right to left across the matrix display continuously until you press **SEL** or **RET**.

When **SEL** is pressed, the project clears saved score records, exits the Clear sub menu, and returns to the Punch menu (this also clears the RTC alarm settings and the RTC date).

If you press **RET**, the project returns to the Punch menu without clearing the saved scores.

3.4 RTC/TEMP

The RTC/TEMP menu has five sub menus.

Table 3-4. RTC/TEMP Sub Menu Options

Option	Brief Description
2:Clock	Show time, date, and temperature
2:SetTim	Enter time of day
2:SetDat	Enter calendar date
2:SetAlm	Enter alarm time of day
2:Alarm	Turn alarm on/off

Press "+" or "-" to select one of the sub menu items and then **SEL** button to enter the sub menu options.

If you press the **RET** button at anytime in the RTC/TEMP sub menu, the project returns to the RTC/TEMP main menu.

3.4.1 2:Clock

This sub menu displays the current time on large 7-segment display with AM/PM displayed on the 16-segment and 14-segment displays. The colon separator in the 7-segment display flashes on/off automatically marking seconds (one second on; one second off). If the time is set, then it is displayed as 12-hour time with AM or PM. If the time is not set since the last power cycle, the time at the minute that the power was last turned off will flash on/off. Press **SEL** to stop the flashing, but verify the time is correct.

If the alarm is turned on, then the alarm time is displayed on the small 7-segment display with either the small AM or PM icons displayed along with the BELL icon. If the alarm is off, then all the alarm display elements are turned off.

Date and temperature are displayed on the matrix display. The date and temperature are flashed one after the other. The temperature display can be alternated between °C and °F by pressing the "+" or "-" buttons.

When the alarm sounds, press **SEL** to stop the alarm. Press **RET** to return to the RTC/TEMP main menu.

3.4.2 2.SetTim

This submenu allows to set the clock time of the day.

Enter H1H2:M1M2 in 12 hour AM/PM clock time. The clock time is entered and displayed on the large 7-segment displays using the four display characters to the right and the colon icon separating the H1H2 and M1M2 characters. AM and PM are displayed on the 16-segment and 14-segment display characters.

- The project displays 12:00 the first time that time is set; the left H position (H1) of the large 7-segment display is flashed.
- Press "+" or "-" button to select the higher hour digit, '0' or '1'.
- Press **SEL** to advance to the next H position (H2).
- Press "+" or "-" to select '0' - '9' if H1 is '0' or to select '0' - '2' if H1 is '1'.
- Press **SEL** to advance to the left M position (M1).
- Press "+" or "-" to select '0' - '5'.
- Press **SEL** to advance to the next M position (M2).

- Press "+" or "-" to select '0' - '9'.
- Press **SEL** to advance to the 16-segment display character.
- Press "+" or "-" to select 'A' - 'P'. The 14-segment display character shows 'M'.
- Press **SEL** to enter the time settings. "Push SEL" is prompted on the matrix display.
- Press **SEL** to exit the SetTim sub menu.

When setting the time, pressing **RET** exits the SetTim sub menu immediately without saving the time information.

3.4.3 2:SetDat

This sub menu allows to set the date in the format DDMMM-YY.

Enter D1D2MMMABC - Y1Y2. The date is displayed on the matrix display. This application only displays the last two digits of the year, the year "00" is taken as the year 2000 which is handled as a leap century.

- The project displays the 01JAN-00 the first time the time is set, the left D position (D1) of the matrix display is flashed.
- Press "+" or "-" button to select the higher date digit of the month, '0' - '3'.
- Press **SEL** to advance to the next D position (D2).
- Press "+" or "-" to select '0' - '9'.
- Press **SEL** to advance to select the month of the year.
- Press "+" or "-" to select month names, from "JAN" - "DEC".
- Press **SEL** to advance to the left Y position (Y1) of the year.
- Press "+" or "-" to select '0' - '9'.
- Press **SEL** to advance to the next Y position (Y2).
- Press "+" or "-" to select '0' - '9'.
- Press **SEL** to enter the date settings and return to the "RTC/TEMP" sub menu.

If the day is set for a day greater than the number of days in the selected month, then the project automatically adjusts the day down to 30 or 31 or down to 28 or 29 for February depending on whether the entered year is a leap year.

When setting the date, pressing **RET** exits the SetDat sub menu immediately without saving the date information.

3.4.4 2:SetAlm

This sub menu allows to set the clock alarm time of the day.

Enter H1H2:M1M2 in 12 hour AM/PM alarm clock time. When setting the alarm, the alarm time is displayed on the large 7-segment display characters using the large colon icon to separate the H1H2 and M1M2 characters. AM and PM are displayed on the 16-segment and 14-segment display characters.

- The project displays the 00:00 the first time the alarm is set; the left H position (H1) of the large 7-segment display is flashed.
- Press "+" or "-" to select '0' or '1'.
- Press **SEL** to advance to the next H position (H2).
- Press "+" or "-" to select '0' - '9' if H1 is '0' or '0' -'2' if H1 is '1'.
- Press **SEL** to advance to the left M position (M1).
- Press "+" or "-" to select '0' - '5'.

- Press **SEL** to advance to the next M position (M2).
- Press "+" or "-" to select '0' - '9'.
- Press **SEL** to advance to the 16-segment display character.
- Press "+" or "-" to select AM or PM.
- Press "+" or "-" to select 'A' - 'P'. The 14-segment display character shows 'M'.
- Press **SEL** to enter the alarm settings. "Push SEL" is prompted on the matrix display.
- Press **SEL** to exit the "SetTim" sub menu.

The alarm time is set for the HH:MM selected and the SS is set to 00 by the code. The RTC Alarm interrupt is enabled.

When setting the alarm, pressing **RET** exits the SetAlm sub menu immediately without saving the alarm information

3.4.5 2:Alarm

This sub menu allows to turn the alarm on/off. Upon entering, either "AlarmOFF" or "AlarmON" is displayed based on the current alarm on/off settings.

- Press "+" and "-" button to select "AlarmOFF" or "Alarm ON".
- Press **SEL** to enter the ON/OFF alarm state. "PushSEL" is prompted on the matrix display.
- Press **SEL** to exit the Alarm set sub menu.

In the clock mode, alarm symbol is displayed if alarm is enabled. When the time reaches the set alarm time, the buzzer present on the board will beep. The buzzer will sound for up to 2-minutes before automatically shutting off. If the buzzer is shut off automatically, then the alarm remains on and starts the buzzer the next time the alarm time is reached again. You can manually turn off the alarm in three ways:

1. Press the sleep pushbutton from any state.
2. Press any CapSense button (for example, **SEL**) from any state.
3. Reopen the 2:Alarm sub menu item and set the Alarm state to "OFF".

3.5 CONTRAST

The project is designed for 3.3V operation and this bias level is set in the SegLCD component of the design. The CONTRAST sub menu allows the selection of a value in the range 0 to 10 to set the bias higher or lower to allow viewing the contrast effects.

Press **SEL** to enter the CONTRAST sub menu. The project displays the current contrast setting on the matrix display in the format "Level= X", where X is a value in the range 0 to 10. Press "+" or "-" to increment or decrement the value displayed. The progress bar at the bottom displays the contrast level in graphical format.

Pressing **SEL** or **RET** stores the contrast level in the persistent memory and project returns to the CONTRAST sub menu.

3.6 LCD DEMO

The LCD demonstration shows all the characters, icons, and the range of characters in an automated animation that advances through all characters and icons in sequence culminating in all characters and icons on at the same time.

You can skip sequences in the demonstration to quickly get to the end where all segments are turned on. To skip a sequence, press the **SEL** button.

After showing all the characters and icons, "Push SEL" is flashed on the matrix display. To exit the demonstration and return to the main menu, press the **RET** button.

3.7 Restore Default Firmware

This kit is delivered with the firmware already programmed onto the PSoC 3 silicon. However, if the silicon is erased or replaced, or if a new version of the project is constructed, you can reprogram the kit using PSoC Programmer and the MiniProg3. To program and debug the project interactively, refer to the instructions included with the PSoC Creator software, which is installed by this kit CD.

Here is how to program this project onto the hardware PSoC 3 silicon:

1. Install the kit CD software. This installs PSoC Creator and PSoC Programmer 3.10.
2. Open PSoC Programmer from the Program menu or the installed location on your PC.
3. Connect the Minipro3 JTAG cable to the JTAG connector on the MiniProg3 and to the JTAG connector on the PSoC 3 LCD kit board. Next, connect the kit MiniProg3 to a host PC USB High Speed port using the kit USB cable.
4. After the MiniProg3 is automatically selected by the Programmer, verify and adjust the Programmer settings shown in [Figure 3-2](#).
5. Select the **File > File Load** menu, and choose the demonstration project file from the example project directory: `C:\Program Files\Cypress\CY8CKIT-006_PSoC_3_LCD_Drive_Kit\1.0\Firmware\SegLCD_project\SegLCD_project.cydsn\DP8051-Keil_Generic\Debug\SegLCD_project.hex`

Note The MiniProg3 version numbers may be higher numbers based on release. You should include these version numbers in any request for assistance from Cypress Semiconductor.

Figure 3-2. PSoC Programmer MiniProg3 Port Selection

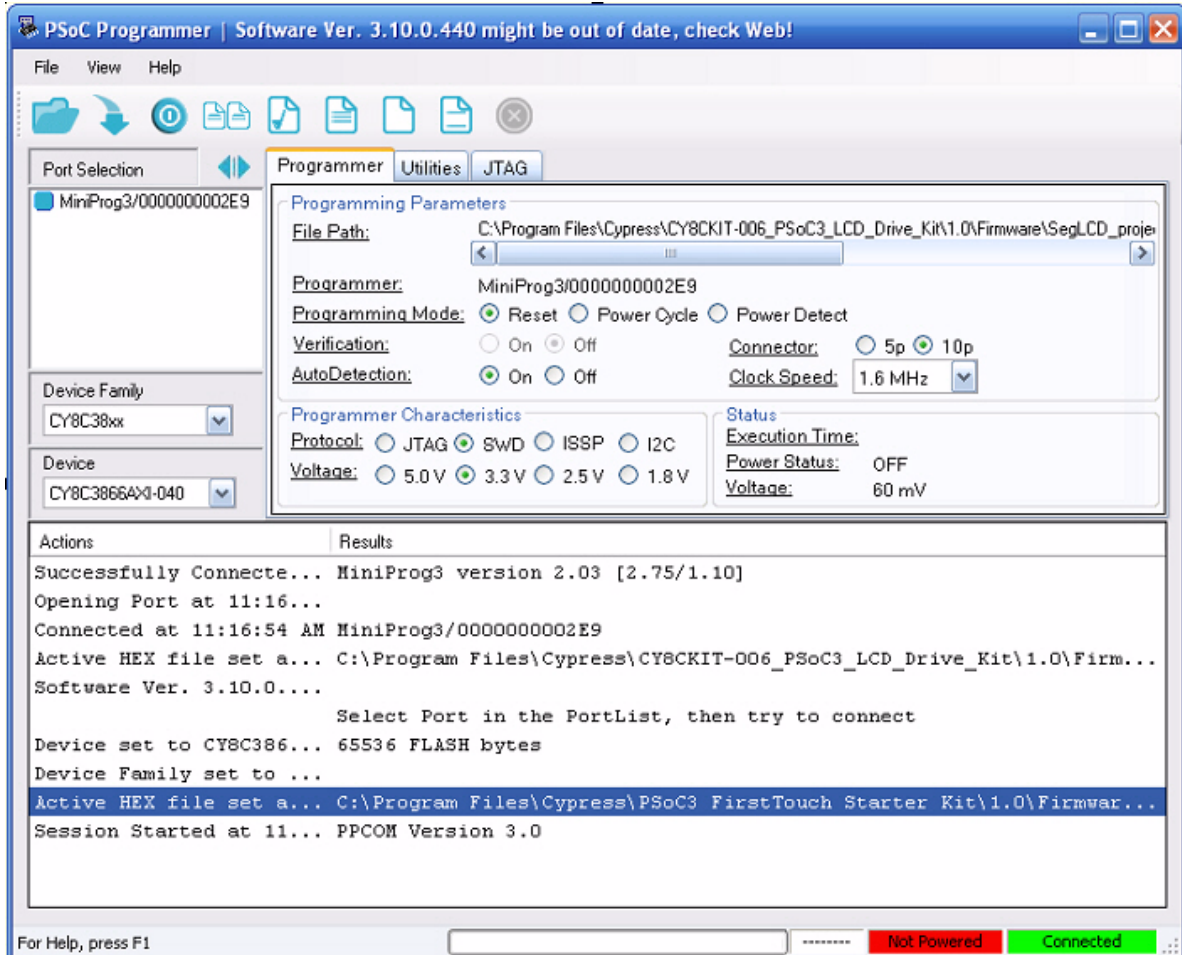

6. Power the LCD kit board using either battery connections or a wall power unit.
7. Verify that the Powered status is green as shown in [Figure 3-3](#).
8. Select **File > Program** to download the kit project to the PSoC 3 silicon.
9. When the program is successfully downloaded, a "Programming Succeeded" message is displayed in the programmer window as shown in [Figure 3-3](#).
10. Rest the device by plugging out and plugging in the power to the board

Figure 3-3. Program Download Succeeded

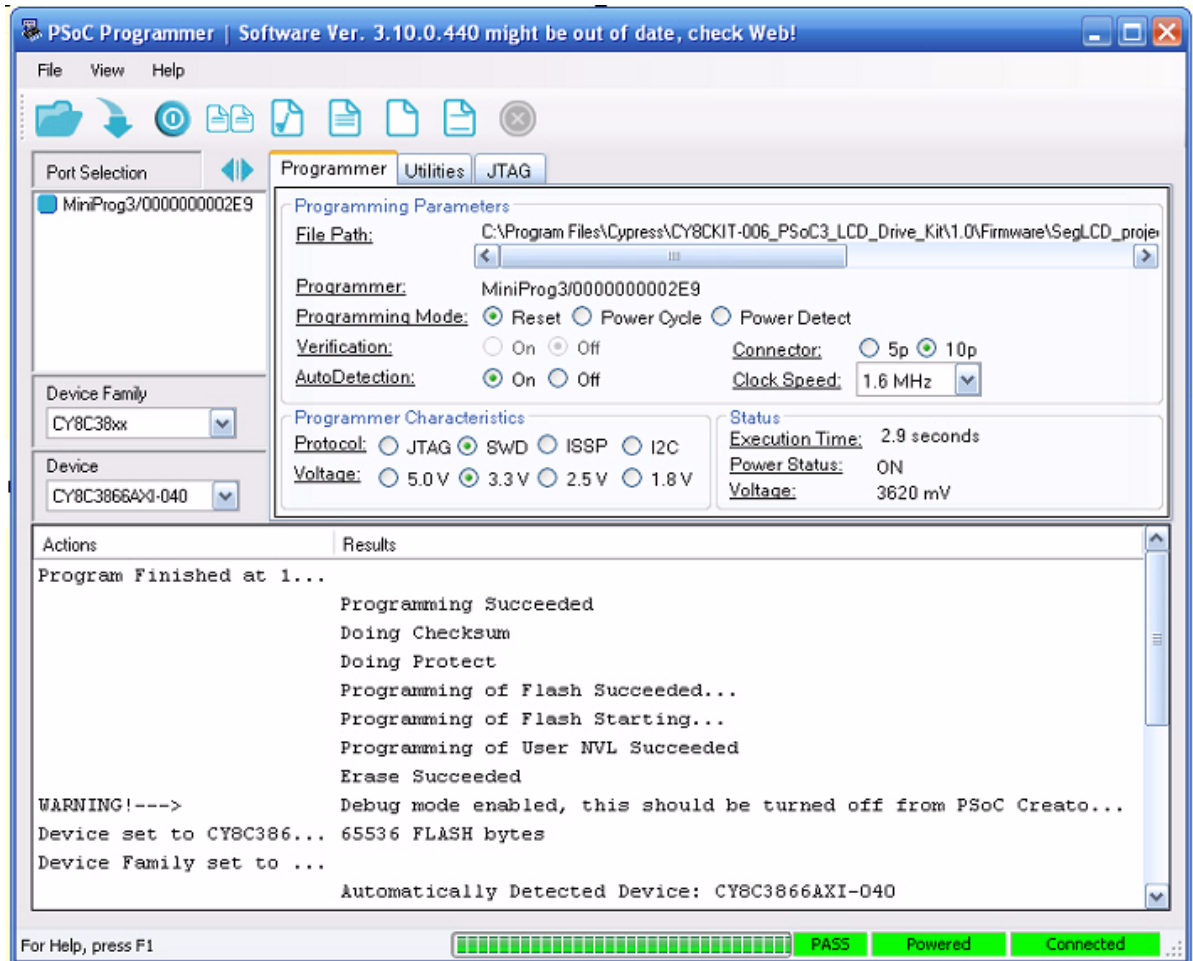

3.8 Example Projects

Refer to Application Note AN52927, *LCD Direct Drive Basics*, for steps to create a simple example project with this kit.



4. Hardware



4.1 System Block Diagram

Figure 4-1. System Block Diagram

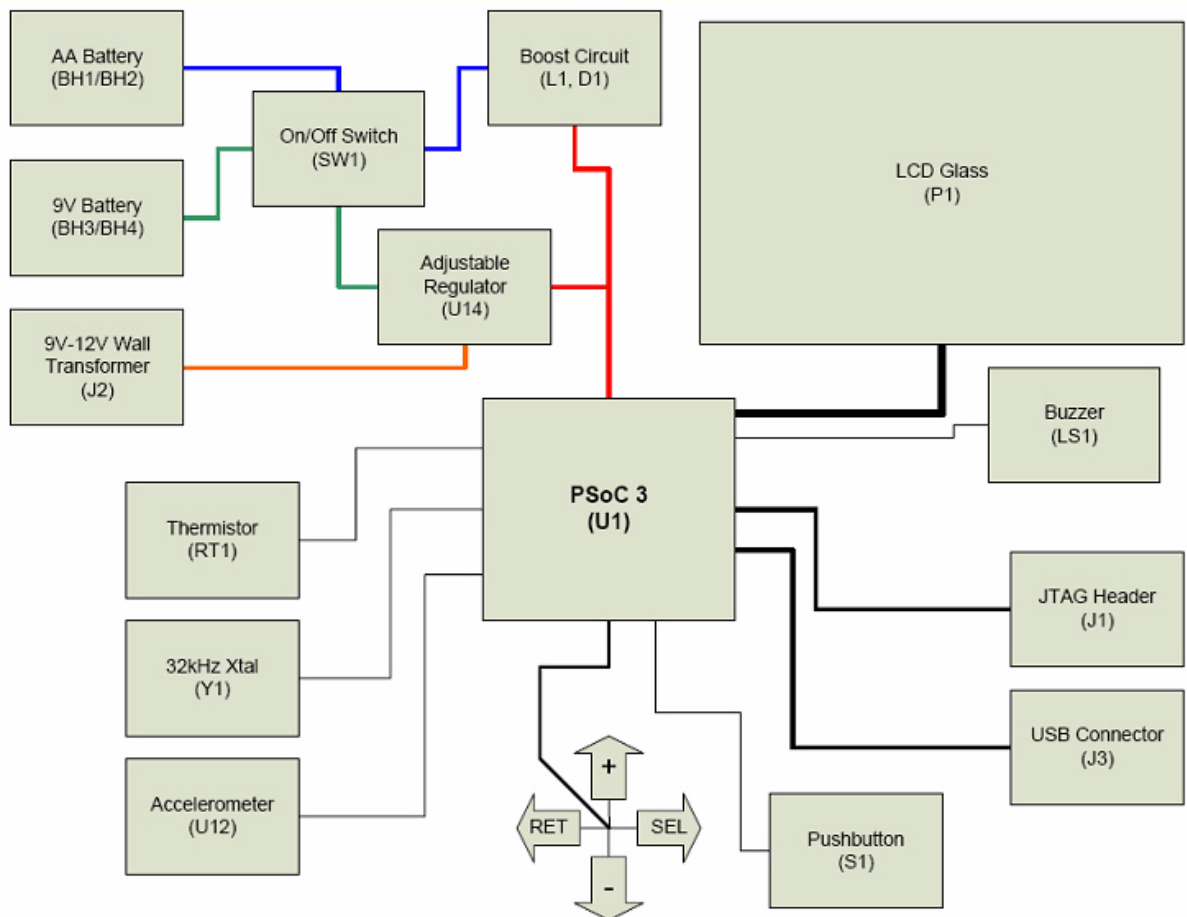

PSoc 3 LCD Segment Drive EVK showcases PSoc's LCD segment drive capability by driving a custom glass with 448 segments (16 common lines by 28 segments lines). This kit also highlights the PSoc's superior ability to integrate high performance digital and analog peripherals by integrating the accelerometer, thermistor, Real Time Clock, CapSense, and buzzer.

Refer to [Functional Description on page 21](#) to know about functional implementation of the applications.

4.2 Operation Theory - All Components

Sl. No.	Device Features	Description
1	Slide Switch (SW1)	This switch turns the power supplied by the battery On and Off. Note Switch (SW1) does not control the power supplied by sources through J1(USB) and J2(Wall Power).
2	Pushbutton Switch (S1)	This switch is used to enter (Switch - On) and exit (Switch-Off) the sleep modes. Note The project supports all the sleep features described with the exception that PSoC 3 device does not go to sleep; the firmware is just put in a low power mode.
3	LCD Glass (P1)	Provides visual feedback. Custom made glass with 448 segments. Refer to LCD Glass on page 21 for glass details.
4	CapSense Buttons: CSD1 (Labeled as '+') CSD2 (Labeled as 'RET') CSD3 (Labeled as '-') CSD4 (Labeled as 'SEL')	CapSense buttons are used to navigate through various modes of operation. Table 3-1 on page 9 , explains the function of CapSense buttons for each mode of operation.
5	Accelerometer (Memsic MXR2010A (U12))	The dual axis accelerometer is used to detect the movement and calculate the force of a punch. Accelerometer has a range of $\pm 35G$ at 5V/25°C and can measure both static and dynamic acceleration.
6	Buzzer(CUI CMT -1603 (LSI))	It provides audible feedback to the user. A 5V, 4 kHz square wave is applied to the buzzer's input to produce sound.
7	Thermistor (RT1)	It is used to detect the ambient temperature for use in the Time/Temp demonstration mode. The default firmware supports a 10k thermistor rated to $\pm 0.75\%$ at 25°C.
8	RTC Crystal (Y1)	This external crystal is used as a 32.768 kHz clock source for maintaining real-time operation in the Time/Temp demonstration mode.
9	GPIO Connector(J4)	The header (J4) provides 3 SIO, 2 GPIO, XRES, VDD, and GND signals, thereby facilitating users to develop their own application. Refer to Hardware Schematic and PSoC 3 data sheet for specific details regarding the SIO and GPIO pins connected to these signals.
10	JTAG MiniProg3 Connector (J1)	The J1 connector provides a programming and debugs connection between the PSoC 3 and MiniProg3 programmer. Note Minipro3 can be used to supply the power to the board for programming, but this is not recommended for normal or debugs operation.

4.3 Functional Description

4.3.1 LCD Glass

Figure 4-2 shows the image of the LCD Glass and Table 4-1 lists the segments details.

The LCD glass provides visual feedback to the user based upon the current mode of operation.

Figure 4-2. LCD Glass Image

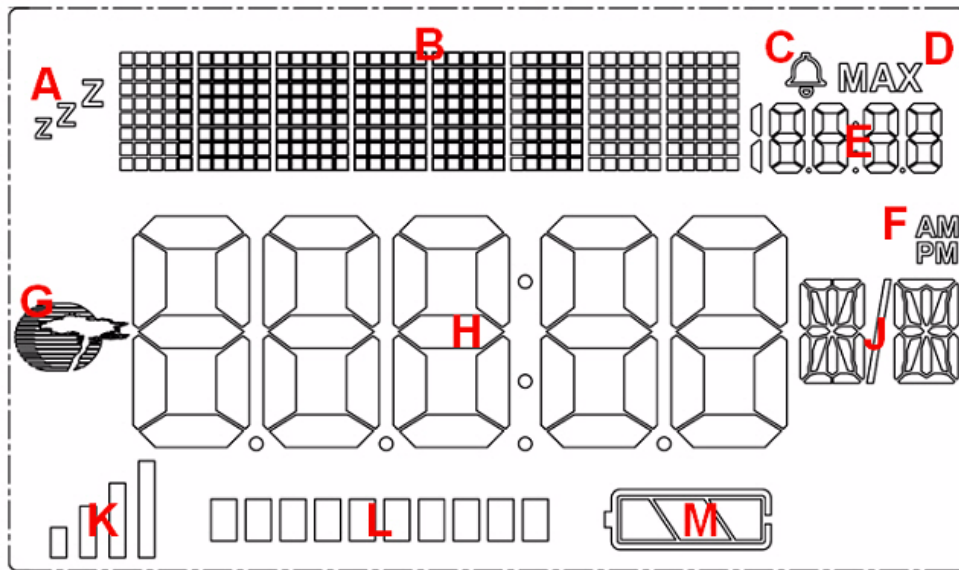

Table 4-1. LCD Glass Segment Details

Label	Description
A	Sleep Indicator
B	8X5 Dot-Matrix Display Area
C	Alarm Indicator
D	MAX Indicator
E	Small Seven - Segment Display
F	AM/PM Alarm Indicator
G	Cypress Logo
H	Large Seven - Segment Display Area
J	16/14 Segment Display Area
K	Signal Strength Bars
L	Progress Bars
M	Battery Level Bars

4.3.1.1 Glass Specifications

The specifications for the LCD glass are as follows:

- Display Type: FSTN
- Viewing Direction: 6 o'clock
- Drive Method: 1/16 Duty, 1/5 BIAS
- Operating Voltage: 3.3V
- Polarizer Mode: Reflective/Positive
- Operating Temperature: 0 ~ +50°C
- Storage Temperature: -10 ~ +60°C

Note Refer to [Pixel Mapping Table for LCD Glass](#) on page 73.

4.4 Power Supply Options

The kit can be powered by only one of the three voltage sources.

Sl. No.	Description	Typical Voltage	Connection	Switch - SW1
1	Battery	9V	BH3, BH4	On (Up position) Note SW1 disconnects the 9V battery from the 5V regulator.
2	Wall Power	9V to 12V (100 mA minimum)	J2	Don't care.
3	USB Power	5V	J3	Don't care.

5. Firmware



5.1 Top Level Architecture

Figure 5-1. Top Level Architecture

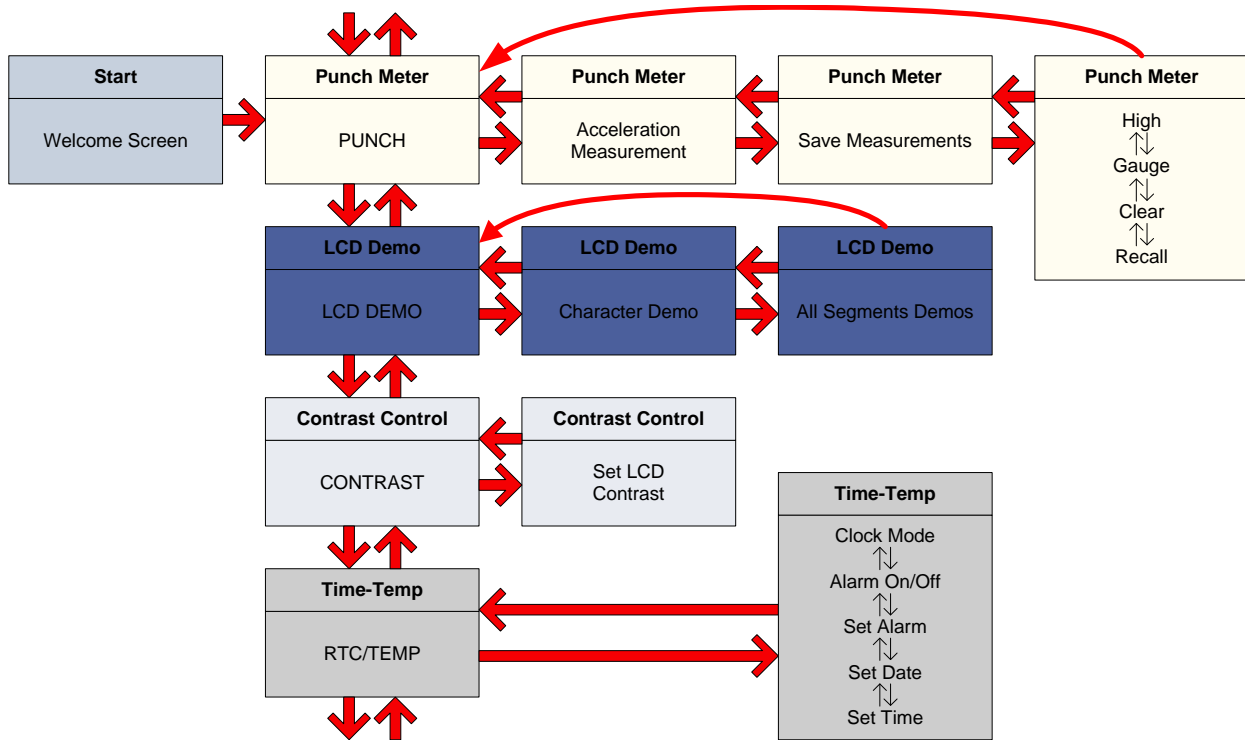

5.1.1 Top Level Design

The top level schematic for the project is shown here.

Figure 5-2. PSoC Creator Top Level Design for Firmware

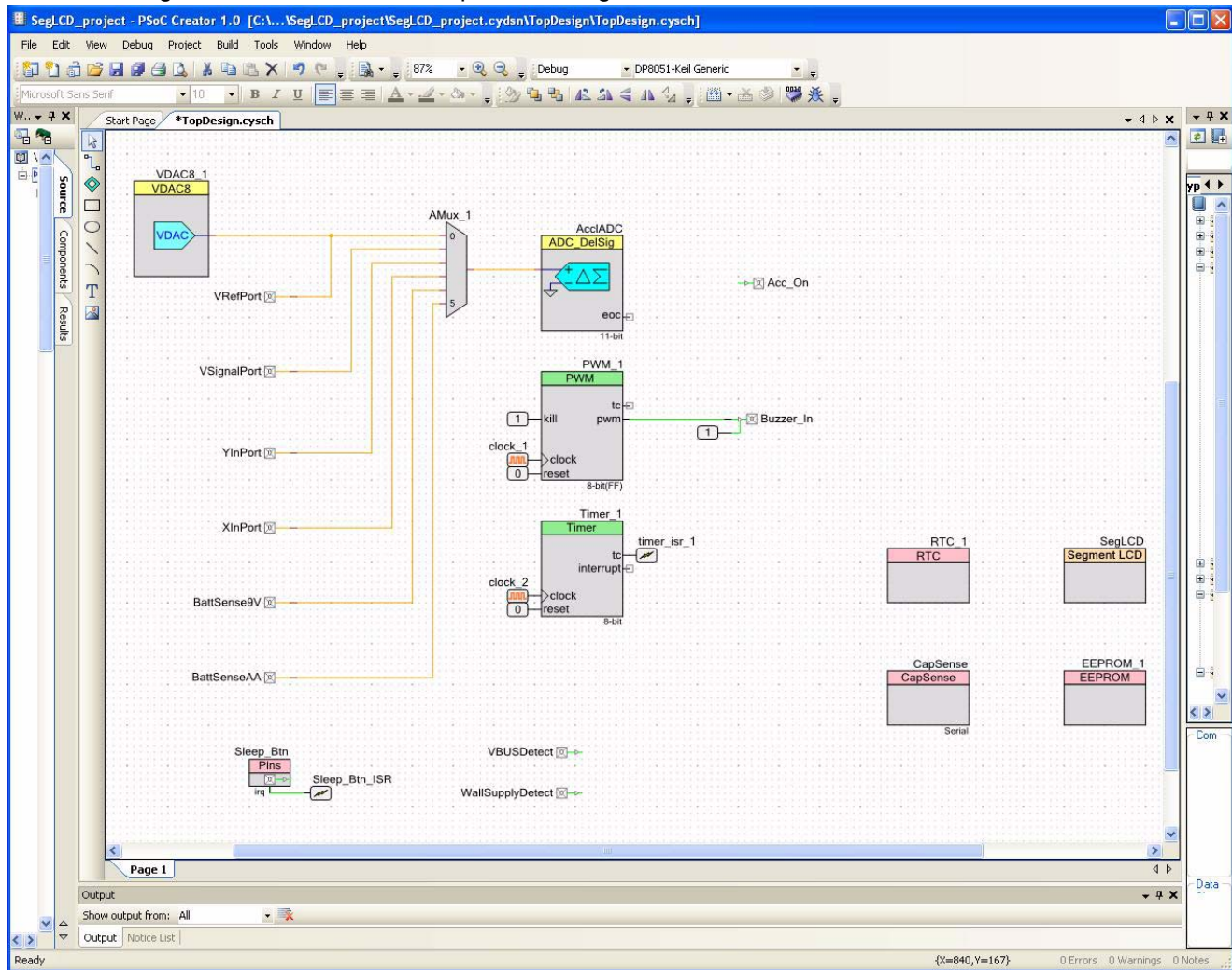

The PSoC Creator project has the following timer components:

- Analog outputs:
 - Thermistor reference voltage (also an output for the reference voltage generator VDAC)
- Analog inputs:
 - Thermistor reference voltage - output of VDAC to AMUX input
 - Thermistor signal voltage
 - Accelerometer Y-axis
 - Accelerometer X-axis
 - Battery level - 9V
 - Battery level - AA
- Analog mux (AMUX): 6 input
- VDAC to generate reference voltage for thermistor

- Delta-Sigma ADC to convert one of the six inputs from the AMUX
- PWM to drive the buzzer:
 - 6 kHz clock for PWM
 - Logic level High for PWM Kill
 - Logic level Low for PWM Reset
- Timer to generate 100 mS timing intervals: Timeout timers, No-activity timer, Blink timer
 - 1 kHz clock for timer
 - Logic level Low for Timer Reset
 - Timer ISR
- Segment LCD: Defines character sets and helpers to allow API access to display elements. The icon designators show the mapping to the segment symbol name applied to the segment in the FEMA Electronics drawing number S93043-0-FRPC. This drawing is included in this kit in the hardware design file *93043-602.pdf*. These designators are shown on page 2 of the file.
 - CyLogo icon (1) (icon P6)
 - Matrix characters (8)
 - Large 7-segment characters (5)
 - Large colon icon (1) (icon COL)
 - Large decimal point icons (4) (icons T5, T6, T7, T8)
 - 16-segment character (1)
 - Slash icon (1) (icon T9)
 - 14-segment character (1)
 - Small 7-segment characters (4)
 - Small '1' icon leading 7-segment display (1) (icon Z1)
 - Small colon icon (1) (icon Z4)
 - Small decimal point icons (3) (icons Z2, Z3, Z5)
 - BELL icon (1) (icon Z6)
 - MAX icon (1) (icon MAX)
 - AM icon (1) (icon AM)
 - PM icon (1) (icon PM)
 - ZZZ sleep icon (1) (icon P1)
 - Signal strength icons (4) (icons P7, P8, P9, P10)
 - Progress bar icons (10) (icons Q1, Q2, Q3, Q4, Q5, Q6, Q7, Q8, Q9, Q10)
 - Battery level icons (4):
 - Battery case icon (1) (icon T1)
 - Battery level icons (3) (icons T2, T3, T4)
- Digital Input:
 - PushButton
 - Go to sleep
 - Wake from sleep
 - Wall Supply (Vin) Detect - regulated supply input voltage detect
 - VBus Detect - USB VBus supply input voltage detect
- Digital Output:
 - Accelerator ON - firmware control

- Buzzer - hardware control
 - Logic level High for Buzzer OE
- RTC: Enable 32.768 RTC clock
- CapSense:
 - CMod connection
 - RBleed connection
- EEPROM: Persistent memory storage (saved scores, contrast level, clock settings)

5.2 Application Descriptions

5.2.1 Punch Gauge Accelerometer Algorithm

The Punch Gauge code runs a peak and hold algorithm in a tight loop continuously updating until there is a change in the program state. Both the X and Y-axis accelerometer outputs are sampled separately and continuously. The higher of the two axis measurements is reported as the score.

5.2.1.1 *At Rest Peak and Hold*

When the operator initiates a Punch Gauge punch, the punch code begins reading the instantaneous X and Y-axis accelerometer outputs for a period of three seconds. This is to measure maximum at rest acceleration that the board experiences. This is saved as a baseline for the punch measurement.

5.2.1.2 *Punch Peak and Hold*

After the Punch Gauge has stored the baseline at rest acceleration, the punch code begins continuously sampling both the X and Y-axis accelerometer outputs. The code continues to sample and hold the peak values until the operator terminates the operation by pressing **SEL** button. During this sampling period the operator "throws" a punch or punches. The algorithm continues to peak and hold until the operator presses **SEL** button.

When the **SEL** button is pressed, the punch code subtracts the at rest X-axis baseline reading from the punch X-axis peak reading and subtracts the at rest Y-axis baseline from the punch Y-axis peak reading. The greater of the X and Y-axis results is reported as the punch acceleration.

5.2.2 Temperature Measurements

The temperature sensing demonstration shows how the PSoC is used to sense temperature using a thermistor. The thermistor resistance varies with temperature following a predictable non-linear curve. The temperature-resistance relationship is given by the Steinhart-Hart equation:

$$1/T_k = A + B \cdot \ln(R) + C \cdot (\ln(R))^3$$

Where:

- A, B, and C are empirical constants known as Steinhart-Hart coefficients
- R is the resistance of the thermistor in Ohms
- T_k is the temperature in degree Kelvins

The same equation, when converted to Celsius scale is as follows:

$$T_c = T_k - 273.15; \text{ where } T_c \text{ is temperature in degree Celsius.}$$

The PSoC can measure the voltage across the thermistor but not the resistance value.

5.2.2.1 Temperature Sensing Design Principle

The device for temperature sensing uses a voltage divider with a precision resistor on one side and the thermistor on the other to estimate the thermistor resistance. This is shown in [Figure 5-3](#). The temperature calculations are as accurate as the resistance measurement of the thermistor.

Figure 5-3. Temperature Sensing Design

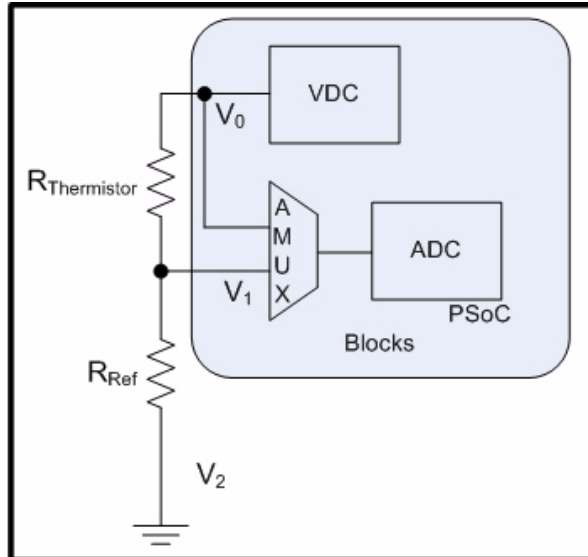

This setup significantly removes gain and offset errors from the resistance calculation.

The analog voltage output from the divider is converted to a digital signal using the ADC on the PSoC. To gain additional accuracy, the voltage at the input side of the divider is also measured. The resistor value is calculated using the ratio of the voltages across the two resistors in the resistor ladder.

$$R_{\text{thermistor}} = R_{\text{ref}} * (V_0 - V_1 / V_1 - V_2); \text{ where } V_2 = 0 \text{ (Ground voltage)}$$

Any offset errors are removed due to subtraction of the two measured voltages. The ratio of these two values removes the measurement path gain error. The error due to the reference resistor is reduced by using a precision resistance in series with the thermistor.

Temperature is calculated using a table of 165 known points on the resistance/temperature curve using a look up table. The table holds resistance values of the thermistor from -40°C to 125°C, in 1°C increments. Linear interpolation is used between the points in the table for temperature calculation up to two places after the decimal.

Temperature is also calculated using the Steinhart-Hart equation. This project currently feeds in the Steinhart-Hart calculated temperature for display.

For more information on using PSoC family devices with a thermistor, refer to Cypress Application Note, [AN2017](#), *Sensing - A Thermistor-Based Thermometer, PSoC Style*.

5.2.3 RTC Crystal and Clocking

The RTC maintains a high precision based on the application of an accurate crystal input used as the clock source. The RTC component inserted by the PSoC Creator provides API calls that can be used to set the time and date and to read the instantaneous current time and date. When the device is in the Show Time sub mode, the code simply loops on CapSense button scans and reads and displays the instantaneous time and date information. The temperature at the board thermistor is sam-

pled and displayed on alternating cycle with the date readings. Therefore, the date and temperature automatically and continuously alternates on the display. The temperature display can be alternated between °C and °F by pressing the "+" or "-".

5.2.4 Contrast Adjustments

To adjust the contrast dynamically, the project calls the adjust bias API call provided by the Segment LCD component. The higher the bias level set in the call to the API the higher the contrast. The API allows a selection between 0 and 127 with 127 corresponding to the maximum contrast level.

Enter a relative value between 0 and 10; the code maps the contrast setting into bias voltage values within the range 47 to 67 (3.23V to 3.78V).

5.2.5 LCD Demonstration

To demonstrate all the segments of LCD glass, the project sequentially demonstrates the various display sections. Refer to [Figure 5-64](#) to know the details of sequence in which various sections of LCD glass are displayed.

5.3 Project Design and Setup

5.3.1 Analog I/O

5.3.1.1 Thermistor Reference Voltage

The thermistor reference voltage analog connection is configured as an input but is actually an output. The VDAC generates a fixed constant output voltage on the analog port. This reference voltage is also sent through the AMUX to be sampled by the Delta-Sigma ADC during temperature calculation periods.

The output is configured for 1-pin width mapping and Hi-Z Analog during Power-On Reset. The port pin is set for High Impedance Analog. The default Built-In settings are used.

Figure 5-4. Thermistor Reference Analog Port Configuration: General Tab

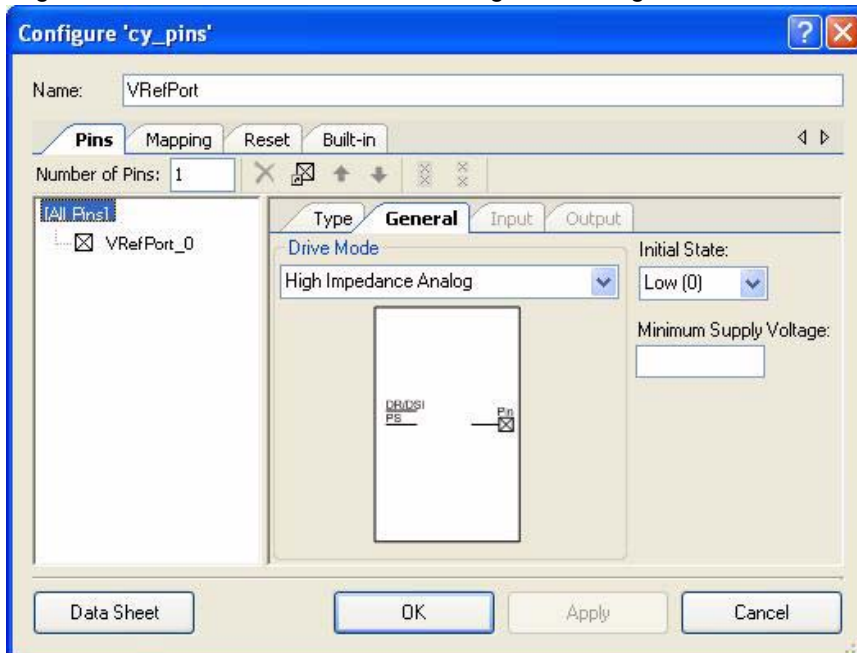
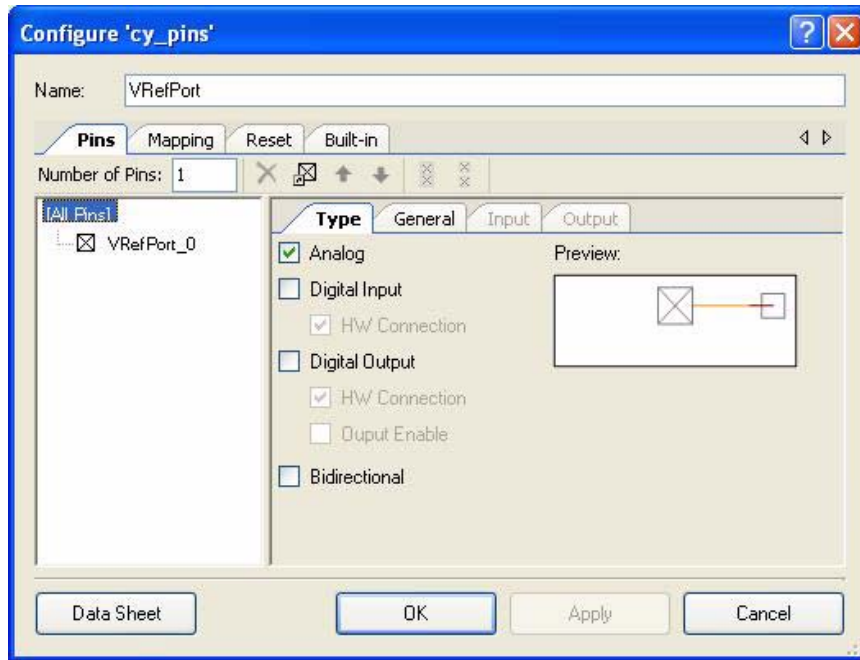

Figure 5-5. Thermistor Reference Analog Port Configuration: Pin Type Tab



5.3.1.2 Thermistor Signal Voltage

The thermistor signal voltage is sampled during temperature calculations. The circuit compares the difference in voltage drop across the thermistor and the fixed resistor. The thermistor signal voltage is sent through the AMUX to be sampled by the Delta-Sigma ADC during temperature calculation. The input is configured for 1-pin width mapping and Hi-Z Analog during Power-On Reset. The port pin is set for High Impedance Analog. The default Built-In settings are used.

Figure 5-6. Thermistor Signal Analog Port Configuration: General Tab

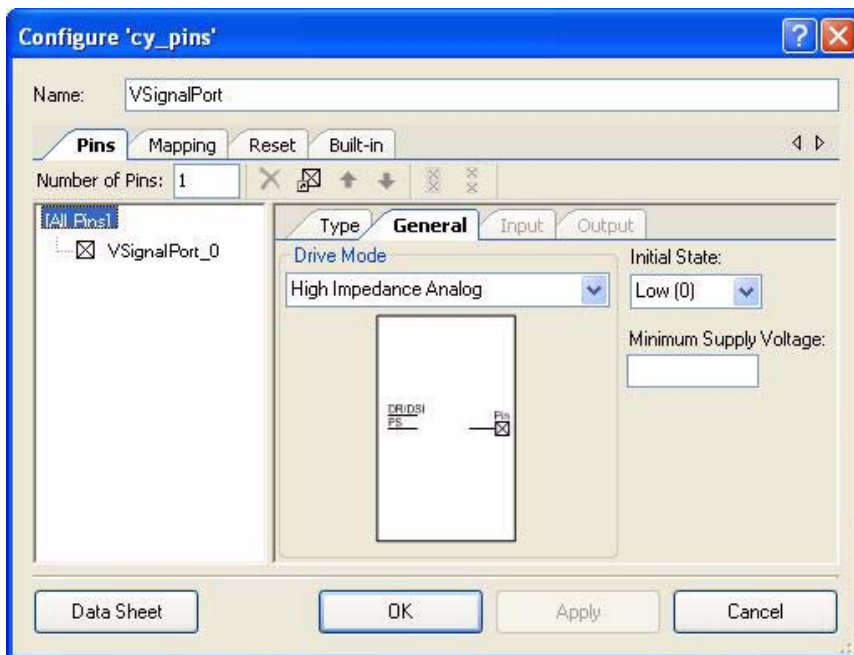
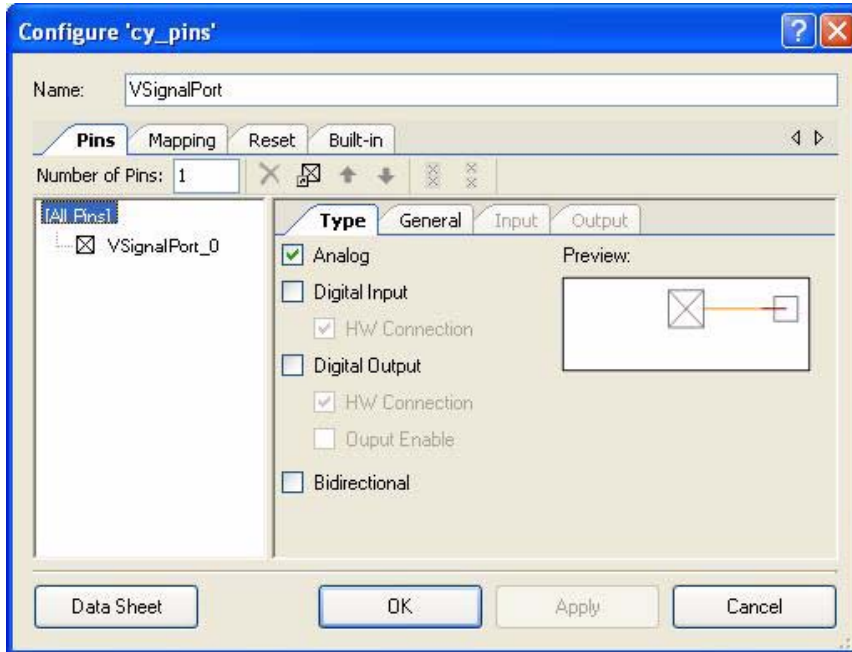

Figure 5-7. Thermistor Signal Analog Port Configuration: Pin Type Tab



5.3.1.3 Accelerometer Y-Axis

The accelerometer Y-axis is measured during rest acceleration and thrown punch periods. The peak measurement during the measured period is retained as the sampled value. The Y-axis signal is sent through the AMUX to be sampled by the Delta-Sigma ADC during acceleration measurement.

The input is configured for 1-pin width mapping and Hi-Z Analog during Power-On Reset. The port pin is set for High Impedance Analog. The default Built-In settings are used.

Figure 5-8. Accelerometer Y-Axis Analog Port Configuration: General Tab

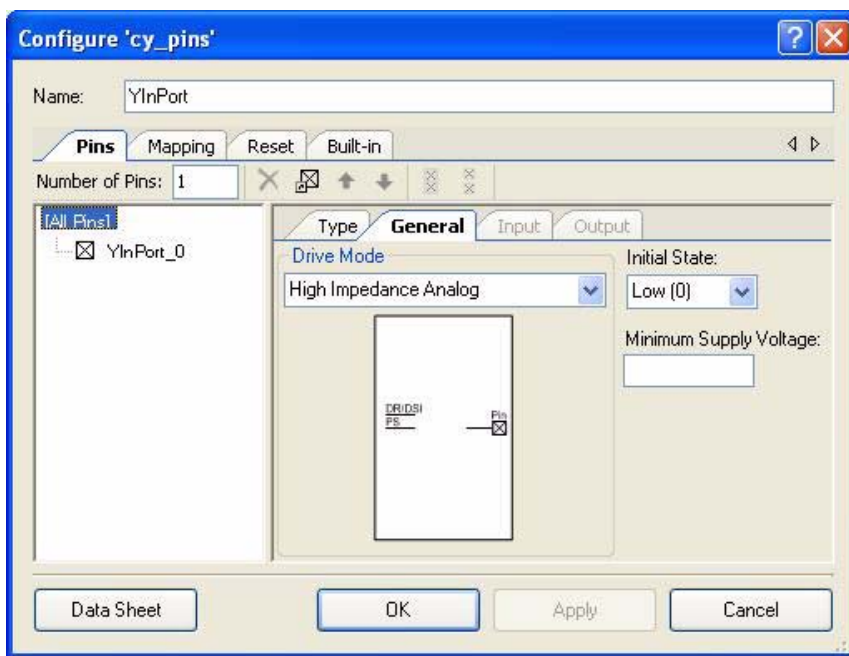
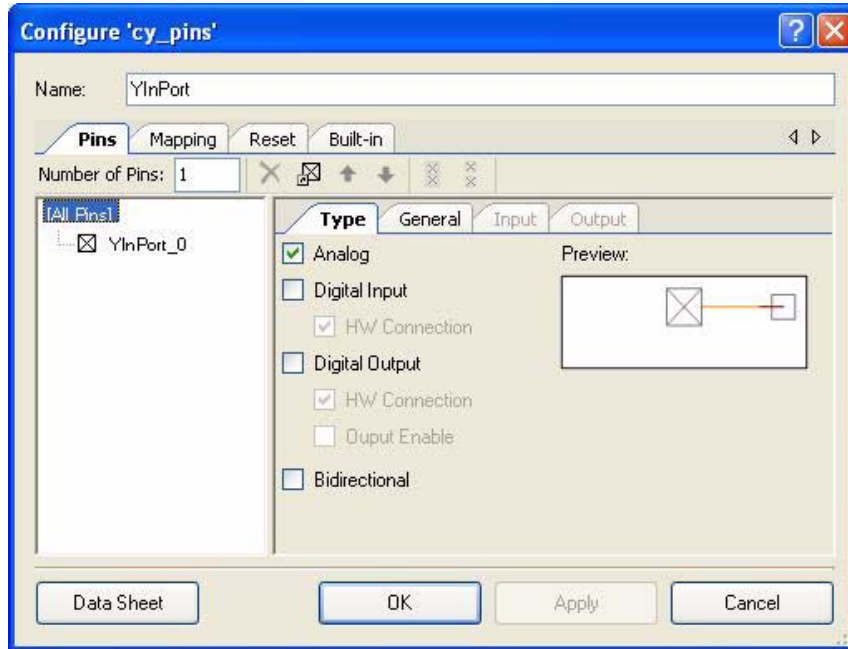

Figure 5-9. Accelerometer Y-Axis Analog Port Configuration: Pin Type Tab



5.3.1.4 Accelerometer X-Axis

The accelerometer X-axis is measured during rest acceleration and thrown punch periods. The peak measurement during the measured period is retained as the sampled value. The X-axis signal is sent through the AMUX to be sampled by the Delta-Sigma ADC during acceleration measurement.

The input is configured for 1-pin width mapping and Hi-Z Analog during Power-On Reset. The port pin is set for High Impedance Analog. The default Built-In settings are used.

Figure 5-10. Accelerometer X-Axis Analog Port Configuration: General Tab

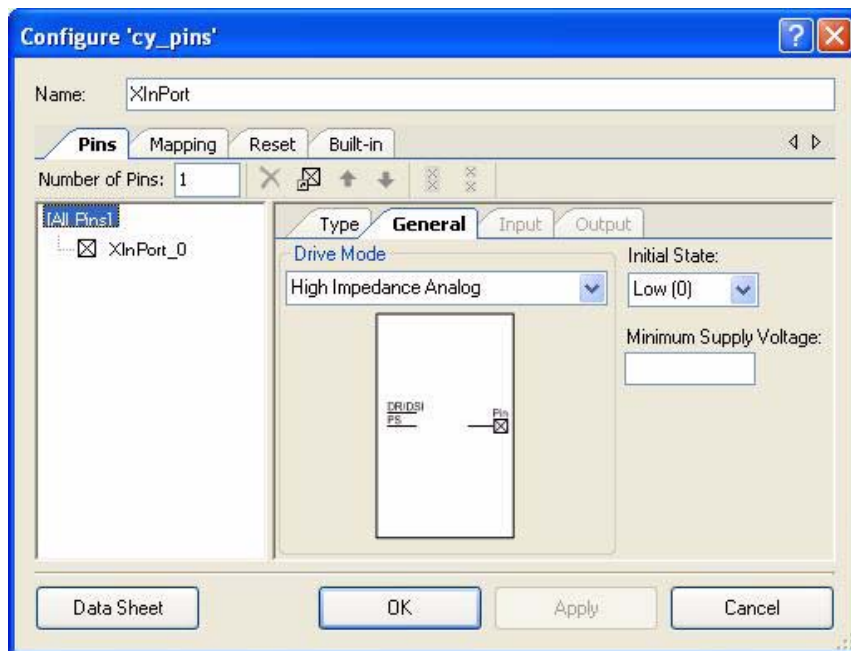
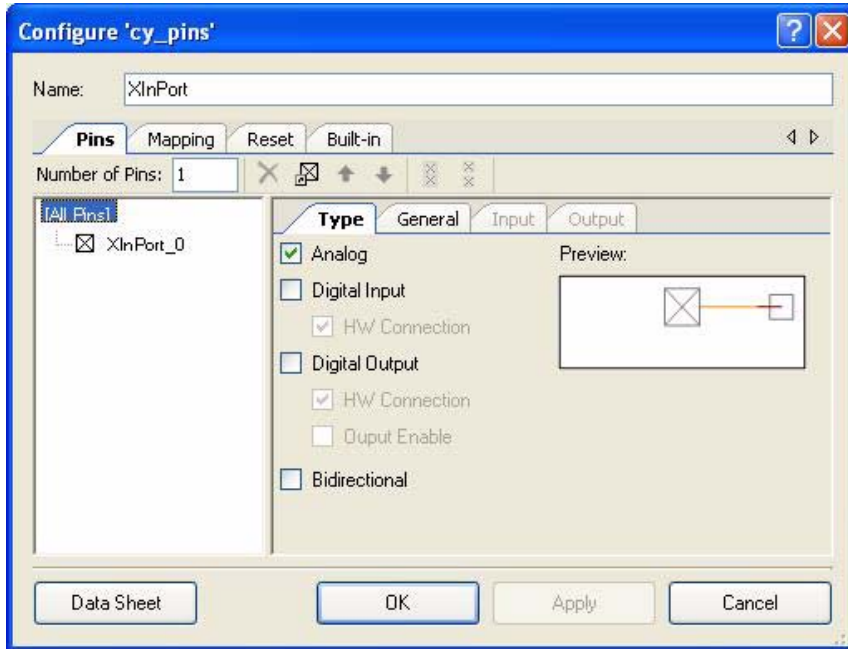

Figure 5-11. Accelerometer X-Axis Analog Port Configuration: Pin Type Tab



5.3.1.5 Battery Monitor - 9V Level

On startup, the project takes a sample measurement of the 9V level. If the level is within a 9V operational range, then the project determines that a 9V battery is connected and enables continuous monitoring of the 9V level. The battery monitor port is measured periodically and the battery icons are updated to reflect the relative charge remaining. The battery monitor signal is sent through the AMUX to be sampled by the Delta-Sigma ADC during sampling periods. The input is configured for 1-pin width mapping and Hi-Z Analog during Power-On Reset. The port pin is set for High Impedance Analog. The default Built-In settings are used.

Figure 5-12. Battery Monitor - 9V Level: General Tab

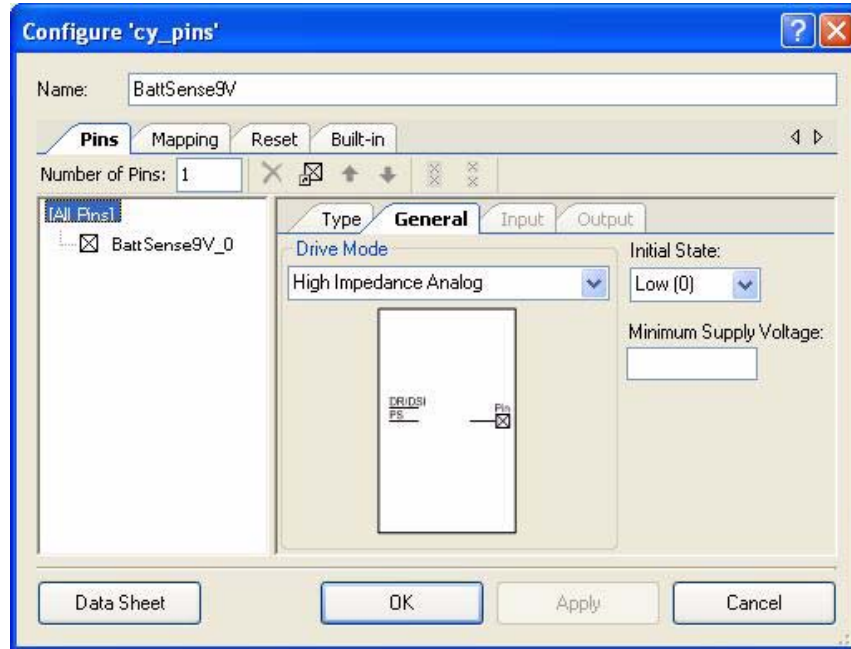
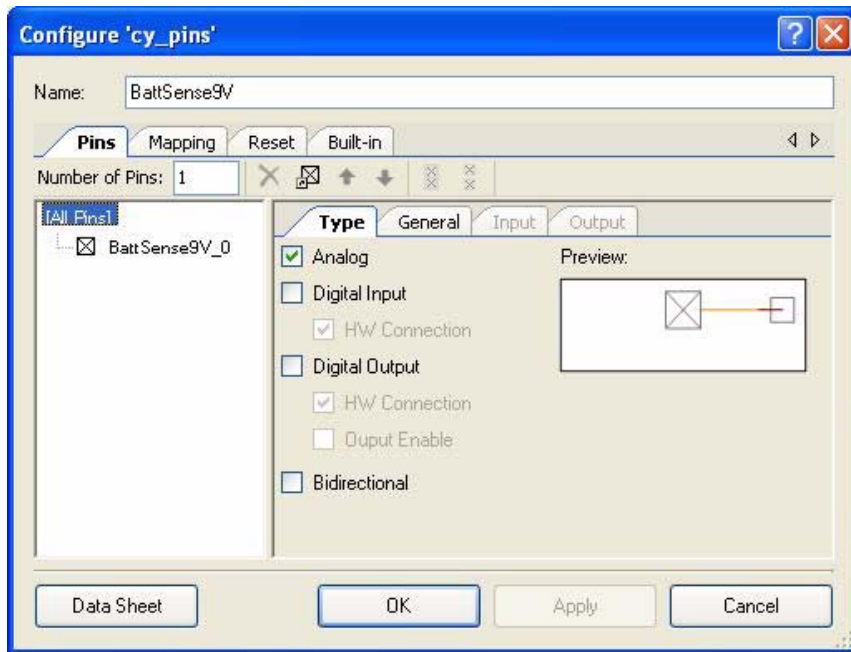

Figure 5-13. Battery Monitor - 9V Level: Pin Type Tab



5.3.2 Analog MUX

The analog mux (AMUX) is configured for 6-inputs. The inputs are the analog input and output signals described earlier. The default Built-In settings are used.

Figure 5-14. Configure Analog MUX: Basic Tab

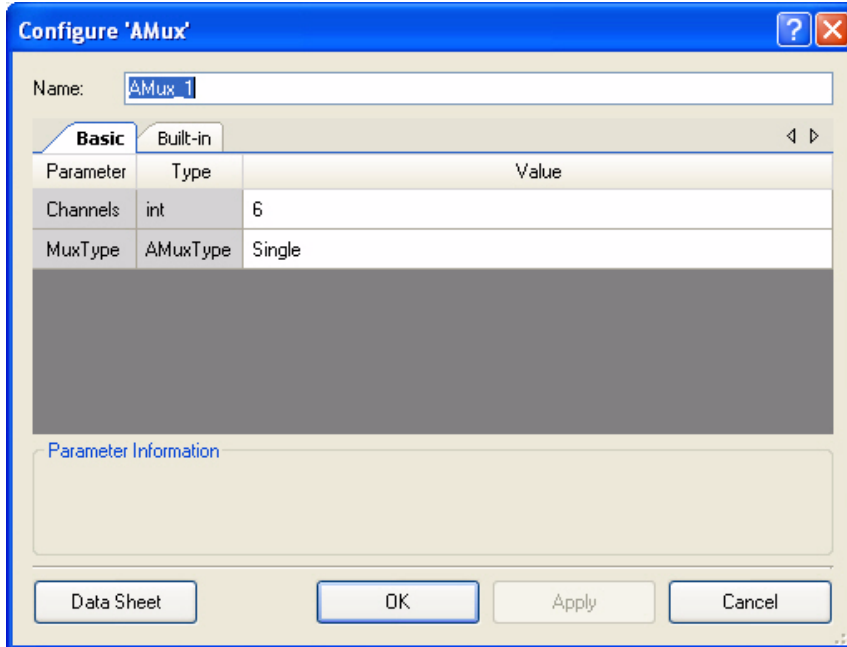

5.3.3 VDAC

The Voltage DAC provides a specific voltage level at the thermistor reference voltage. Low Speed is selected to reduce power requirements. The default Built-In settings are used.

The project code calls the VDAC SetRange API to select the 4V range and the SetValue API to set the output voltage at value=250. This sets the thermistor reference level at just under 4V to allow operation at Vdda as low as 4V. The VDAC is turned off between thermistor measurements to save power.

Figure 5-15. VDAC Configuration: Basic Tab

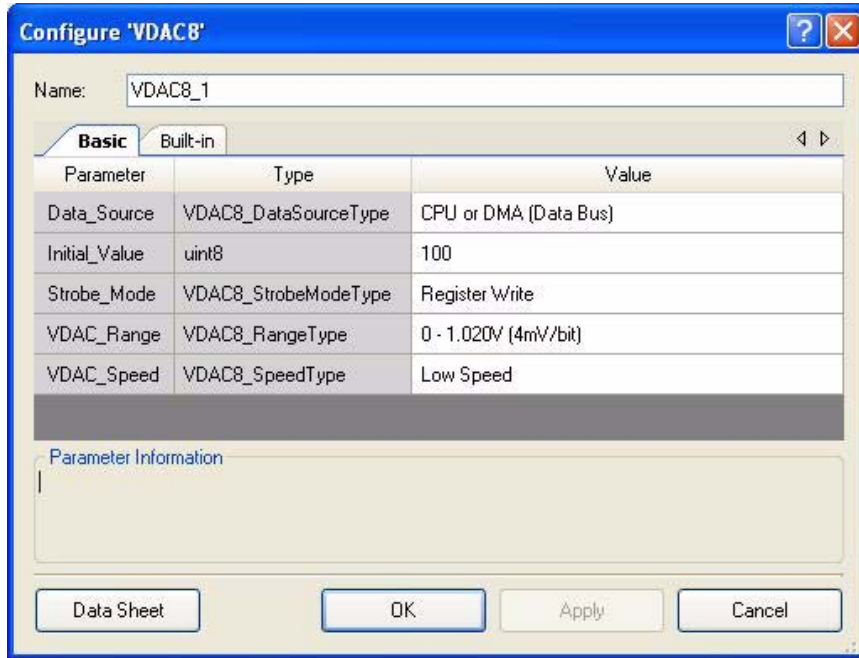

5.3.4 Delta-Sigma ADC

The Delta-Sigma ADC is used to convert the analog signals of the design. The resolution and conversion rate are selected to provide sufficient accuracy and speed for the accelerometer measurements and match the thermistor conversion tables used in this design. The default Built-In settings are used.

Figure 5-16. ADC Configuration

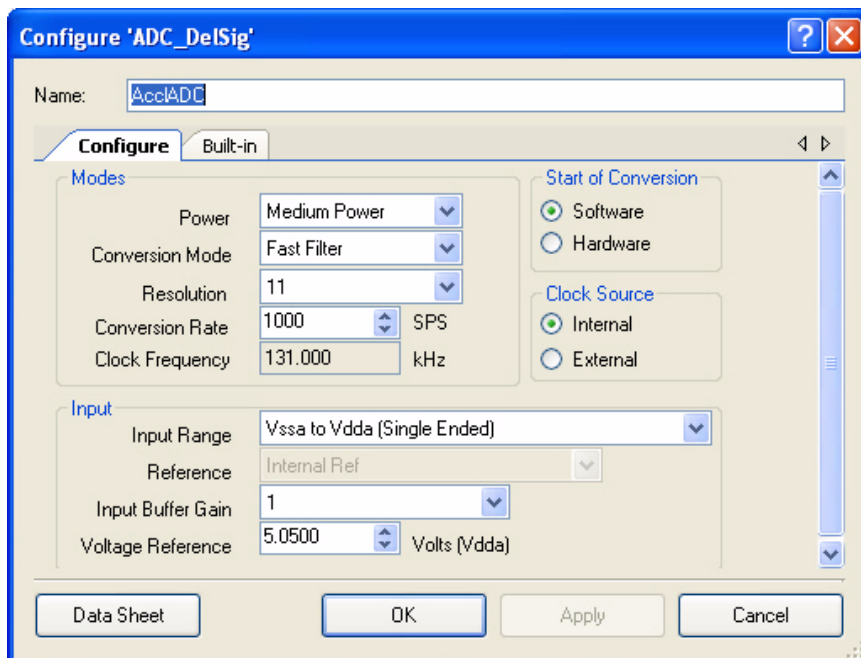

5.3.5 PWM

The PWM provides a signal to the buzzer to create audible alarms and cues. The frequency is selected to match the buzzer used in the design. The design uses a simple 50% duty cycle signal and does not require a high resolution. The default Built-In settings are used.

Figure 5-17. PWM Configuration: Configure Tab

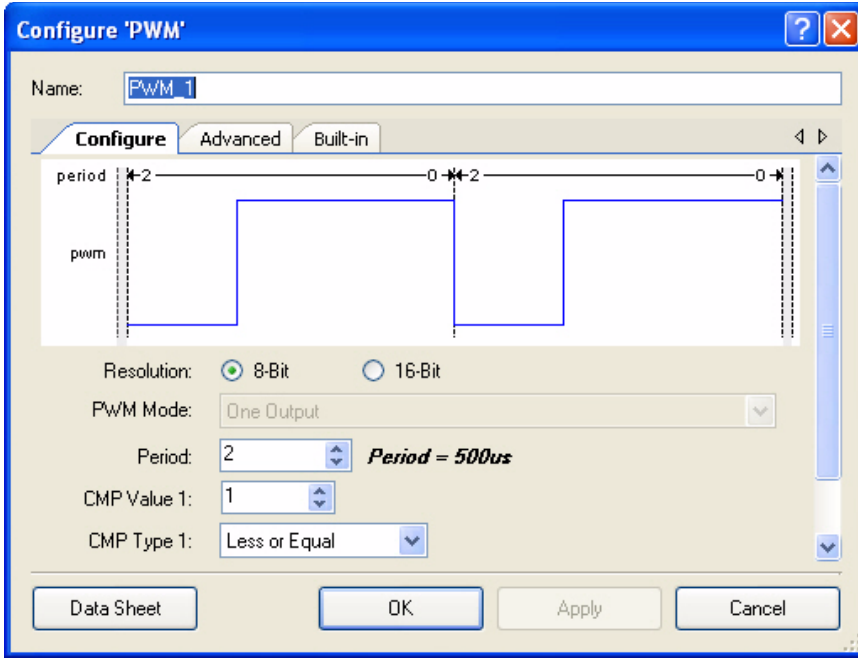
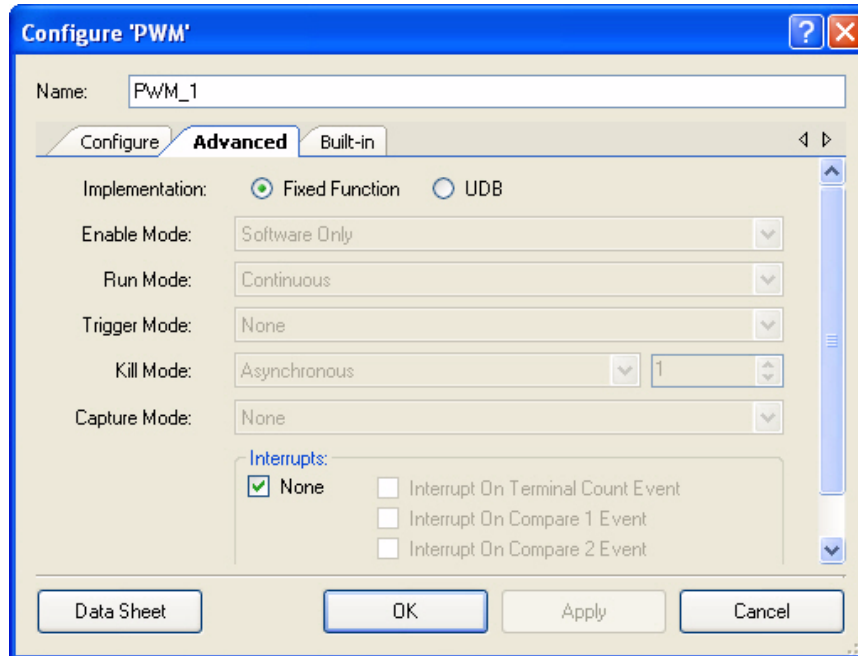

Figure 5-18. PWM Configuration: Advanced Tab



5.3.5.1 PWM 6 kHz Clock Source

The PWM requires a clock source to create the output frequency. The default Built-In settings are used.

Figure 5-19. PWM Clock Source Configuration

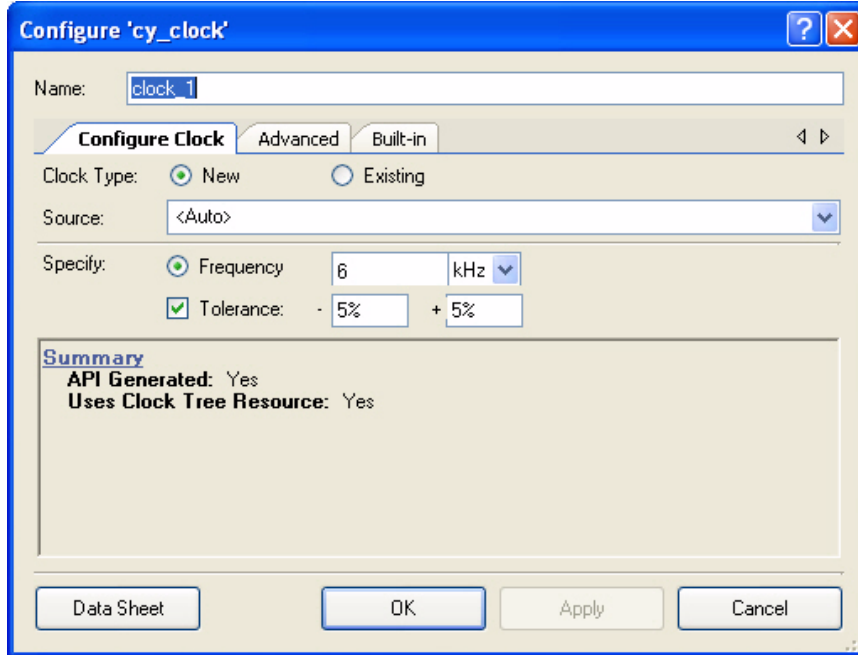
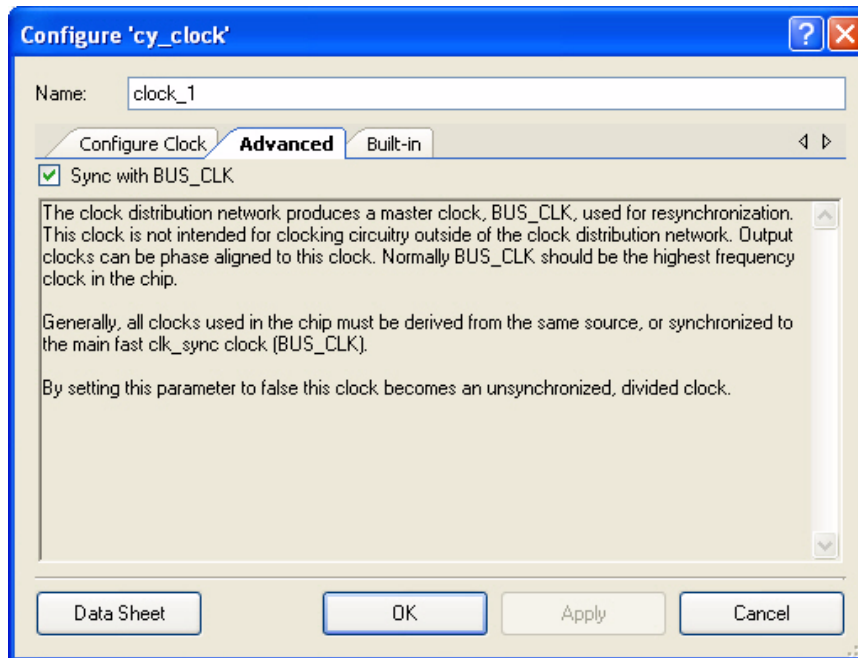

Figure 5-20. PWM Clock Source Configuration: Advanced Tab



5.3.5.2 Logic High for PWM Kill Pin

The PWM Kill signal is not used in this design. The Kill pin is wired high to disable the function.

5.3.5.3 Logic Low for PWM Reset Pin

The PWM component requires a signal on the Reset pin to keep it out of reset after power on reset. The design does not require the application of a Reset signal on the PWM during operation.

5.3.6 Timer

The design requires period timing updates. A single timer component is used with an interrupt service. On interrupt various timer counts are updated including:

- A timeout timer for general purpose failsafe looping.
- An ADC operation timeout timer for ADC get result failsafe looping.
- A clock alarm shutoff timer to automatically stop the alarm ringing after a timeout period.
- An activity timer to automatically signal enter sleep after a period of no button presses.
- A data entry blink timer to provide blinking of characters as they are prompted for entry).

The default Built-In settings are used.

Figure 5-21. Timer Configuration

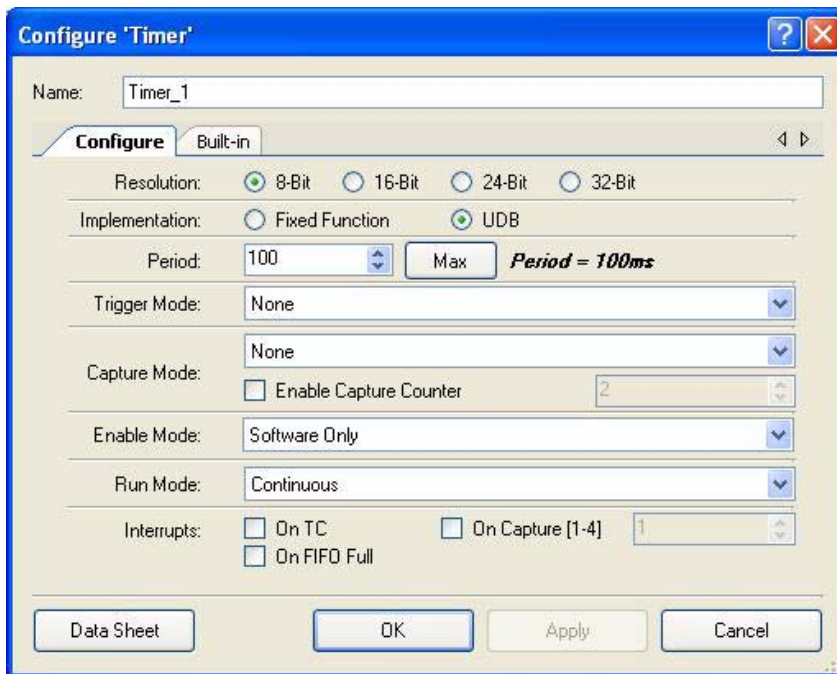

5.3.7 Timer 1 kHz Clock Source

The timer requires a clock source to create the output frequency. The default Built-In settings are used.

Figure 5-22. Timer Clock Source Configuration

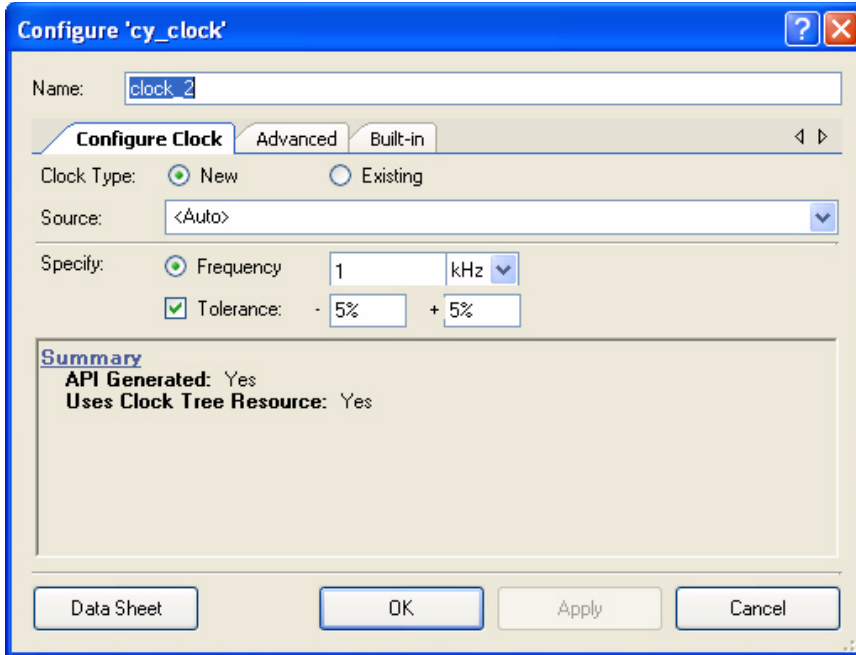
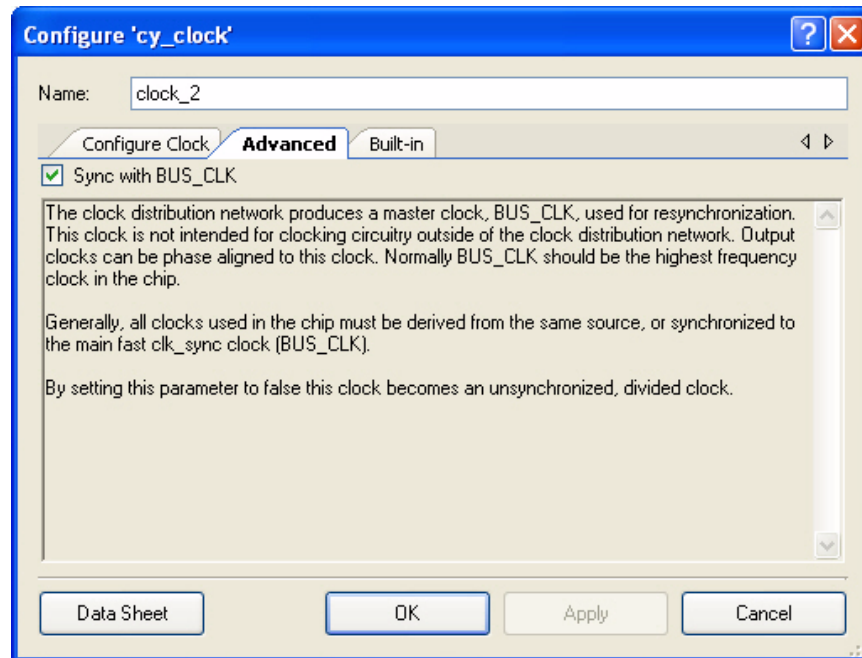

Figure 5-23. Timer Clock Source Configuration: Advanced



5.3.7.1 Logic Level Low for Timer

The timer component requires a signal on the Reset pin to keep it out of reset after power on reset. The design does not require the application of a Reset signal on the timer during operation.

5.3.7.2 Timer ISR

The timer is implemented with the use of a Terminal Count (TC) interrupt. After adding the interrupt to the tc-pin of the timer component, PSoC Creator generates source files for the interrupt service. References to the project code interrupt service routine are added to the generated source. In the generated source file for interrupt handling, there are two places where code must be added by hand. This code is protected by source code generator statements that preserve the user added code on subsequent builds. The code that is added is a prototype for the user provided interrupt service routine and a call to the interrupt service routine (user ISR).

The Timer ISR is set for an interval of once every 100 ms. For a timeout period of 1s, the timer is initialized for a 10 count period.

The actual timer component is initialized at the start of the project. When a timing element is required, a global count variable is added to the timer user ISR code to decrement that count variable. Code is also added for the logic to be executed when the count variable reaches zero.

Figure 5-24. Timer ISR Default Built-In Configuration

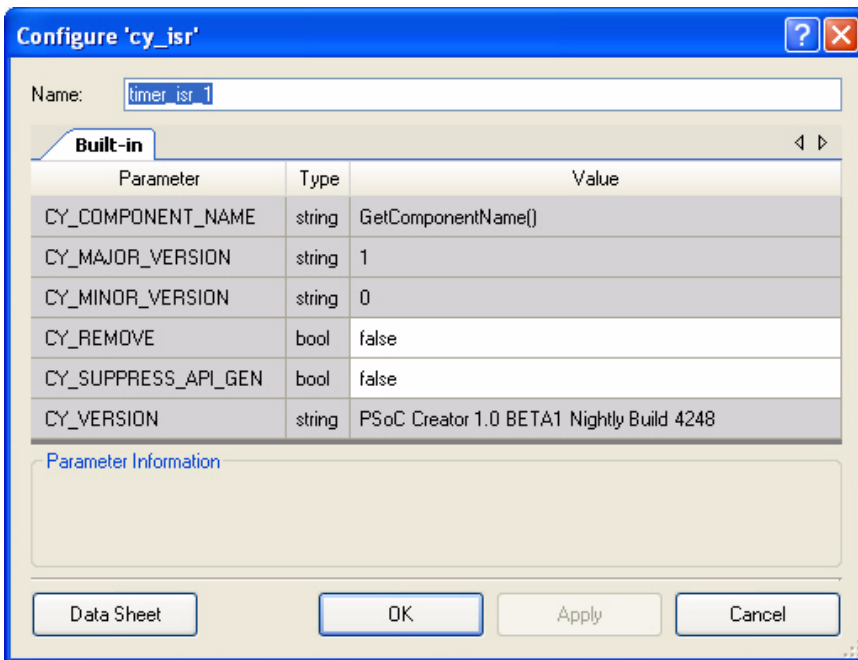

5.3.8 Segment LCD

A single segment LCD component is selected to handle all displays on the LCD glass panel. The component is used to define all segment assignments for the glass. It presents a grid containing an entry for each addressable element in the glass. An element can be a pixel in the matrix characters, a segment of one of the segment displays, or a specific icon built into the display. Each element is considered a pixel and can be individually addressed at its mapped location and can be turned on or off using the component pixel handling API calls.

There are also helper functions that can be defined. Each helper is specifically designed to allow handling of the different types of characters in the display. Thus, segments of a segment character can be grouped and addressed collectively by a single helper. Each helper has a set of component API calls that you can place in the code for writing digits or characters to the target display areas.

Each icon is turned on or off using a write pixel API call. The matrix display characters are set using a write string API call. The segment displays are written one character at a time using a write character or write digit API call. For demonstration purposes, the large and small 7-segment characters are also written using a write number API call which writes the hex or decimal value to the entire set of large or small 7-segment characters.

In the basic configuration, the bias voltage is selected. To adjust the contrast dynamically, the project calls the adjust bias API call provided by the segment LCD component. The higher the bias level set in the call to the API the higher the contrast. The API allows a selection between 0 and 127 with 127 corresponding to the maximum contrast level (see [CONTRAST on page 14](#)). The frame rate is selected to be the maximum rate before the characters in the display begin to reduce in contrast. The Hi Drive Time is set to the maximum drive time for the Type B waveform that is selected.

The glass is of type FSTN with a 6 o'clock viewing angle. The drive method is 1/16 Duty, 1/5 Bias. The operating voltage is 3.3V. The polarizer mode is Reflective/Positive.

Figure 5-25. Segment LCD Configuration: Basic Tab

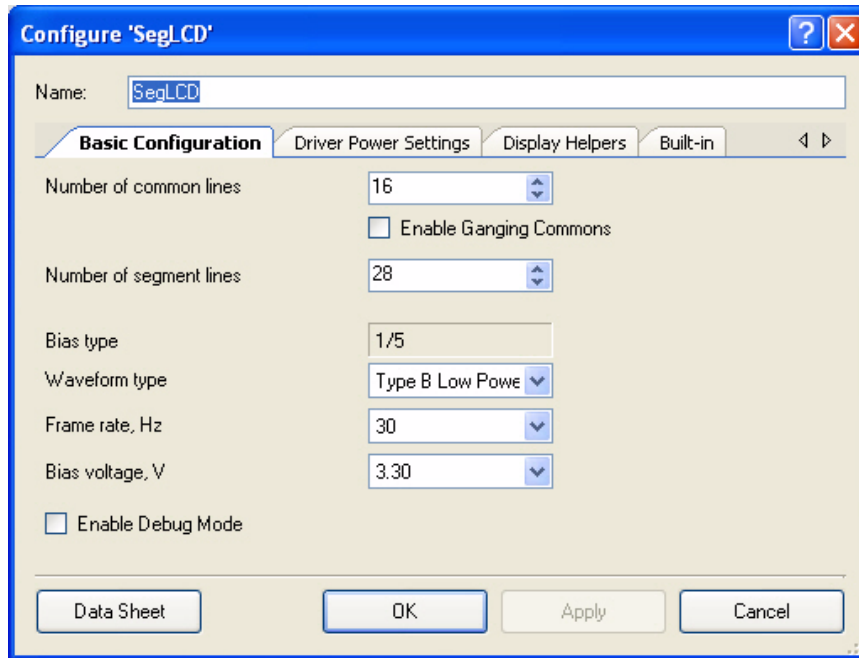
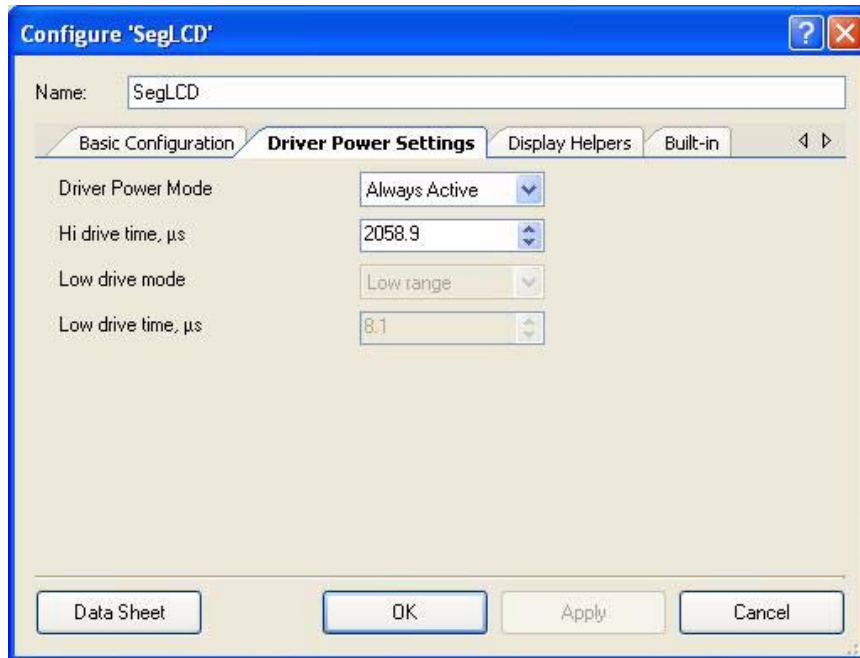

Figure 5-26. Segment LCD Configuration: Driver Power Settings



5.3.8.1 LCD Glass Character Pixel Mapping

Refer to the component data sheet for details on mapping helper functions. Note that it is helpful to map groups of icons into single helpers to address each member of the group sequentially with the helper API calls.

In the following pixel mapping dialog, the overall mapping of all of the pixels into helper groups is shown. These mappings are used in the project design to define helpers for the matrix characters, the large 7-segment characters, the small 7-segment characters, the signal strength icons, the progress bar icons, and miscellaneous icon groupings.

Note that the matrix pixels are mapped with the HDOTX_YZ names where: X is the character number (0 to 7 with character 0 at the left of the helper area), Y is the character matrix row position, and Z is the character matrix column position. The helper allows each pixel to be mapped by clicking and dragging each pixel block in the helper area to a single segment position in the grid. The helper tool allows you to configure the number of characters in a matrix or segment character display.

The 7-segment character segments are shown in the map with the H7SEGX_A names where X is the character position in the group and A is the Alpha name of the segment within the character. The small 7-segment helper maps are shown in a group of 4-character helpers and the large 7-segment helper maps are shown in a group of 5-character helpers. The 16-segment character is mapped with the H16SEG0... symbols and the 14-character is mapped with the H14SEG0... symbols.

Figure 5-27. Pixel Mapping Dialog: Matrix Helper

Pixel Mapping Table

	Com15	Com14	Com13	Com12	Com11	Com10	Com9	Com8	Com7	Com6	Com5	Com4	Com3	Com2	Com1	Com0
Seg0	HD0T7_47	HD0T7_48	HD0T7_45	HD0T7_44	HD0T7_43	HD0T7_42	HD0T7_41	HD0T7_40	HD0T0_07	HD0T0_08	HD0T0_05	HD0T0_04	HD0T0_03	HD0T0_02	HD0T0_01	HD0T0_00
Seg1	HD0T7_37	HD0T7_36	HD0T7_35	HD0T7_34	HD0T7_33	HD0T7_32	HD0T7_31	HD0T7_30	HD0T0_17	HD0T0_16	HD0T0_15	HD0T0_14	HD0T0_13	HD0T0_12	HD0T0_11	HD0T0_10
Seg2	HD0T7_27	HD0T7_26	HD0T7_25	HD0T7_24	HD0T7_23	HD0T7_22	HD0T7_21	HD0T7_20	HD0T0_27	HD0T0_26	HD0T0_25	HD0T0_24	HD0T0_23	HD0T0_22	HD0T0_21	HD0T0_20
Seg3	HD0T7_17	HD0T7_16	HD0T7_15	HD0T7_14	HD0T7_13	HD0T7_12	HD0T7_11	HD0T7_10	HD0T0_37	HD0T0_36	HD0T0_35	HD0T0_34	HD0T0_33	HD0T0_32	HD0T0_31	HD0T0_30
Seg4	HD0T7_07	HD0T7_06	HD0T7_05	HD0T7_04	HD0T7_03	HD0T7_02	HD0T7_01	HD0T7_00	HD0T0_47	HD0T0_46	HD0T0_45	HD0T0_44	HD0T0_43	HD0T0_42	HD0T0_41	HD0T0_40
Seg5	HD0T6_47	HD0T6_46	HD0T6_45	HD0T6_44	HD0T6_43	HD0T6_42	HD0T6_41	HD0T6_40	HD0T1_07	HD0T1_06	HD0T1_05	HD0T1_04	HD0T1_03	HD0T1_02	HD0T1_01	HD0T1_00
Seg6	HD0T6_37	HD0T6_36	HD0T6_35	HD0T6_34	HD0T6_33	HD0T6_32	HD0T6_31	HD0T6_30	HD0T1_17	HD0T1_16	HD0T1_15	HD0T1_14	HD0T1_13	HD0T1_12	HD0T1_11	HD0T1_10
Seg7	HD0T6_27	HD0T6_26	HD0T6_25	HD0T6_24	HD0T6_23	HD0T6_22	HD0T6_21	HD0T6_20	HD0T1_27	HD0T1_26	HD0T1_25	HD0T1_24	HD0T1_23	HD0T1_22	HD0T1_21	HD0T1_20
Seg8	HD0T6_17	HD0T6_16	HD0T6_15	HD0T6_14	HD0T6_13	HD0T6_12	HD0T6_11	HD0T6_10	HD0T1_37	HD0T1_36	HD0T1_35	HD0T1_34	HD0T1_33	HD0T1_32	HD0T1_31	HD0T1_30
Seg9	HD0T6_07	HD0T6_06	HD0T6_05	HD0T6_04	HD0T6_03	HD0T6_02	HD0T6_01	HD0T6_00	HD0T1_47	HD0T1_46	HD0T1_45	HD0T1_44	HD0T1_43	HD0T1_42	HD0T1_41	HD0T1_40
Seg10	HD0T5_47	HD0T5_46	HD0T5_45	HD0T5_44	HD0T5_43	HD0T5_42	HD0T5_41	HD0T5_40	HD0T2_07	HD0T2_06	HD0T2_05	HD0T2_04	HD0T2_03	HD0T2_02	HD0T2_01	HD0T2_00
Seg11	HD0T5_37	HD0T5_36	HD0T5_35	HD0T5_34	HD0T5_33	HD0T5_32	HD0T5_31	HD0T5_30	HD0T2_17	HD0T2_16	HD0T2_15	HD0T2_14	HD0T2_13	HD0T2_12	HD0T2_11	HD0T2_10
Seg12	HD0T5_27	HD0T5_26	HD0T5_25	HD0T5_24	HD0T5_23	HD0T5_22	HD0T5_21	HD0T5_20	HD0T2_27	HD0T2_26	HD0T2_25	HD0T2_24	HD0T2_23	HD0T2_22	HD0T2_21	HD0T2_20
Seg13	HD0T5_17	HD0T5_16	HD0T5_15	HD0T5_14	HD0T5_13	HD0T5_12	HD0T5_11	HD0T5_10	HD0T2_37	HD0T2_36	HD0T2_35	HD0T2_34	HD0T2_33	HD0T2_32	HD0T2_31	HD0T2_30
Seg14	HD0T5_07	HD0T5_06	HD0T5_05	HD0T5_04	HD0T5_03	HD0T5_02	HD0T5_01	HD0T5_00	HD0T2_47	HD0T2_46	HD0T2_45	HD0T2_44	HD0T2_43	HD0T2_42	HD0T2_41	HD0T2_40
Seg15	HD0T4_47	HD0T4_46	HD0T4_45	HD0T4_44	HD0T4_43	HD0T4_42	HD0T4_41	HD0T4_40	HD0T3_07	HD0T3_06	HD0T3_05	HD0T3_04	HD0T3_03	HD0T3_02	HD0T3_01	HD0T3_00
Seg16	HD0T4_37	HD0T4_36	HD0T4_35	HD0T4_34	HD0T4_33	HD0T4_32	HD0T4_31	HD0T4_30	HD0T3_17	HD0T3_16	HD0T3_15	HD0T3_14	HD0T3_13	HD0T3_12	HD0T3_11	HD0T3_10
Seg17	HD0T4_27	HD0T4_26	HD0T4_25	HD0T4_24	HD0T4_23	HD0T4_22	HD0T4_21	HD0T4_20	HD0T3_27	HD0T3_26	HD0T3_25	HD0T3_24	HD0T3_23	HD0T3_22	HD0T3_21	HD0T3_20
Seg18	HD0T4_17	HD0T4_16	HD0T4_15	HD0T4_14	HD0T4_13	HD0T4_12	HD0T4_11	HD0T4_10	HD0T3_37	HD0T3_36	HD0T3_35	HD0T3_34	HD0T3_33	HD0T3_32	HD0T3_31	HD0T3_30
Seg19	HD0T4_07	HD0T4_06	HD0T4_05	HD0T4_04	HD0T4_03	HD0T4_02	HD0T4_01	HD0T4_00	HD0T3_47	HD0T3_46	HD0T3_45	HD0T3_44	HD0T3_43	HD0T3_42	HD0T3_41	HD0T3_40
Seg20	H14SEG0_0	H14SEG0_1	H14SEG0_2	H14SEG0_3	H14SEG0_4	H14SEG0_5	H14SEG0_6	PM	H16SEG0_0	H16SEG0_1	H16SEG0_2	H16SEG0_3	H16SEG0_4	H16SEG0_5	H16SEG0_6	H16SEG0_7
Seg21	H14SEG0_8	H14SEG0_9	H14SEG0_10	H14SEG0_11	H14SEG0_12	H14SEG0_13	H14SEG0_14	T9	H16SEG0_8	H16SEG0_9	H16SEG0_10	H16SEG0_11	H16SEG0_12	H16SEG0_13	H16SEG0_14	H16SEG0_15
Seg22	T4	T3	T2	T1	Z4	MAX	Z6	Z1	Q2	Q1	P10	P9	P8	P7	P6	P1
Seg23	Q3	Q4	Q5	Q6	Q7	Q8	Q9	Q10	T8	H7SEG4_0	H7SEG4_1	H7SEG4_2	H7SEG4_3	H7SEG4_4	H7SEG4_5	H7SEG4_6
Seg24	AM	H7SEG8_D	H7SEG8_C	H7SEG8_E	H7SEG8_G	H7SEG8_B	H7SEG8_F	H7SEG8_A	T7	H7SEG3_0	H7SEG3_1	H7SEG3_2	H7SEG3_3	H7SEG3_4	H7SEG3_5	H7SEG3_6
Seg25	Z5	H7SEG7_D	H7SEG7_C	H7SEG7_E	H7SEG7_G	H7SEG7_B	H7SEG7_F	H7SEG7_A	COL	H7SEG2_0	H7SEG2_1	H7SEG2_2	H7SEG2_3	H7SEG2_4	H7SEG2_5	H7SEG2_6
Seg26	Z3	H7SEG6_D	H7SEG6_C	H7SEG6_E	H7SEG6_G	H7SEG6_B	H7SEG6_F	H7SEG6_A	T8	H7SEG1_0	H7SEG1_1	H7SEG1_2	H7SEG1_3	H7SEG1_4	H7SEG1_5	H7SEG1_6
Seg27	Z2	H7SEG5_D	H7SEG5_C	H7SEG5_E	H7SEG5_G	H7SEG5_B	H7SEG5_F	H7SEG5_A	T5	H7SEG0_0	H7SEG0_1	H7SEG0_2	H7SEG0_3	H7SEG0_4	H7SEG0_5	H7SEG0_6

Figure 5-28. Five Character Helper for Large Seven Segment Display

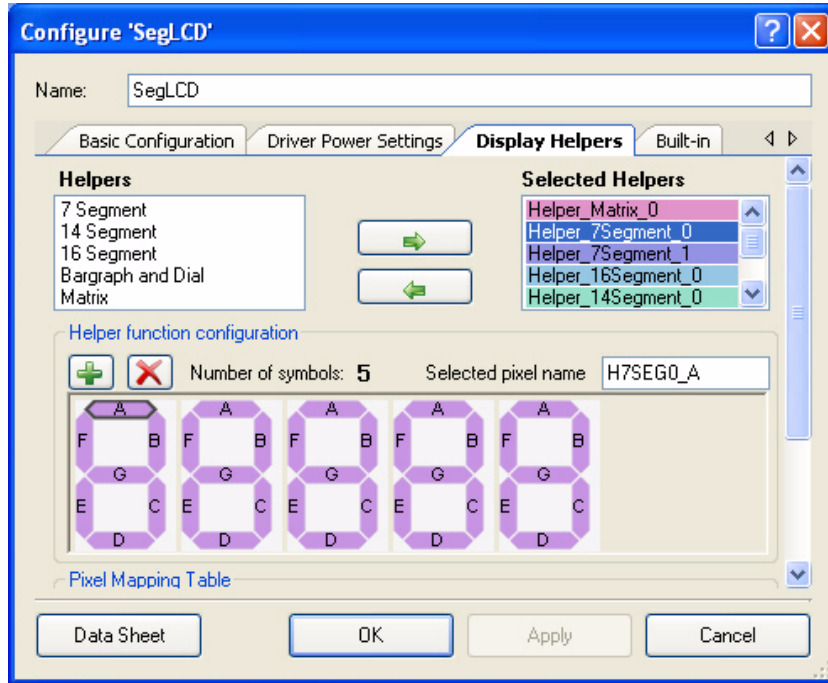

Figure 5-29. Four Character Helper for Small Seven Segment Display

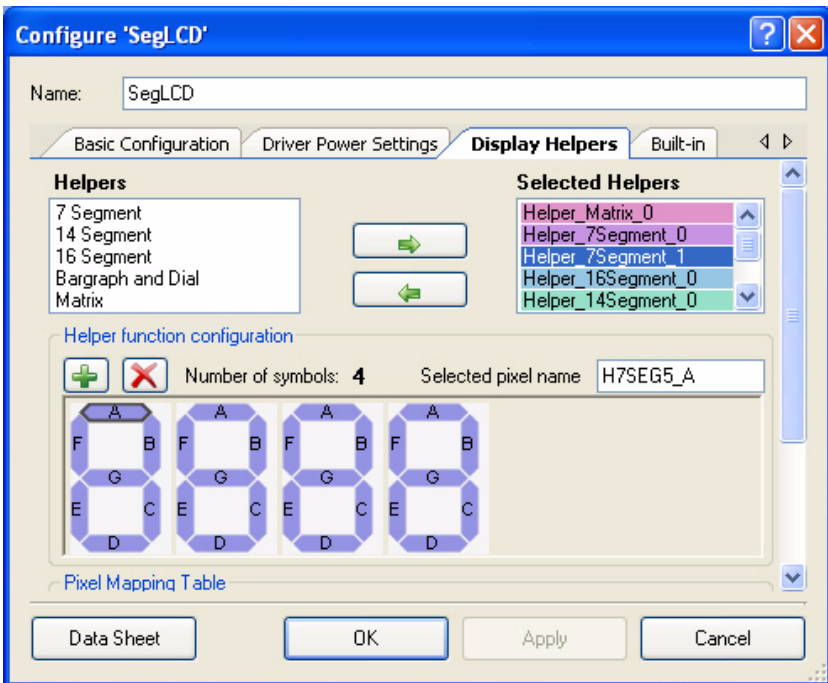

Figure 5-30. One Character Helper for 16-Segment Display

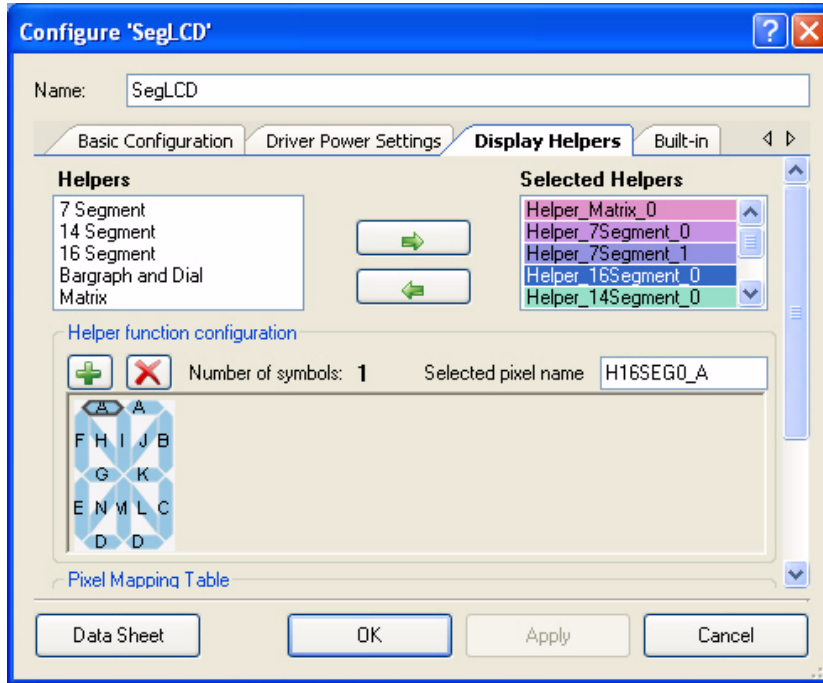
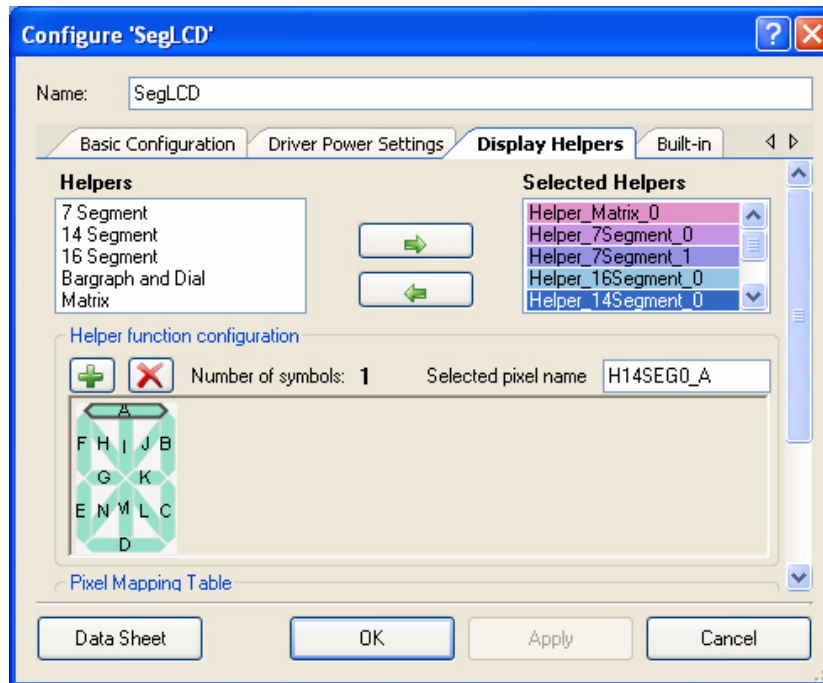

Figure 5-31. One Character Helper for 14-Segment Display



5.3.8.2 LCD Glass Icon Pixel Mapping

Refer to the hardware design document included in this package for the glass segment icon mapping and symbol names (*LCD Layout s93043-602.pdf*, page 2). Icons can be grouped together for ease of control, such as signal strength, progress, and battery level bars or they can be individually controlled by direct pixel access.

The icon bar graph helpers allow to specify the number of icon elements in the bar. This information is used by the helper to provide the bar element pixel segment selection and allows you to specify the element position in the graph in the parameters in the API calls for the bar graph.

Figure 5-32. Bar Graph Helper for 10-Element Progress Bar Icons

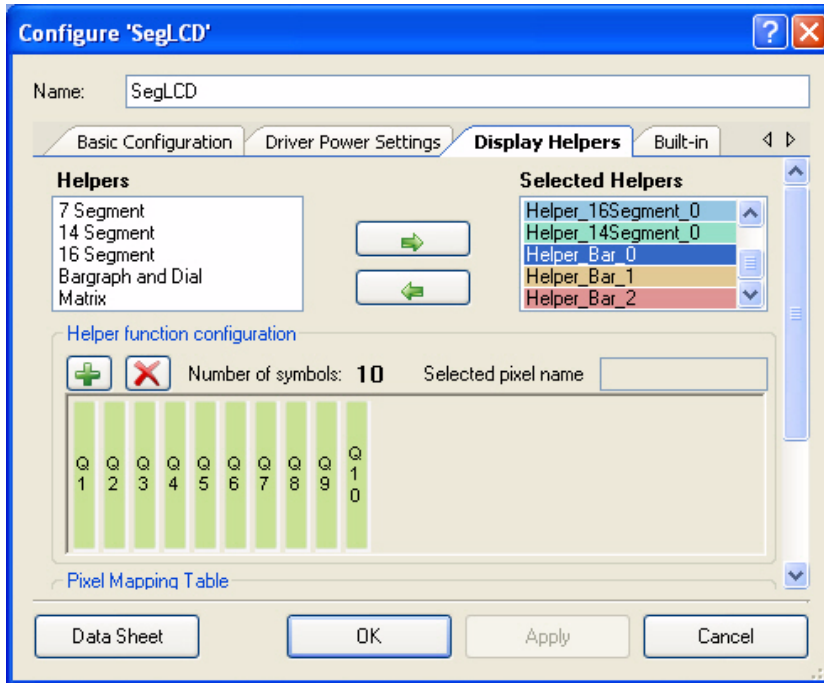

Figure 5-33. Bar Graph Helper for Four Elements Signal Strength Icons (include ZZZ and CyLogo)

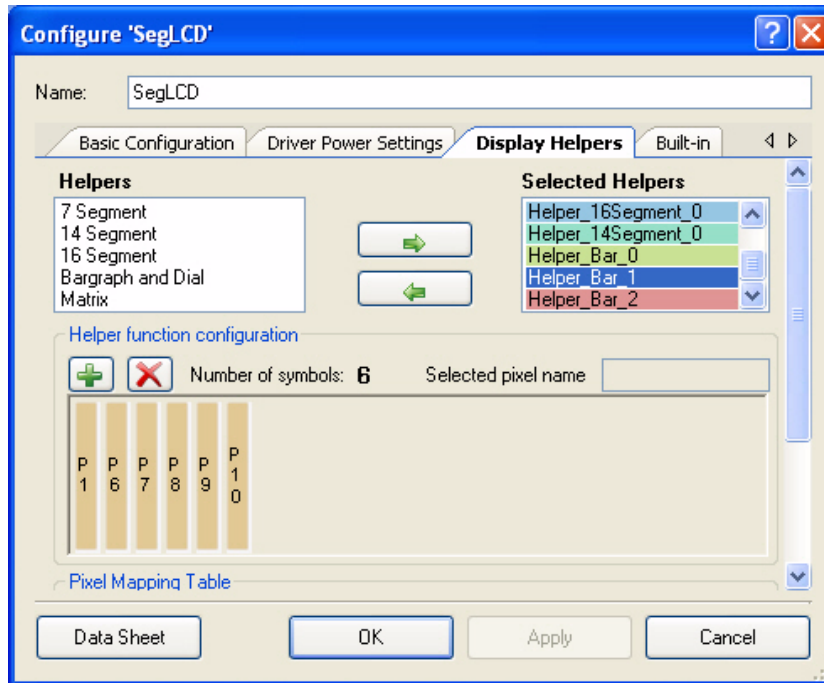
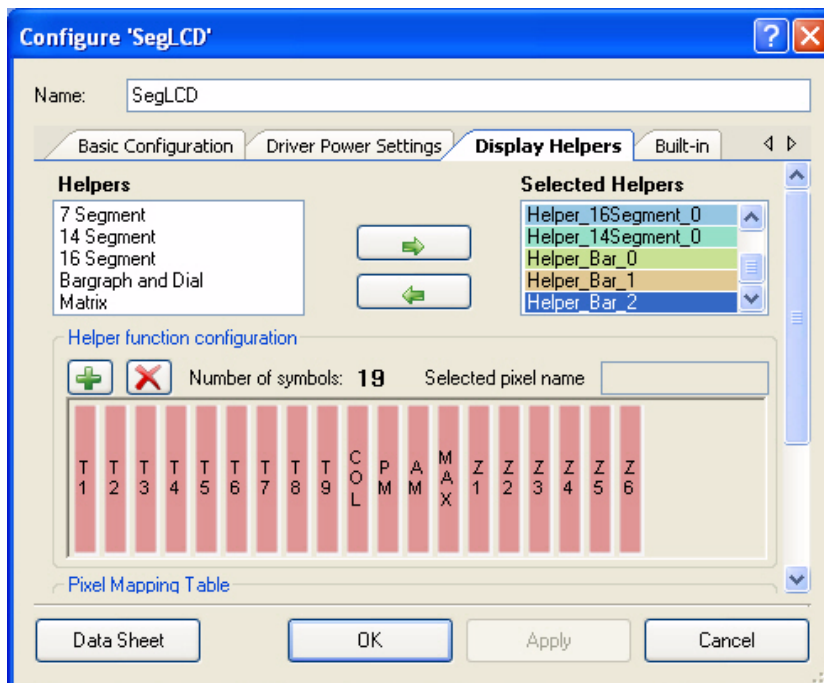

Figure 5-34. Bar Graph Helper for Four Element Battery Level Icons



It includes remaining icon pixels: four large decimal points, large colon, slash, bell, MAX, AM, PM, small decimal points, and small colon).

5.3.8.3 *Pixel Only Mapped Icons*

The following icons are only mapped for use as direct pixels:

- BELL (Z6)
- MAX (MAX)
- AM (AM)
- PM (PM)
- Small '1' Icon (Z1)
- Small decimal point 1 (Z2)
- Small decimal point 2 (Z3)
- Small decimal point 3 (Z5)
- Small colon (Z4)

These icons can be turned on and off directly by using the pixel writing API calls.

5.3.9 Digital I/O

5.3.9.1 *Sleep Button*

The sleep button is configured to generate an interrupt on both edges of a button press. The default Built-In settings are used.

If the project is in wake mode, when the button is pressed and released, the button ISR signals a go to sleep command.

If the project is in sleep mode, when the button is pressed, a wake signal is sent and the code returns to normal flow just after the sleep entry point.

Note In sleep mode, the PSoC 3 device does not go into sleep; the firmware is just put in a lower power mode. In the low power mode, only RTC component is left running and all other components are powered off. It periodically wakes up the PSoC enough to strobe the ZZZ icon on and off to indicate that the device is in low power mode. To know details on low power operation mode refer to [Low Power Entry on page 64](#).

When the project is powered from a wall supply and the operator is in the RTC/TEMP submenu, then the sleep entry is blocked. If the project is battery powered, there is no sleep blocking.

Figure 5-35. Sleep Button Configuration: General Tab

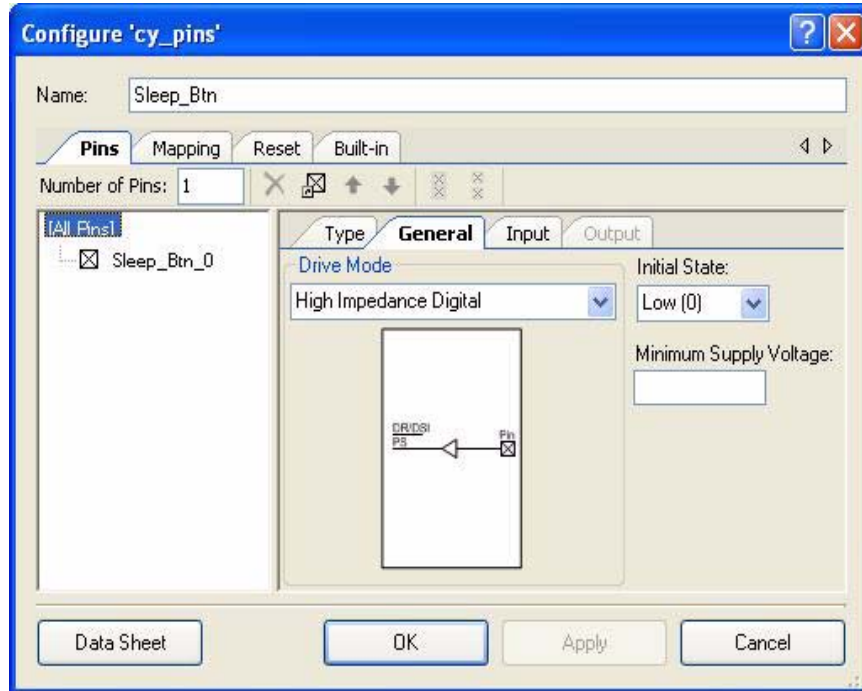

Figure 5-36. Sleep Button Configuration: Pin Type Tab (includes dual-edge interrupt configuration)

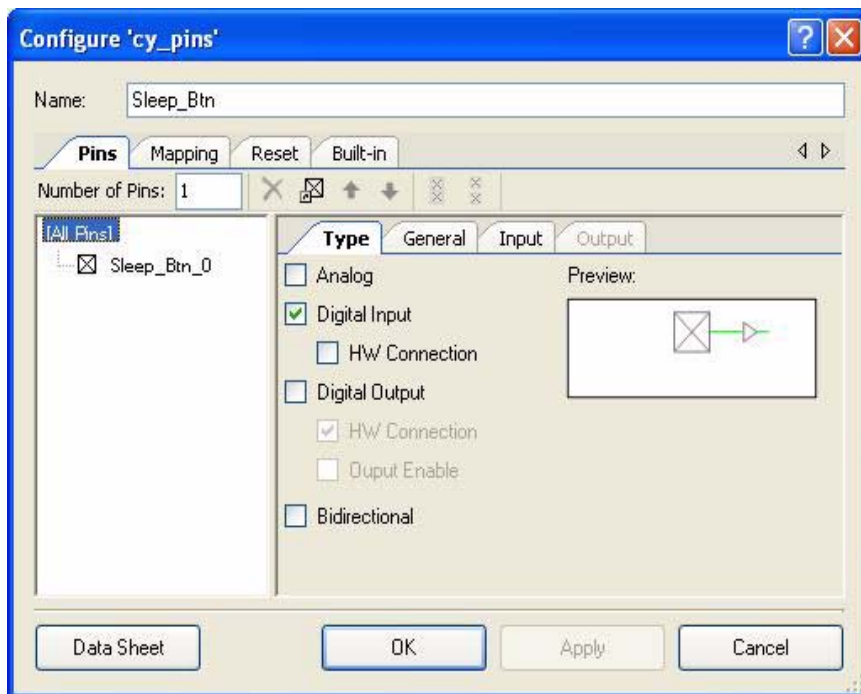
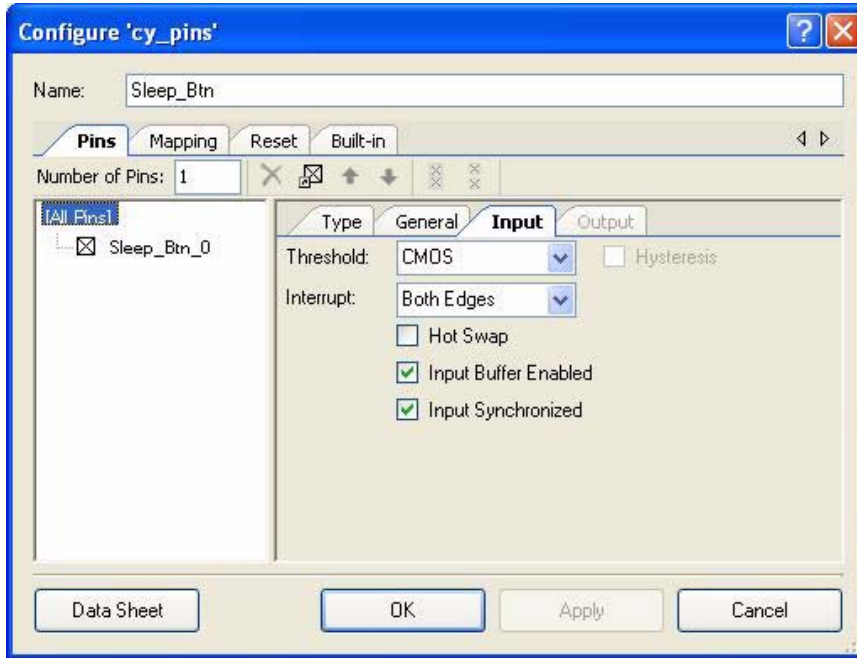

Figure 5-37. Sleep Button Configuration: Input Tab (includes dual edge interrupt configuration)



5.3.9.2 Sleep Button ISR

The PSoC Creator generates source files for the Sleep Button ISR. The project Sleep Button code includes project specific code for interrupt handling. References to the project Sleep Button code interrupt service routine are added to the generated source. In the generated source file for the interrupt handling, there are two places where code must be added manually. This code is protected by source code generator statements that preserve the user entered code during subsequent builds. The code added is a prototype for the user provided ISR and a call to the user ISR in the generated source.

Figure 5-38. Sleep Button ISR

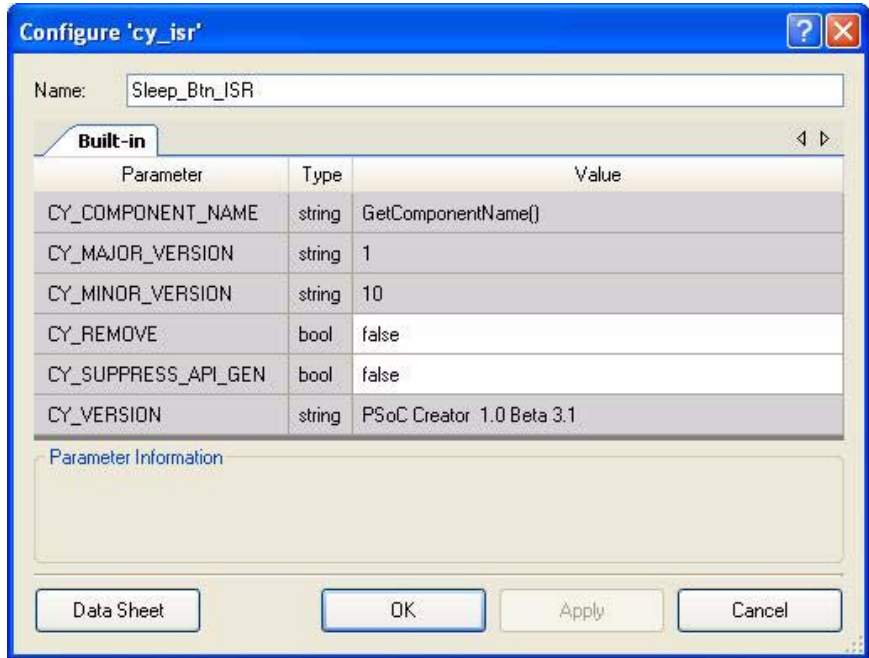

5.3.9.3 Wall Supply (Vin) Detect

The Wall Supply (Vin) Detect is configured to allow firmware to poll the port with the Read API call. This signal is used in conjunction with the battery sense pins to communicate the current power configuration to the project. The default Built-In settings are used.

Figure 5-39. Wall Supply (Vin) Detect Configuration: General Tab

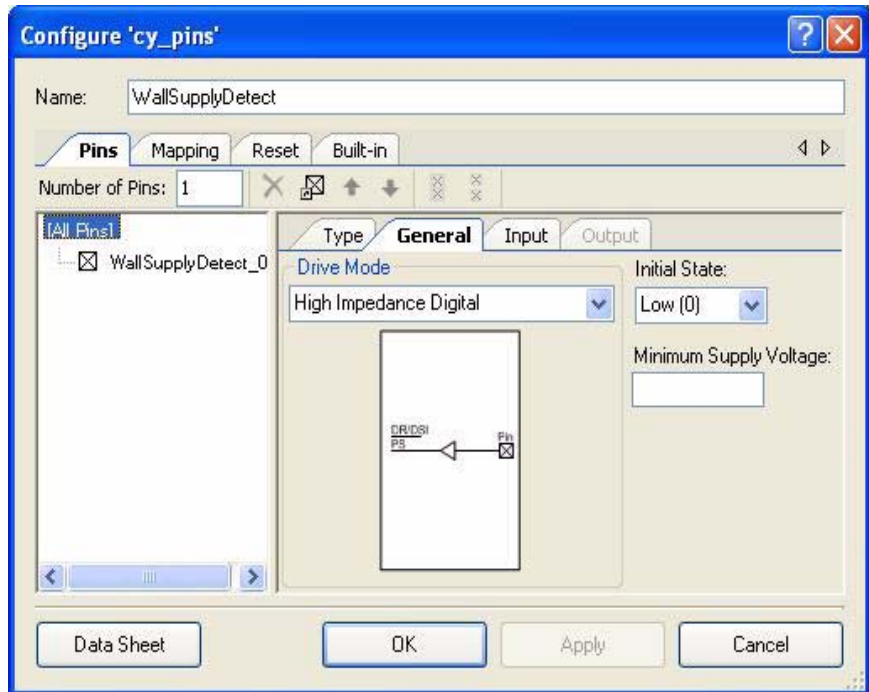

Figure 5-40. Wall Supply (Vin) Detect Configuration: Pin Type Tab

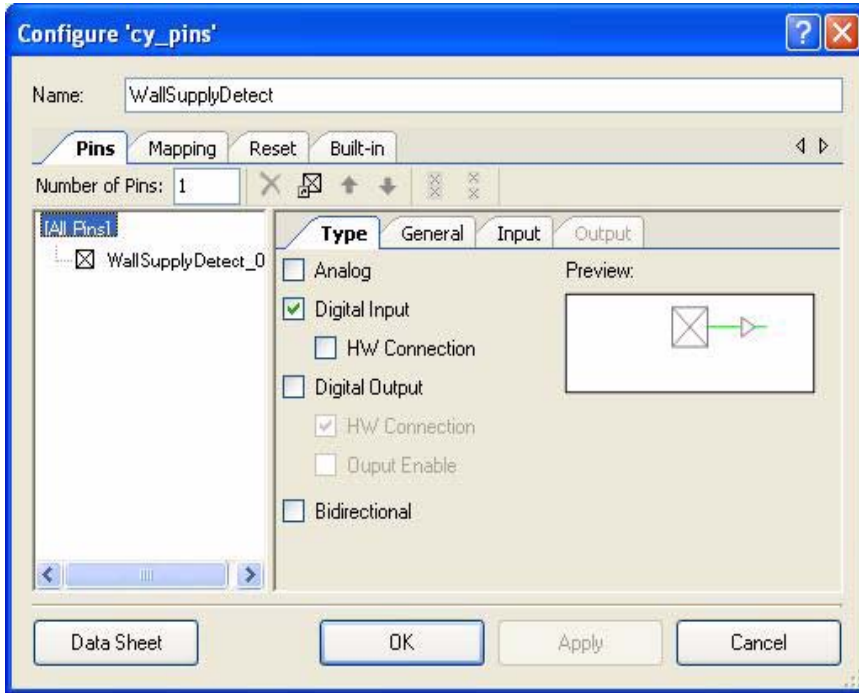
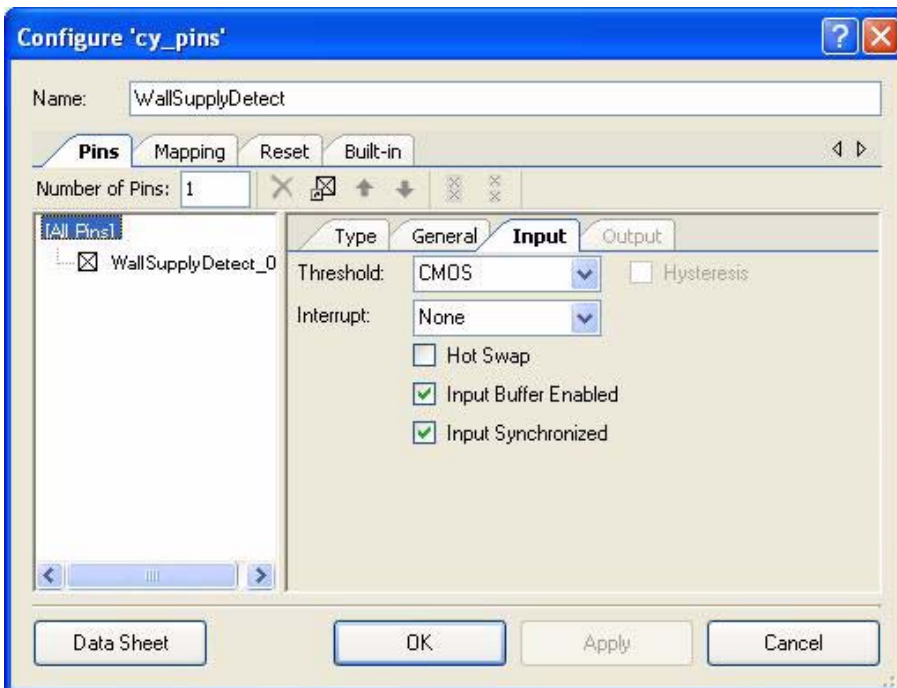

Figure 5-41. Wall Supply (Vin) Detect Configuration Input Tab



5.3.9.4 VBus Detect

The VBus Detect is configured to allow the firmware to poll the port with the Read API call. The VBus Detect signal is used in conjunction with the battery sense pins to help communicate the current power configuration to the project. The default Built-In settings are used.

Figure 5-42. VBus Detect Configuration: General Tab

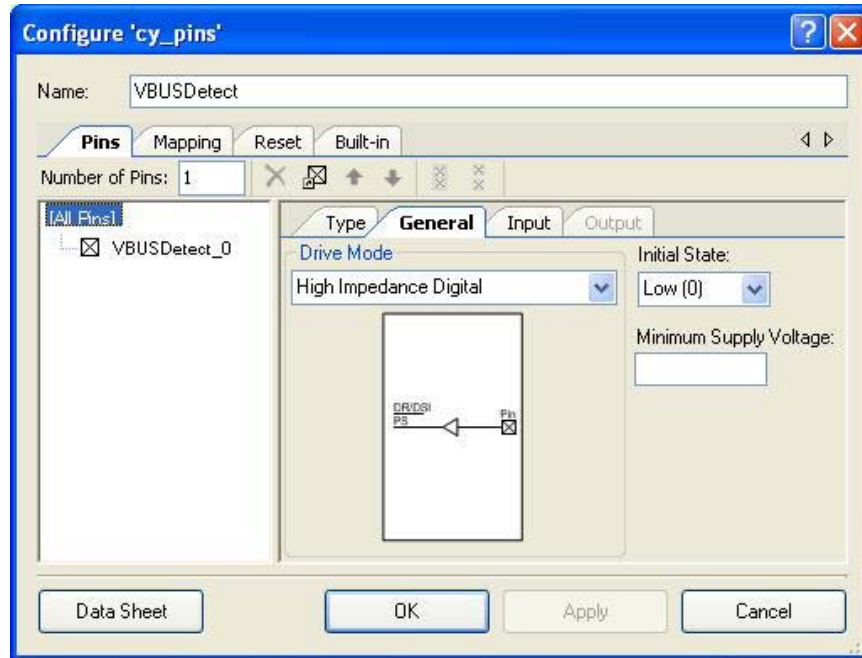
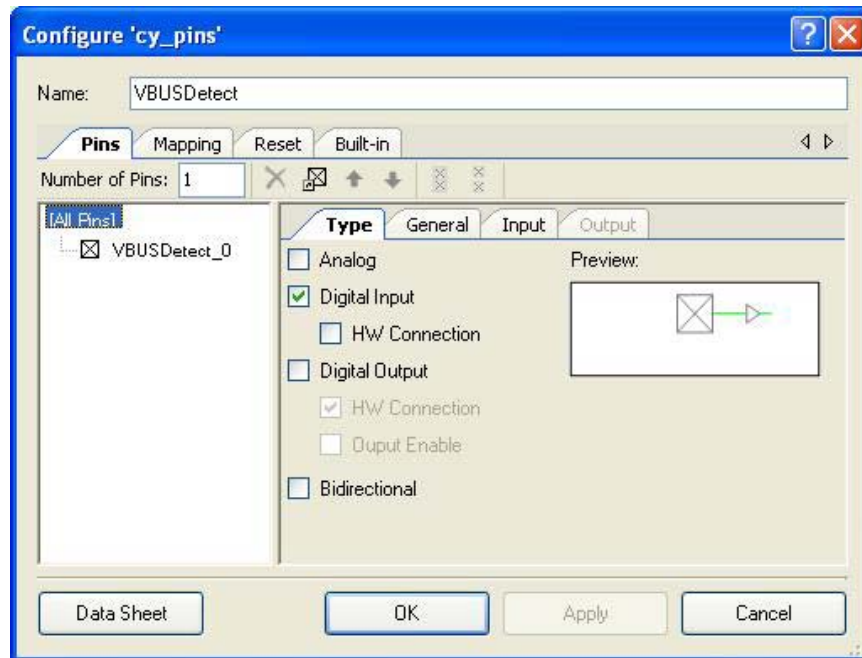

Figure 5-43. VBus Detect Configuration: Pin Type Tab



5.3.9.5 Digital Outputs

5.3.9.6 Accelerometer On

The firmware uses API to write to this port to turn on the accelerometer, enabling measurements. The default Built-In settings are used.

Figure 5-44. Accelerometer On Configuration: General Tab

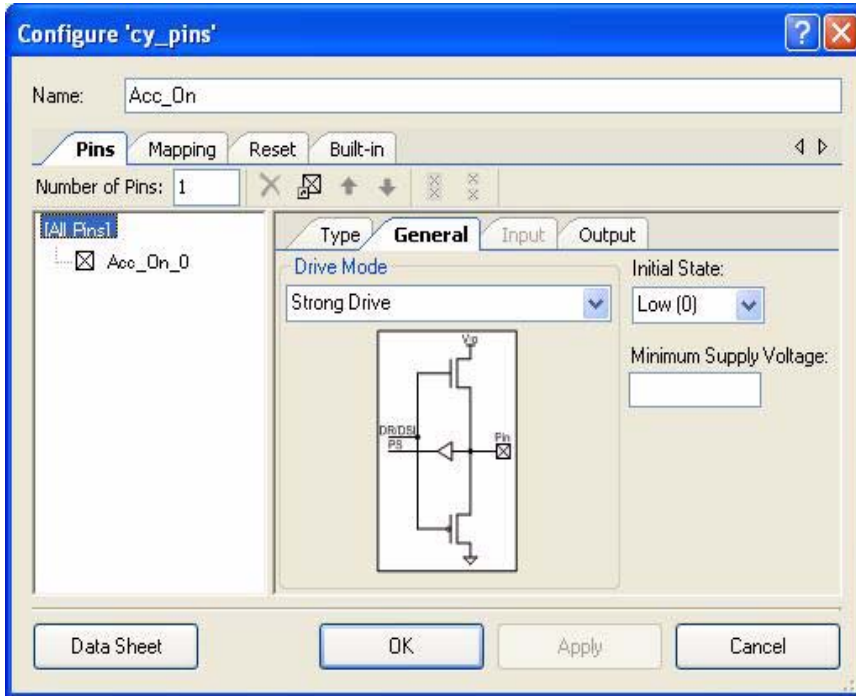

Figure 5-45. Accelerometer On Configuration: Pin Type Tab

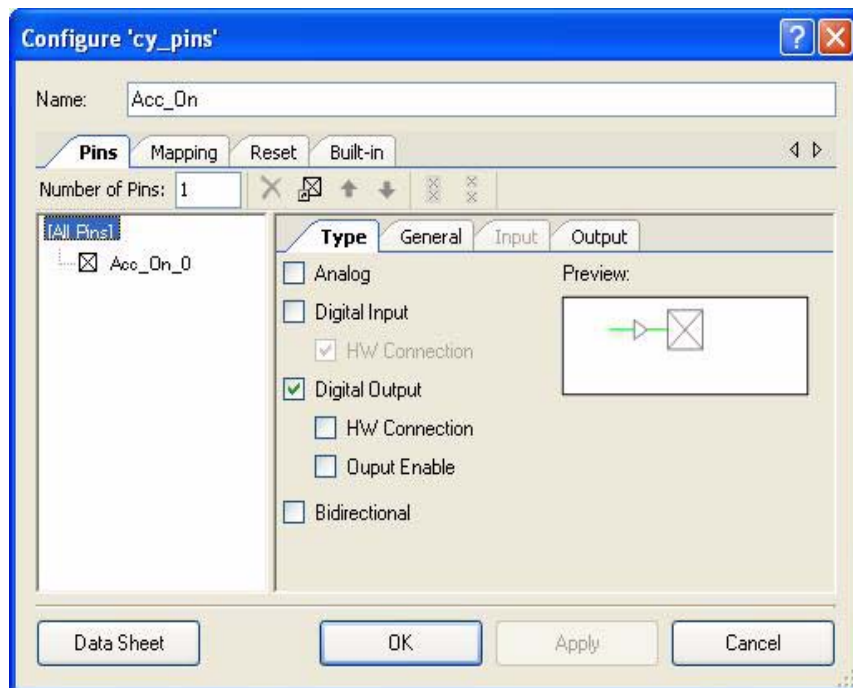
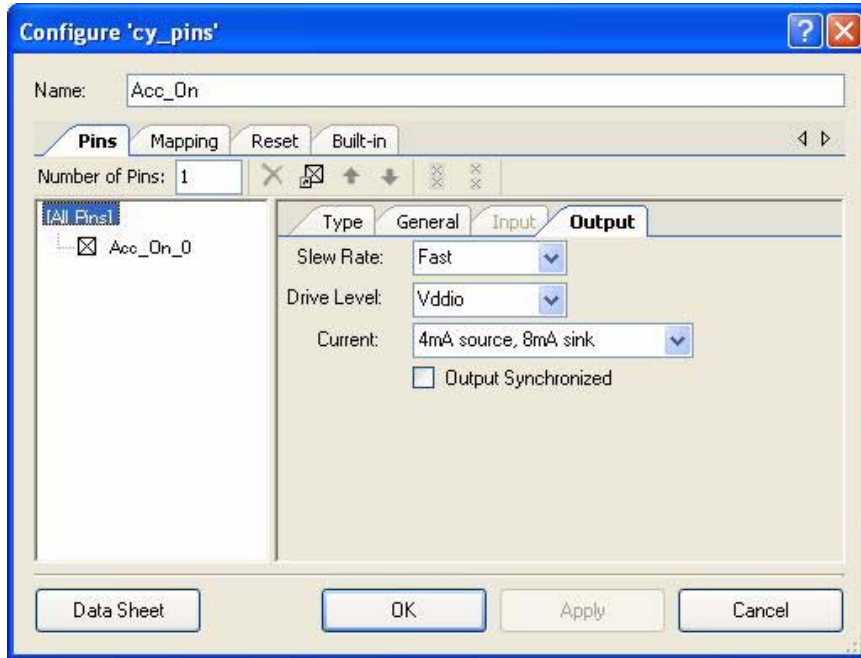

Figure 5-46. Accelerometer on Configuration: Output Tab



5.3.9.7 Buzzer In

This digital port provides a hardware path from PWM to the buzzer. It is configured to use hardware configuration and therefore does not require firmware code to activate it. Because the component is hardware configured, the output pin is exposed in the top level design, which allows a connection from the PWM to the digital port for output mapping. The default Built-In settings are used.

Figure 5-47. Buzzer In Configuration: General Tab

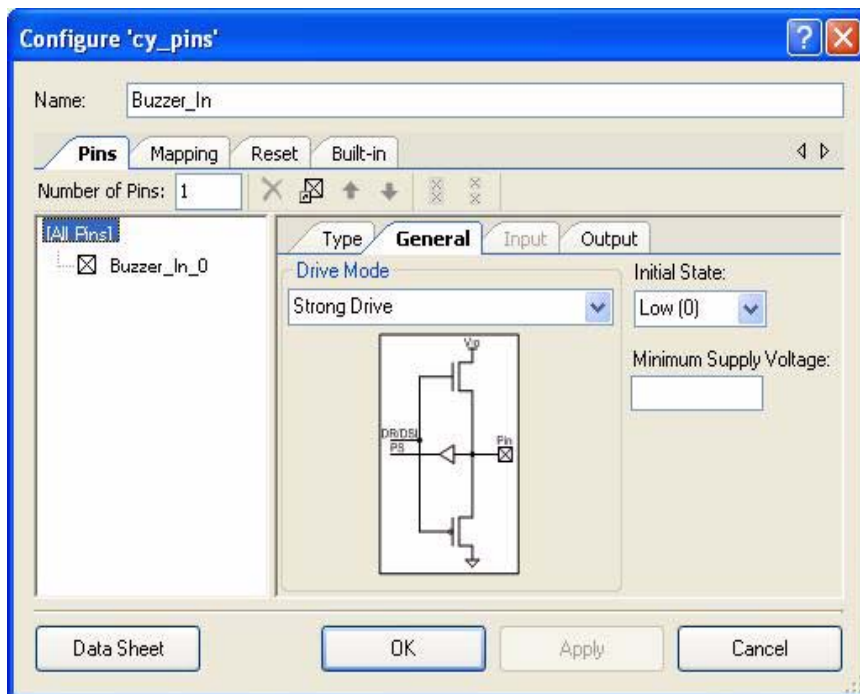

Figure 5-48. Buzzer In Configuration: Pin Type Tab

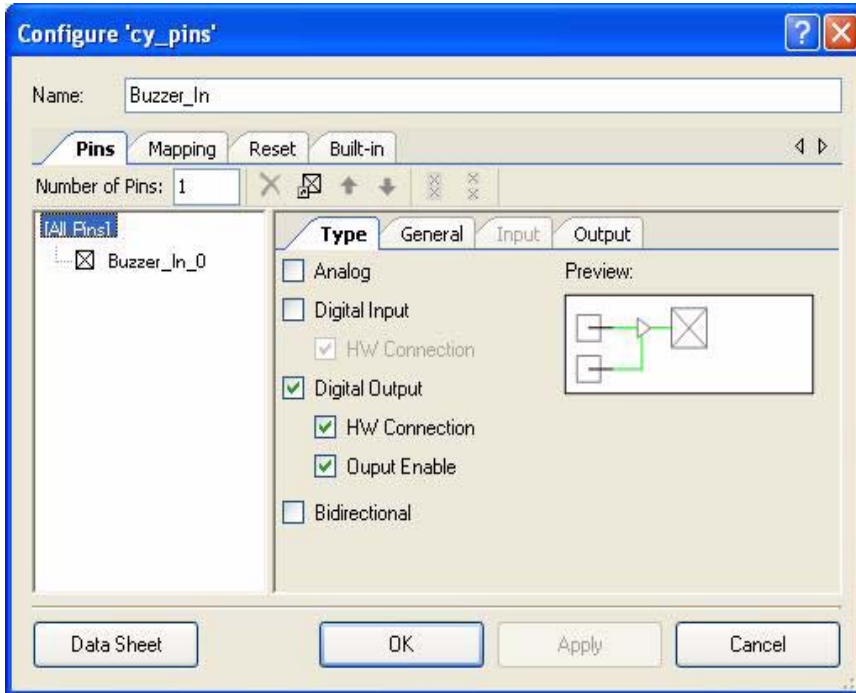
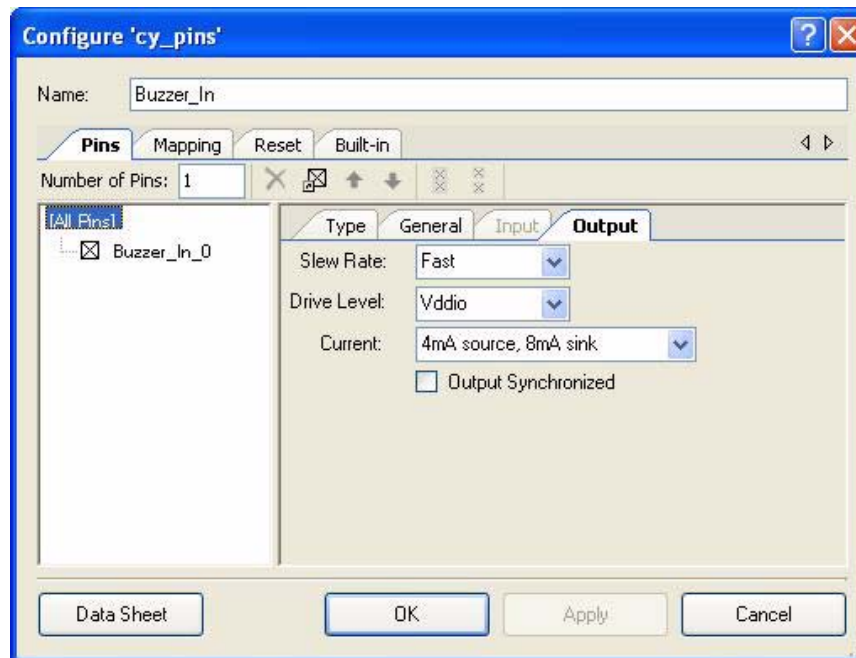

Figure 5-49. Buzzer In Configuration: Output Tab



5.3.9.8 Logic Level High for Buzzer In Output Enable

The Buzzer In digital output component requires a signal on the OE pin to enable the output.

5.3.10 Real Time Clock (RTC)

The RTC is minimally configured to use Sunday as the start day of the week. The firmware enables the RTC with hours, minutes, and seconds set to zero and the date set to January 1, 2000. After the clock is set, as long as power is provided to the PSoC 3 part, the real time is maintained with high accuracy. For the RTC to function, the 32 kHz crystal must be enabled in the System Clocks dialog.

The RTC function also has complete Alarm Clock settings. The project allows you to set an alarm for any time of the day. The project also provides options to enable or turn off an alarm that has started ringing. The alarm automatically stops ringing after five minutes.

The default Built-In settings are used.

Figure 5-50. Real Time Clock (RTC) Configuration: Basic Tab

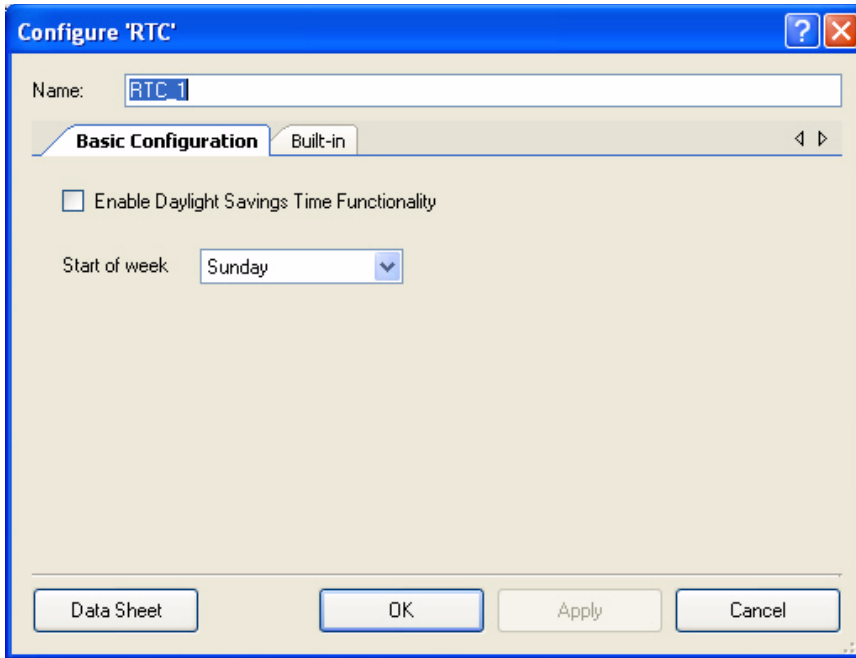

5.3.10.1 CapSense Buttons

There are four CapSense button capacitive pickup points on the LCD board. The silkscreen identifies each pickup point as a button in the range "+", "-", "SEL", and "RET". These buttons are used for menu navigation and data input.

This design uses the CapSense IDAC enabled as source method. The hardware is wired with an RBleed resistor to allow the IDAC disabled CapSense implementation. The hardware is wired for only one CMod circuit, so the serial CapSense method is used. For this implementation, the CapSense inputs are mapped to button functions. All the buttons are similarly configured.

CapSense button detection is performed using polling method. This requires the firmware to provide button sampling at each user loop in the code flow. The Timer user ISR can be enhanced to provided button sense events.

Note The CapSense CPS clock must not be greater than one half the projects bus clock selection (see [System Clocks on page 61](#)).

Figure 5-51. CapSense Configuration: General Tab

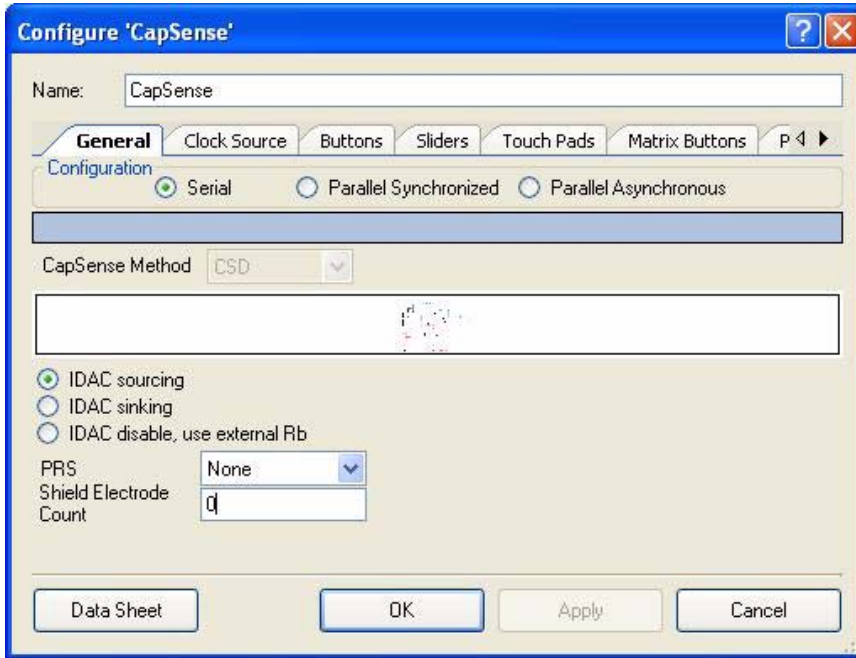

Figure 5-52. CapSense Configuration: Clock Source Tab

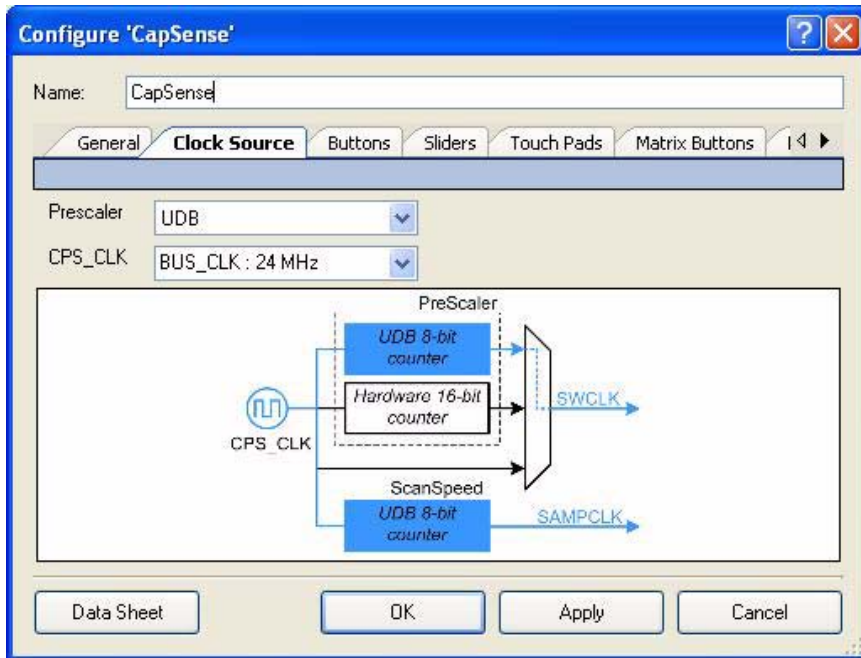

Figure 5-53. CapSense Configuration: Buttons Tab

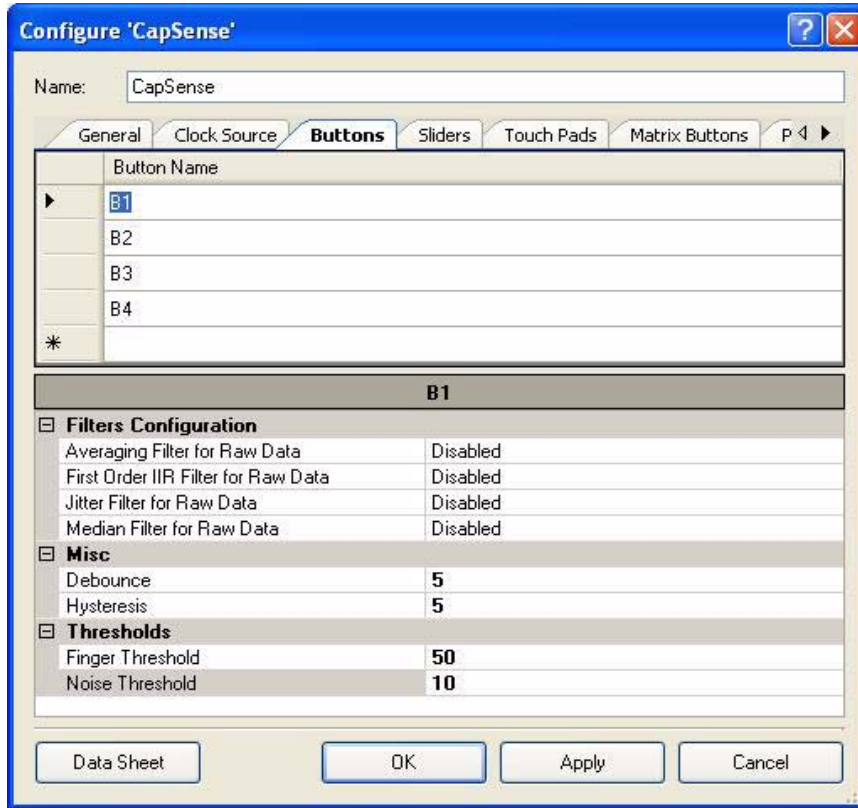
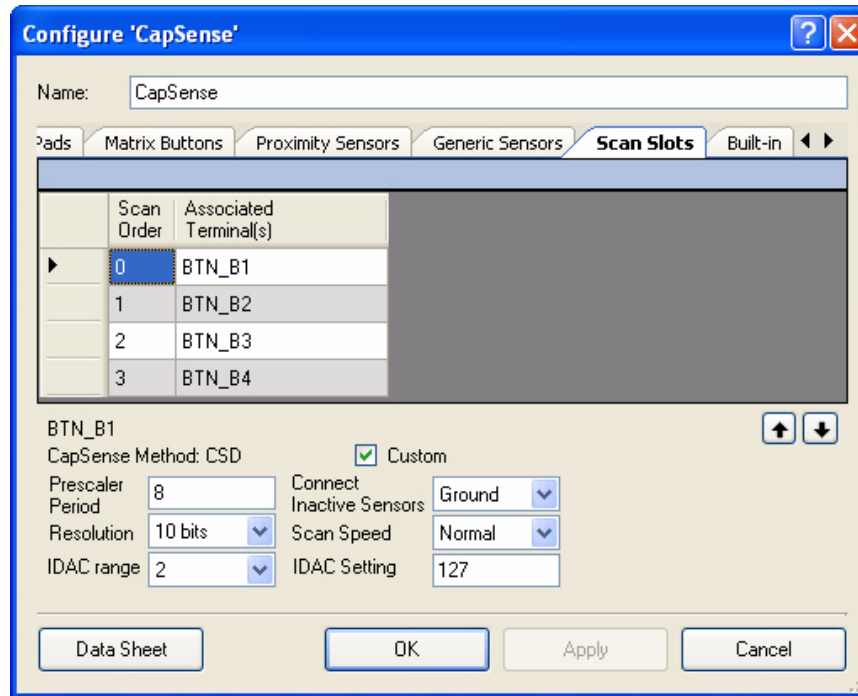

Figure 5-54. CapSense Configuration: Scan Slots Tab



5.3.11 EEPROM

This project uses the default Built-In settings. The EEPROM is 2 KB in two sectors [0, 1]. The project uses Sector 0 starting at the beginning of the sector. Each sector is addressed by 16-byte rows. The API provides a Write function to write data to the EEPROM and simple pointer code is used to provide read access row by row.

The project uses the following organization of the EEPROM for storing Punch saved high scores, display contrast level, and clock alarm settings.

Table 5-1. EEPROM Row Contents

Row	Data	Description
0	"0123456789ABCDEF"	Initialization String – if this string is missing then automatically re-initialize the EEPROM project data
1	High Score #1:Name, Score	Name is String Score is Long
2	High Score #2:Name, Score	Name is String Score is Long
3	High Score #3:Name, Score	Name is String Score is Long
4	High Score #4:Name, Score	Name is String Score is Long
5	High Score #5:Name, Score	Name is String Score is Long
6	Number of saved high scores	Byte (range [0 .. 5])
7	Accumulated score for averaging	Long
8	Average Score	Long
9	Current High Score Index	Byte (range [0 .. 4])
10	Clock Alarm (Hour, Minute)	Hour Byte (range [0 .. 23]) Minute Byte (range [0 .. 59])
11	Display Contrast Level	Byte (range [0 .. 10])
12	Clock Data (Day, Month Index, Year)	Day Byte (range [1 .. 31]) Month Index Byte (range [0..11] → [JAN .. DEC]) Year Byte (range [0 .. 99] → [2000 .. 2099])
13	Clock Alarm OFF/ON	Byte (range [0 .. 1] → [OFF, ON])
14	Clock Time (Hour, Minute)	Hour Byte (range [0 .. 23]) Minute Byte (range [0 .. 59])

Figure 5-55. EEPROM Default Settings



5.3.12 System Clocks

There are two system clocks to be enabled: the 32 kHz crystal clock for the RTC component and the PLL. The PLL is created from the IMO clock and is set high enough to allow CapSense operations. These clocks are enabled in the Configure Built In Clocks dialog.

To get to this dialog, select *SegLCD_project.cydwr* in the Workspace Explorer. Select the Clocks tab at the bottom of the workspace and then click **Edit Clock** on top of the workspace.

Figure 5-56. Enable XTAL 32 kHz for RTC and PLL

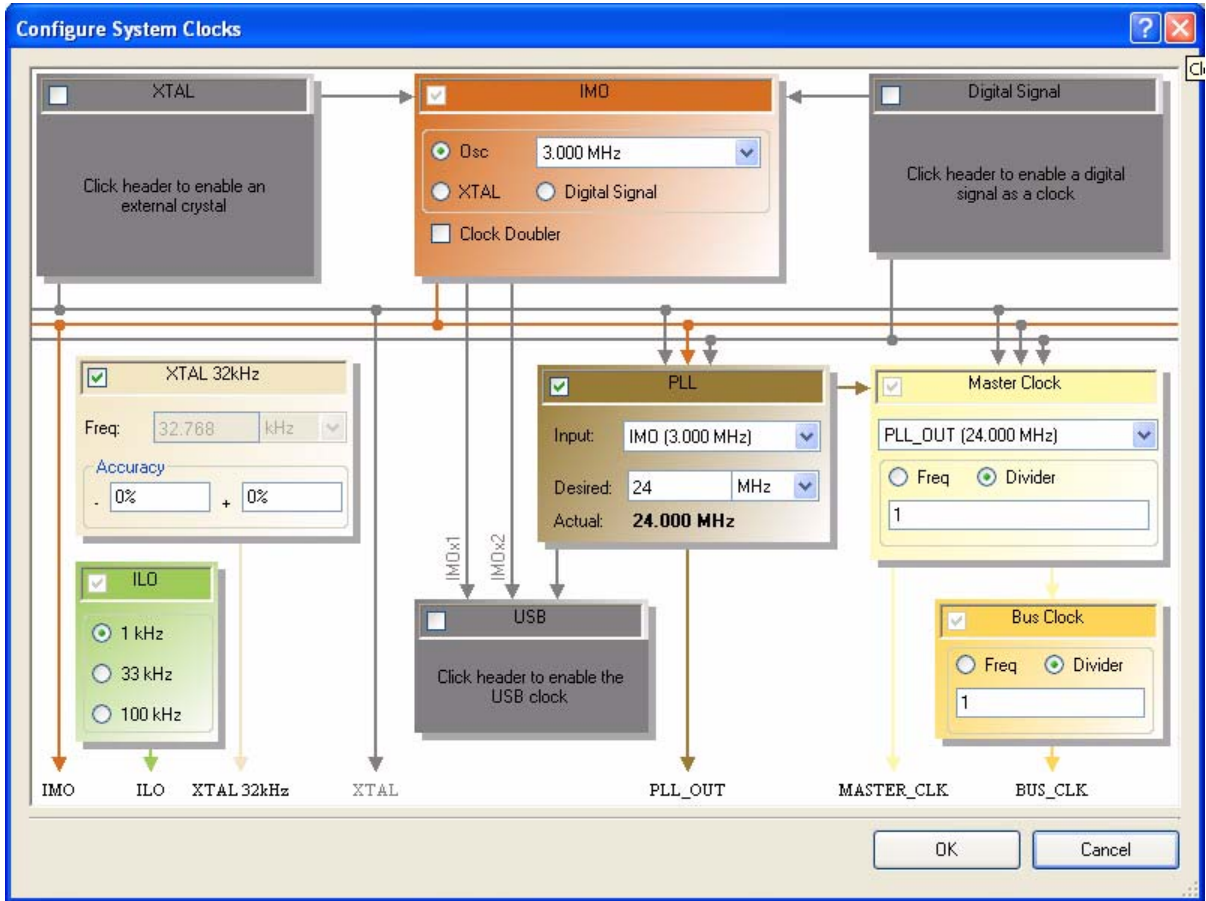

5.3.13 Pin Mapping

For the design to work, the PSoC3 pins internal connections must be mapped to the corresponding output connections. This is done using the Pins dialog.

To get to this dialog, select the *SegLCD_project.cydwr* file in the Workspace Explorer. Select the Pins tab at the bottom of the workspace. To connect a pin grab and drop one of the unassigned pins from the pin list panel on the right side onto an unassigned target pin stub on the PSoC3 block in the center panel. To remove a connection, right click the assigned target pin stub and unlock the signal name.

Figure 5-57. Pin Connection Mapping Page 1

Alias	Name	Pin	Lock
\SegLCD:Coa\115		P1[7]	<input checked="" type="checkbox"/>
\SegLCD:Coa\114		P1[6]	<input checked="" type="checkbox"/>
\SegLCD:Coa\113		P0[0]	<input checked="" type="checkbox"/>
\SegLCD:Coa\112		P0[1]	<input checked="" type="checkbox"/>
\SegLCD:Coa\111		P0[2]	<input checked="" type="checkbox"/>
\SegLCD:Coa\110		P0[3]	<input checked="" type="checkbox"/>
\SegLCD:Coa\9		P0[4]	<input checked="" type="checkbox"/>
\SegLCD:Coa\8		P0[5]	<input checked="" type="checkbox"/>
\SegLCD:Coa\7		P6[7]	<input checked="" type="checkbox"/>
\SegLCD:Coa\6		P6[6]	<input checked="" type="checkbox"/>
\SegLCD:Coa\5		P6[5]	<input checked="" type="checkbox"/>
\SegLCD:Coa\4		P6[4]	<input checked="" type="checkbox"/>
\SegLCD:Coa\3		P2[7]	<input checked="" type="checkbox"/>
\SegLCD:Coa\2		P2[6]	<input checked="" type="checkbox"/>
\SegLCD:Coa\1		P2[5]	<input checked="" type="checkbox"/>
\SegLCD:Coa\0		P2[2]	<input checked="" type="checkbox"/>
\SegLCD:Seg\127		P5[0]	<input checked="" type="checkbox"/>
\SegLCD:Seg\126		P5[1]	<input checked="" type="checkbox"/>
\SegLCD:Seg\125		P5[2]	<input checked="" type="checkbox"/>
\SegLCD:Seg\124		P5[3]	<input checked="" type="checkbox"/>
\SegLCD:Seg\123		P5[4]	<input checked="" type="checkbox"/>
\SegLCD:Seg\122		P5[5]	<input checked="" type="checkbox"/>
\SegLCD:Seg\121		P5[6]	<input checked="" type="checkbox"/>
\SegLCD:Seg\120		P5[7]	<input checked="" type="checkbox"/>
\SegLCD:Seg\119		P15[1]	<input checked="" type="checkbox"/>
\SegLCD:Seg\118		P15[0]	<input checked="" type="checkbox"/>
\SegLCD:Seg\117		P2[3]	<input checked="" type="checkbox"/>
\SegLCD:Seg\116		P2[4]	<input checked="" type="checkbox"/>
\SegLCD:Seg\115		P0[6]	<input checked="" type="checkbox"/>
\SegLCD:Seg\114		P0[7]	<input checked="" type="checkbox"/>
\SegLCD:Seg\113		P4[2]	<input checked="" type="checkbox"/>
\SegLCD:Seg\112		P4[3]	<input checked="" type="checkbox"/>

Figure 5-58. Pin Connection Mapping Page 2

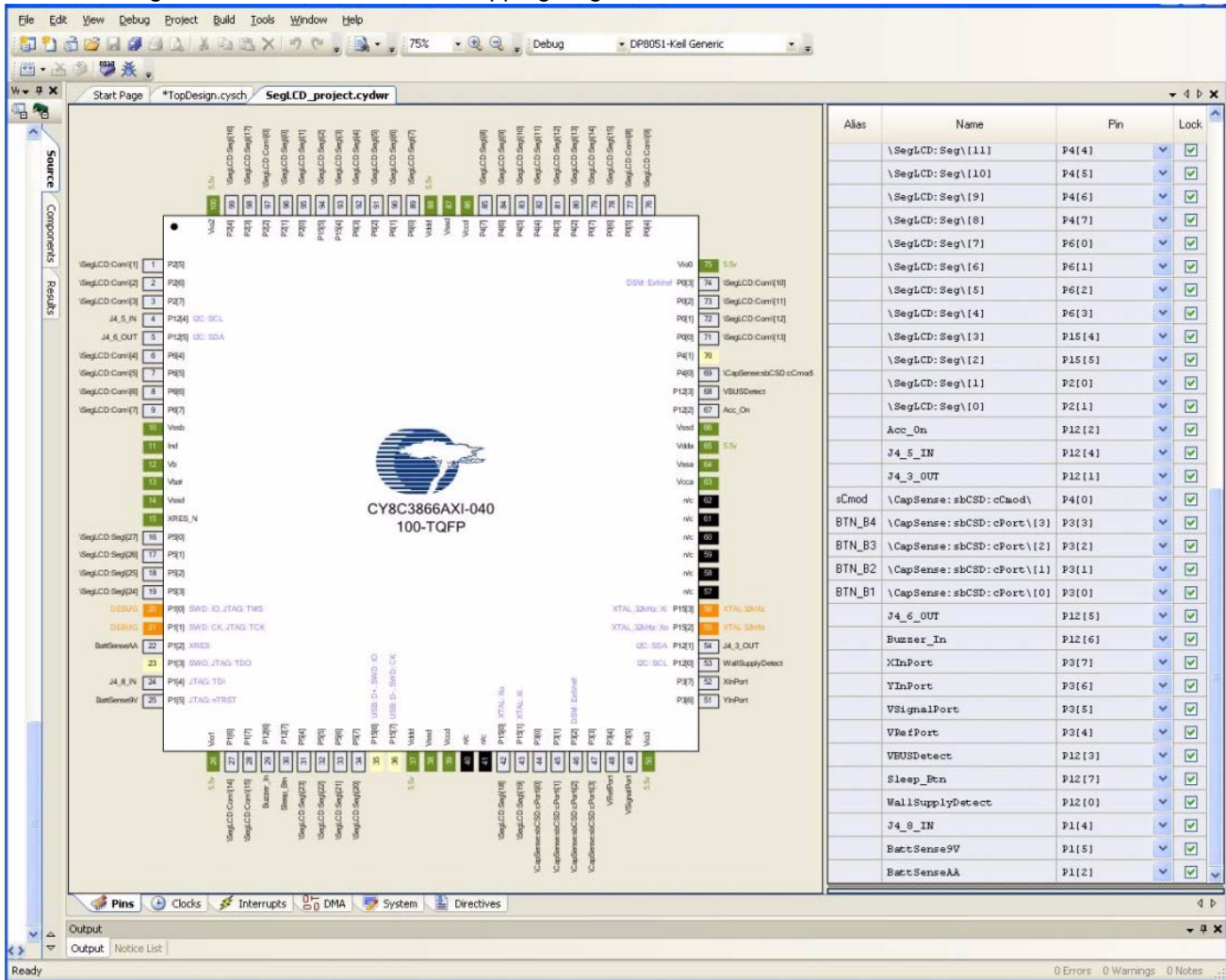

Alias	Name	Pin	Lock
\SegLCD: Seg\111		P4(4)	<input checked="" type="checkbox"/>
\SegLCD: Seg\110		P4(5)	<input checked="" type="checkbox"/>
\SegLCD: Seg\19		P4(6)	<input checked="" type="checkbox"/>
\SegLCD: Seg\18		P4(7)	<input checked="" type="checkbox"/>
\SegLCD: Seg\7		P6(0)	<input checked="" type="checkbox"/>
\SegLCD: Seg\16		P6(1)	<input checked="" type="checkbox"/>
\SegLCD: Seg\5		P6(2)	<input checked="" type="checkbox"/>
\SegLCD: Seg\14		P6(3)	<input checked="" type="checkbox"/>
\SegLCD: Seg\3		P15(4)	<input checked="" type="checkbox"/>
\SegLCD: Seg\12		P15(5)	<input checked="" type="checkbox"/>
\SegLCD: Seg\11		P2(0)	<input checked="" type="checkbox"/>
\SegLCD: Seg\10		P2(1)	<input checked="" type="checkbox"/>
Acc_On		P12(2)	<input checked="" type="checkbox"/>
J4_5_IN		P12(4)	<input checked="" type="checkbox"/>
J4_3_OUT		P12(1)	<input checked="" type="checkbox"/>
sCMod	\CapSense: sbCSD: cCMod\	P4(0)	<input checked="" type="checkbox"/>
BTN_B4	\CapSense: sbCSD: cPort\3	P3(3)	<input checked="" type="checkbox"/>
BTN_B3	\CapSense: sbCSD: cPort\2	P3(2)	<input checked="" type="checkbox"/>
BTN_B2	\CapSense: sbCSD: cPort\1	P3(1)	<input checked="" type="checkbox"/>
BTN_B1	\CapSense: sbCSD: cPort\0	P3(0)	<input checked="" type="checkbox"/>
J4_6_OUT		P12(5)	<input checked="" type="checkbox"/>
Buzzer_In		P12(6)	<input checked="" type="checkbox"/>
XInPort		P3(7)	<input checked="" type="checkbox"/>
YInPort		P3(6)	<input checked="" type="checkbox"/>
VSignalPort		P3(5)	<input checked="" type="checkbox"/>
VInPort		P3(4)	<input checked="" type="checkbox"/>
VBUSDetect		P12(3)	<input checked="" type="checkbox"/>
Sleep_Btn		P12(7)	<input checked="" type="checkbox"/>
WallSupplyDetect		P12(0)	<input checked="" type="checkbox"/>
J4_0_IN		P1(4)	<input checked="" type="checkbox"/>
Bat:Sense9V		P1(5)	<input checked="" type="checkbox"/>
Bat:SenseAA		P1(2)	<input checked="" type="checkbox"/>

5.3.14 Low Power Operation

The design also includes the ability to go to low power operation. When the device goes to low power operation, only the RTC component is left running. It periodically wakes up the PSoC enough to strobe the ZZZ icon on and off to indicate that the device is in low power mode. To bring the device out of low power mode, press and hold the push button switch. When the device wakes up at the next ZZZ strobe interval, it samples the push button and return to normal operations if the button is pressed.

5.3.15 Low Power Entry

The following tasks must be performed prior to entering low power:

1. Set 32 kHz clock to low power mode (API call).
2. Set trim registers (sleep and wake trims).
3. Stop timer components (except RTC).
4. Disable component clocks.
5. Deactivate accelerometer.
6. Deactivate thermistor VDAC reference generator.

7. Stop CapSense.
8. Set segment LCD to low power mode (API call).
9. Call CySleep library API.

5.3.16 Automatic Low Power Entry

The firmware automatically puts the device into low power mode after 10 minutes of no user activity (no CapSense button presses). The exception is when you are in the RTC/TEMP mode. If the device is powered by a wall supply, then the RTC/TEMP mode blocks entering low power.

However, if the device is powered by a battery source, then the project goes into automatic low power mode even if user is in the RTC/TEMP mode. The automatic low power mode is a sleep operation.

5.3.17 Manual Low Power Entry

When the device is in normal operation, if the push button is pressed and the device is not in the RTC/TEMP mode, then the device enters the low power operation. If the device is powered by a wall supply, the RTC/TEMP mode blocks entering low power.

However, if the device is powered by a battery source, then the project goes into manual low power mode even if the clock is displayed. The pushbutton low power mode is a sleep operation.

5.3.18 Periodic Wake and Return to Sleep

The RTC clocking continues during the sleep low power mode. This allows the RTC clock to continue interrupting the PSoC 3 every second. The PSoC 3 RTC interrupt calls the project interrupt service code which counts RTC interrupt events. Normally, the interrupt service simply returns without action and the device automatically re-enters sleep mode.

However, on every fourth RTC interrupt, the interrupt service reactivates the LCD segment component, turns on the ZZZ icon for three-fourths of a second, and deactivates the LCD segment component. The device then re-enters the sleep mode.

5.3.19 Wake from Sleep

Press the pushbutton to wake from sleep. The pushbutton interrupt wakes up the PSoC 3 device, which resumes processing from the point it went into low power mode. The clock time is preserved during automatic sleep.

5.3.20 Low Power Exit

The following tasks must be performed after waking from low power to continue normal operations:

1. Set segment LCD to low power mode (API call).
2. Restart CapSense.
3. Reactivate component clocks.
4. Restart timer components.
5. Restart ADC component.

5.4 Source Code Description

5.4.1 Top Level Functional Description

On startup, the main process starts the necessary components that operate the main program menu. This includes the LCD segment display component and CapSense buttons. The main function then enters the continuous Main Loop.

5.4.1.1 Main Loop

Figure 5-59 shows the flow of the main code. The Main Loop displays the top level modes of operation in sequential order. These modes are:

- Punch Gauge (PUNCH)
- Time/Temperature (RTC/TEMP)
- Contrast Control (CONTRAST)
- LCD Demo (LCD DEMO).

Press the "+" and "-" buttons to select from one of the modes. A mode is entered when you press the **SEL** button while that mode name is displayed. On selecting a mode of operation, the main process transfers control to a sub mode control level with sub mode menus and controls.

Figure 5-59. Main Code Flow

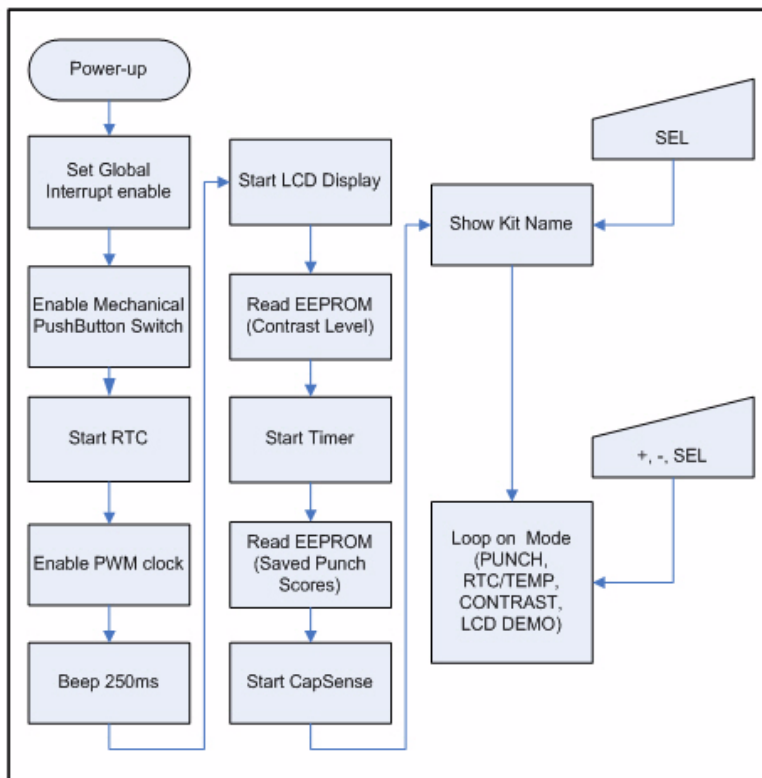

5.4.1.2 Punch Gauge Mode

Figure 5-60 shows the flow of the Punch Gauge sub mode code. On entering the Punch Gauge mode, the Punch process enters a continuous loop that displays in sequential order the sub modes. These sub modes are

- Throw Punch (1:GAUGE)
- Show High Score (1:HIGH)
- Recall Highest Scores (1:RECALL)
- Clear the saved high scores (1:CLEAR)

Use the "+" and "-" buttons to select from one of the Punch Gauge sub modes. A sub mode is entered when you press **SEL** while that sub mode name is displayed. Pressing **RET**, exits the Punch Gauge sub mode and re-enters the Main Flow.

All the Punch processes display characters on the matrix display.

Figure 5-60. Punch Code Flow

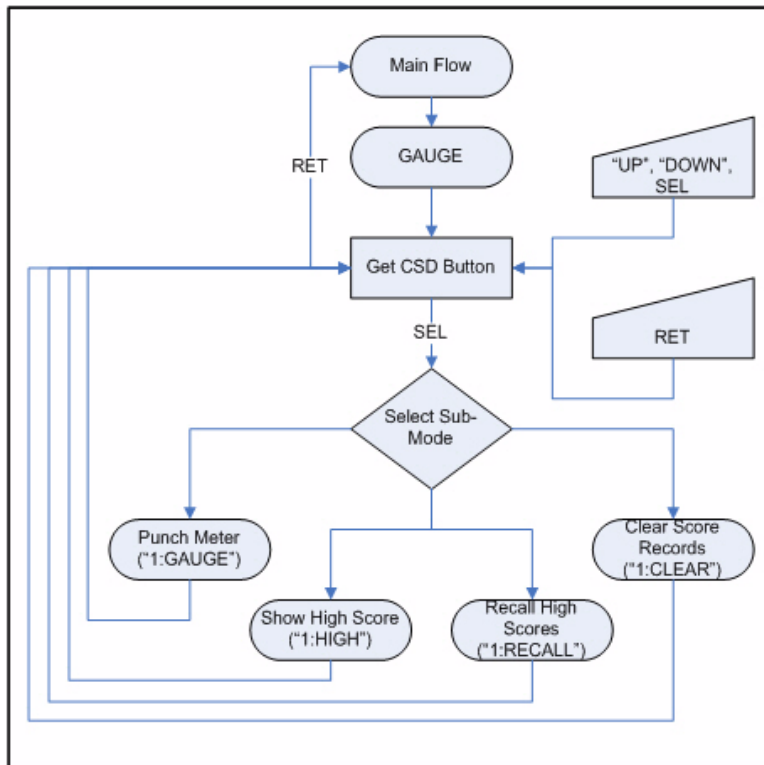

5.4.1.3 RTC/TEMP

Figure 5-61 shows the RTC code flow and Figure 5-62 shows the Date/Temperature code flow. On entering the Time/Temperature mode, the RTC process displays the Time/Temperature sub modes in sequential order. The sub modes are:

- Show Time (2:Clock)
- Set Time (2:SetClk)
- Set Date(2:SetDat)
- Set Alarm (2:SetAlm)
- Turn Alarm On/Off (2:Alarm).

Press the "+" and "-" buttons to select from one of the sub modes. A sub mode is entered when you press **SEL** button while that sub mode name is displayed. Upon selecting a sub mode operation, the Time/Temperature mode transfers control to a sub mode control level with sub mode menus and controls.

Figure 5-61. RTC Code Flow

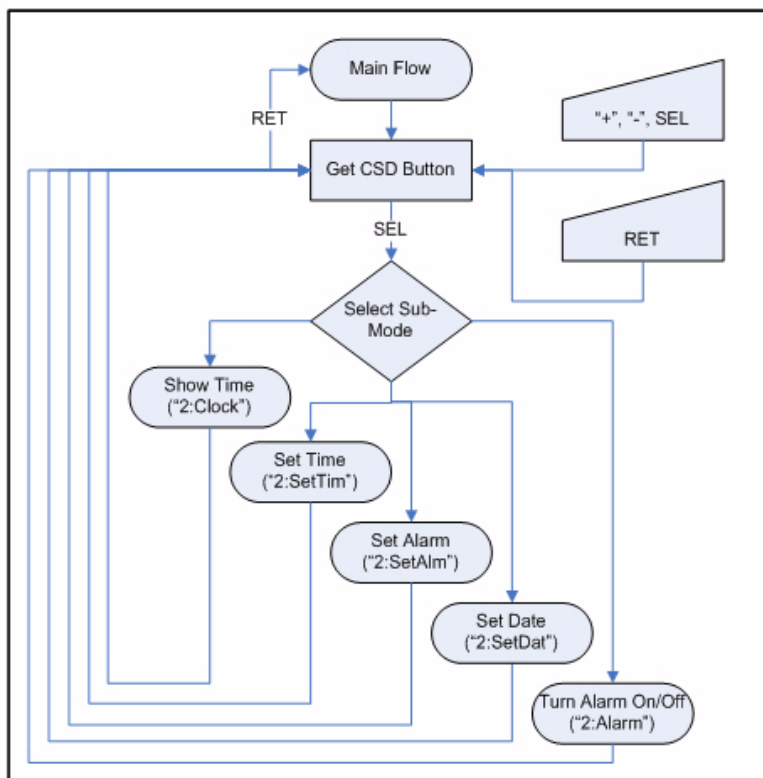
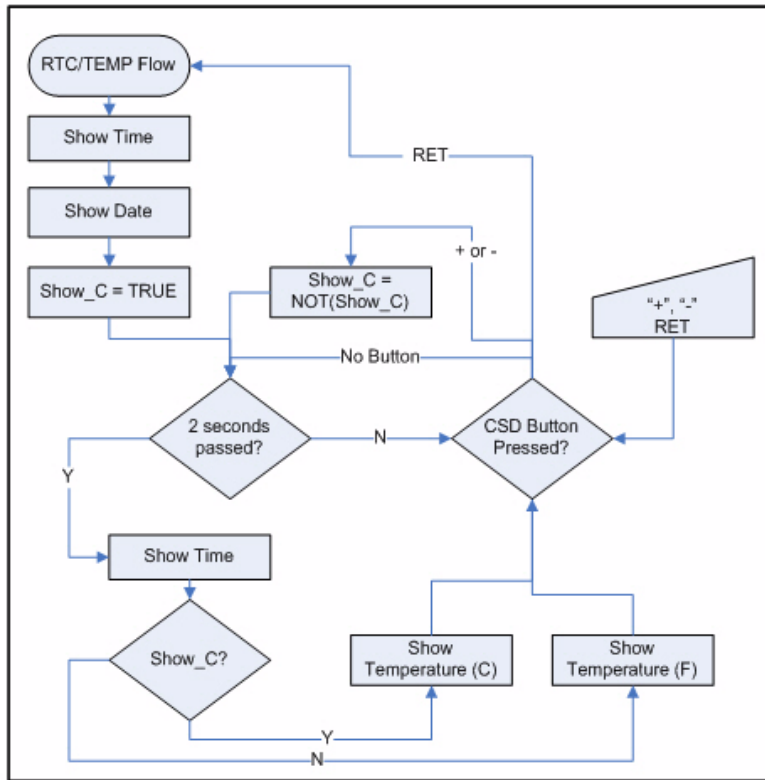

Figure 5-62. Clock Show Time and Date/Temperature Flow



5.4.1.4 Contrast Control Mode

Refer to [Figure 5-63](#) for the contrast control code flow. On entering the Contrast Control mode, the contrast process displays "Level = X" in the matrix display. The X is the current contrast level, which is a number in the range 0 to 10. The Progress Bar icons are turned on from left to right to display the contrast level. The "+" and "-" buttons control the increment and decrement of the contrast level.

Figure 5-63. Contrast Control Flow

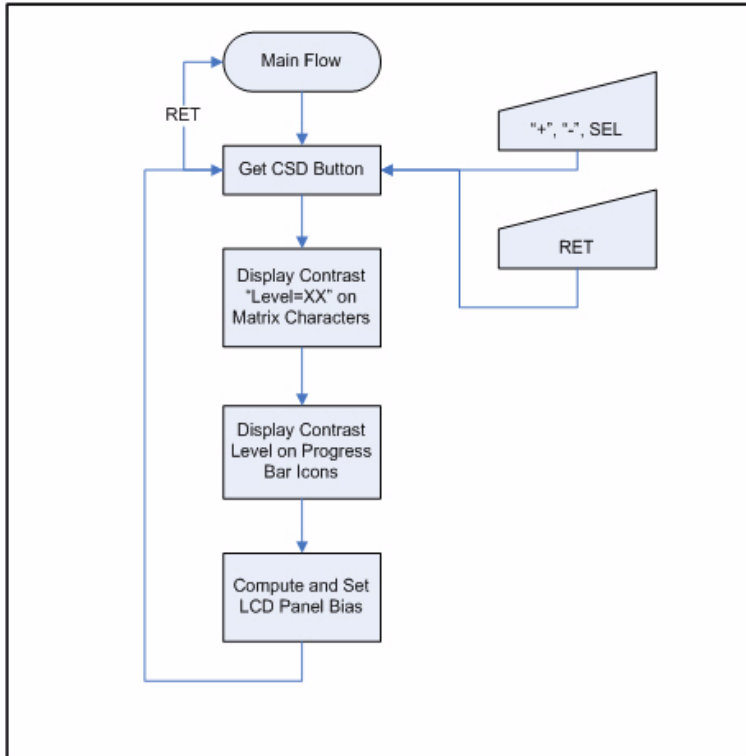

5.4.1.5 LCD Demonstration Mode

Figure 5-64. LCD Demonstration Code Flow

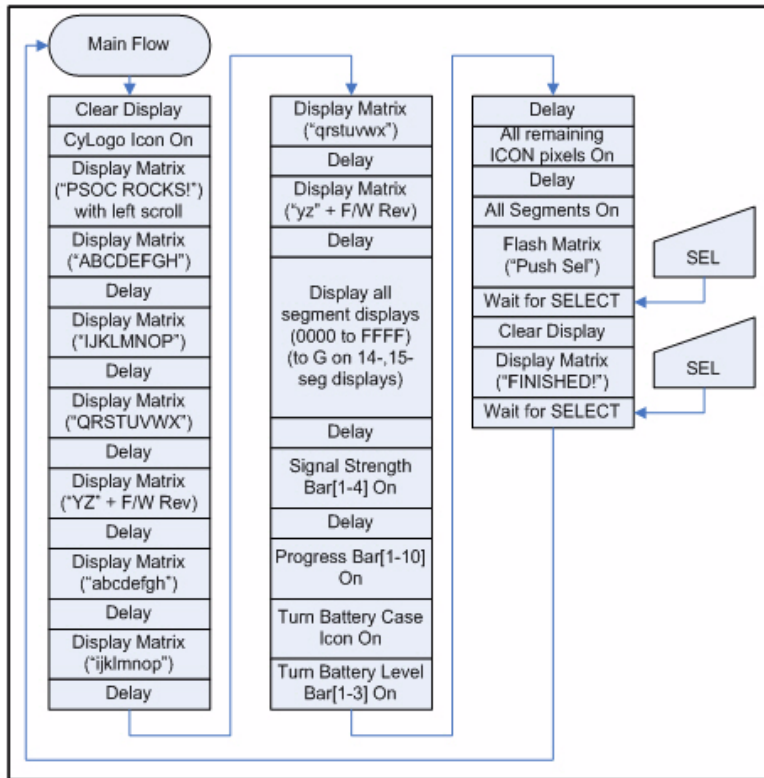

5.4.1.6 Register Descriptions

There are several low power handling registers in PSoC 3 that must be directly set by the project code to allow proper sleep entry and wakeup exit. All other register activity is performed by the component the API calls.

Table 5-2. Register Descriptions

Register Component Name	Register Silicon Name	Register Address	Write Value	Description
CYDEV_MFGCFG_P WRSYS_SLP_TR	PWR- SYS.SLP_TR	0x4683	0x03	Sleep regulator trim: 1. Regulator trim = 3
CYDEV_MFGCFG_P WRSYS_WAKE_TR0	PWR- SYS.WAKE_TR0	0x4685	0xFF	Wake trim: 1. Wake holdoff interval multiplier=16 2. Wake timeout interval multiplier=16
CYDEV_MFGCFG_P WRSYS_WAKE_TR1	PWR- SYS.WAKE_TR1	0x4686	0x38	Wake trim: 1. Wake precount=7 2. Wake IMO frequency = 12 MHz

A.2 Segment Lettering Information

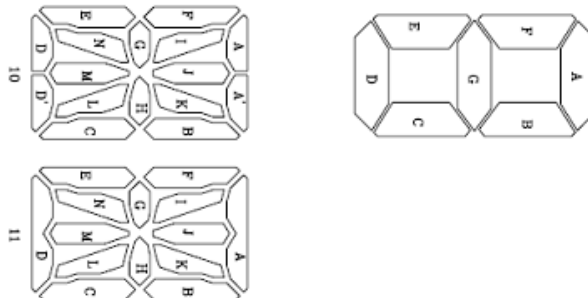
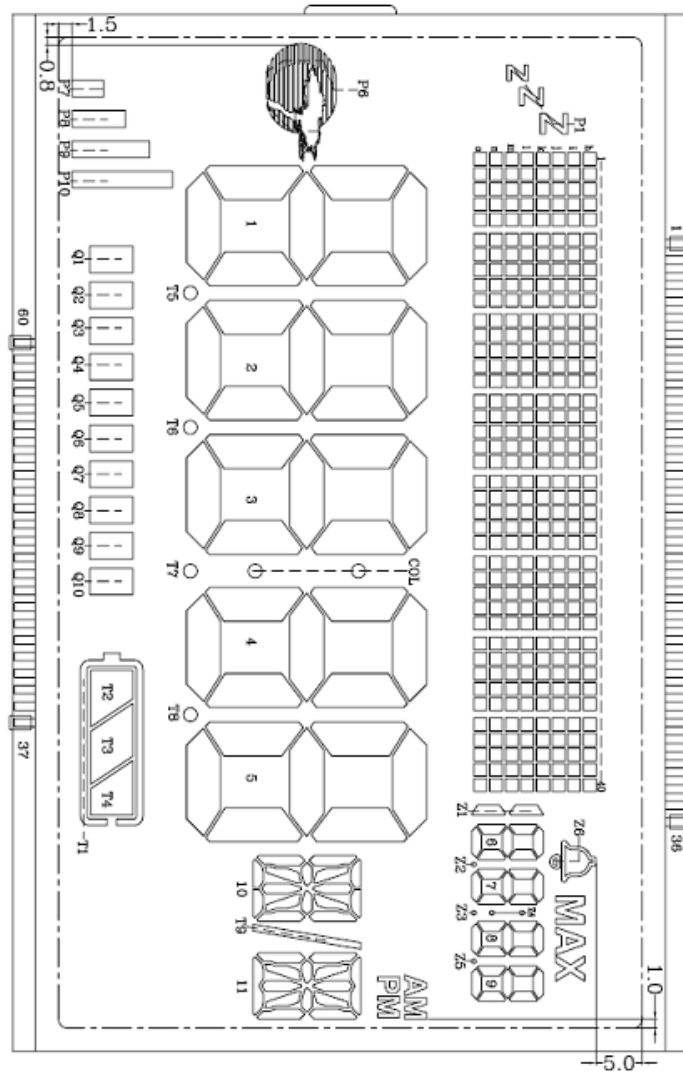

A.3 Schematic

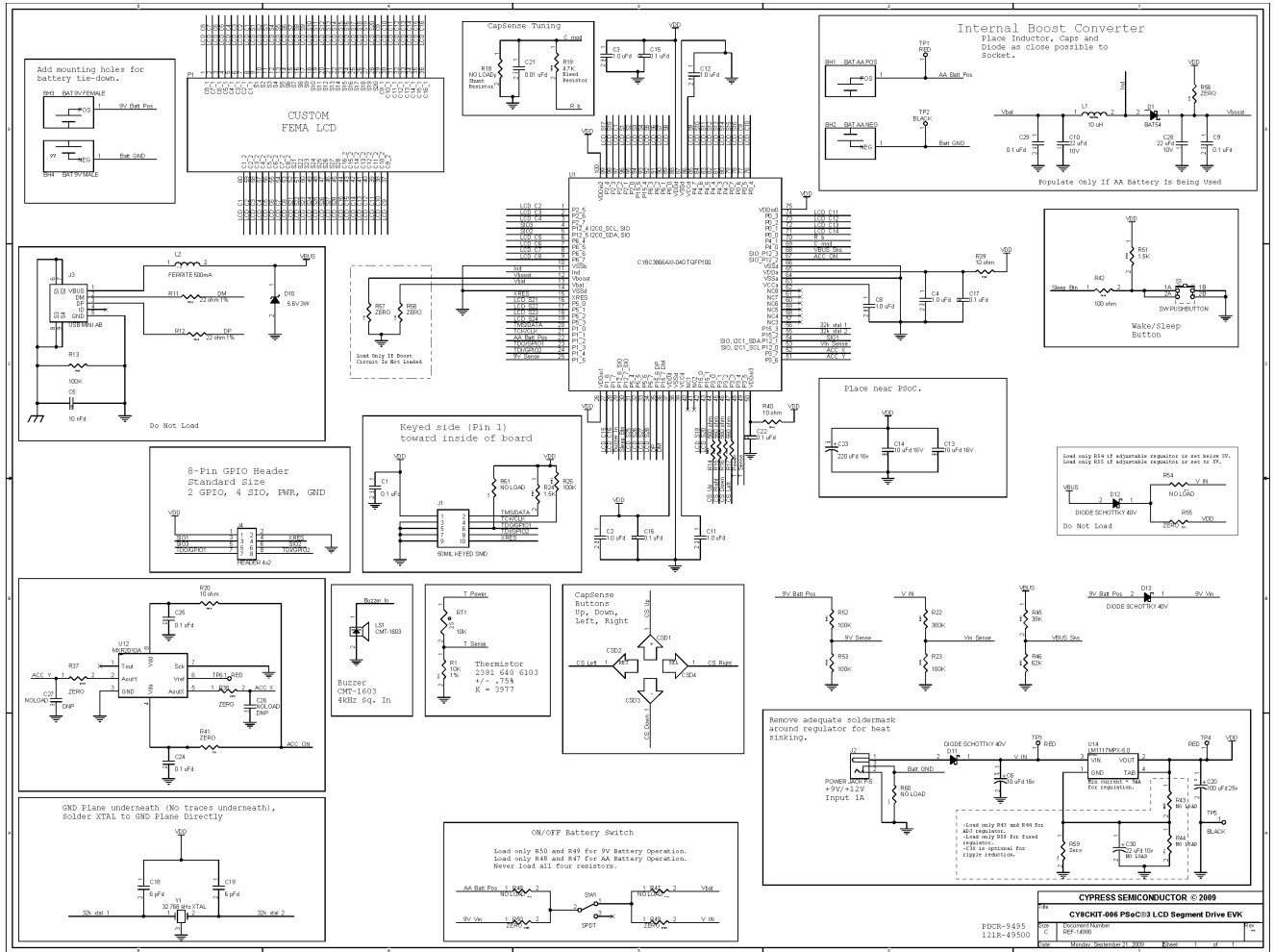

A.4 BOM

CY8CKIT-006 PSoC3/5 LCD Driver

121R-49500 Revision: 5

REF-14890 Revision: 5

Item	Qty.	Reference	Part	Manufacturer	Mfrg. Part No.	RoHS	Sub
1	1	BH3	BATTERY HOLDER 9V Female PC MT	Keystone Elec- tronics	594	Y	Y
2	1	BH4	BATTERY HOLDER 9V Male PC MT	Keystone Elec- tronics	593	Y	Y
3	1	C1	CAP .10UF 16V CERAMIC X7R 0603	Kemet	C0603C104J 4RACTU	Y	Y
4	6	C2,C3,C4,C 8,C11,C12	CAP CERAMIC 1.0UF 10V X5R 0603	Kemet	C0603C105K 8PACTU	Y	Y
5	1	C6	CAP 10UF 16V TANTA- LUM 10% 3216	AVX	TAJA106K01 6R	Y	Y
6	2	C13,C14	CAP CER 10UF 16V X5R 0805	Murata Electron- ics North Amer- ica	GRM21BR61 C106KE15L	Y	Y
7	4	C15,C16,C1 7,C22	CAP .10UF 10V CERAMIC X5R 0402	Kemet	C0402C104K 8PACTU	Y	Y
8	2	C18,C19	CAP 6PF 50V CERAMIC NPO 0603	Panasonic - ECG	ECJ- 1VC1H060D	Y	Y
9	1	C20	CAP ELECT 100UF 25V FK SMD	Panasonic - ECG	EEE- FK1E101P	Y	Y
10	1	C21	CAP 0.01UF 50V CERAMIC X7R 0603	Panasonic	ECJ- 1VB1H103K	Y	Y
11	1	C23	CAP 220UF 16V TANTA- LUM 20% 7343H	AVX	TAJE227M01 6R	Y	Y
12	2	C24,C25	CAP .1UF 16V CERAMIC Y5V 0402	Panasonic - ECG	ECJ- 0EF1C104Z	Y	Y
13	2	D11,D13	DIODE SCHOTTKY 40V 1.5A SMA	Vishay IR	10MQ040NT RPBF	Y	Y
14	1	J1	CONN HEADER 10 PIN 50MIL KEYED SMD	Samtec	FTSH-105- 01-L-DV-K	Y	Y
15	1	J2	CONN JACK POWER 2.1mm PCB RA	CUI	PJ-102A	Y	Y

Item	Qty.	Reference	Part	Manufacturer	Mfrg. Part No.	RoHS	Sub
16	1	J4	CONN HEADER 4x2POS .100 VERT AU	Molex/Waldom Electronics Corp	WM26808- ND	Y	Y
17	1	LS1	BUZZER AUDIO PIEZO 25V SMD	CUI Inc	CMT-1603	Y	Y
18	1	P1	LCD FEMA Custom 60 Pin, 16 Commons, 28 Seg Lines	FEMA	593043-527	Y	Y
19	1	RT1	THERMISTOR NTC 10K OHM LEADED	BC Components	2381 640 66103	Y	Y
20	1	R1	RES 10.0K OHM 1/16W 1% 0603 SMD	Yageo Corpora- tion	RC0603FR- 0710KL	Y	Y
21	4	R23,R25,R5 2,R53	RES 100K OHM 1/16W 5% 0402 SMD	Panasonic - ECG	ERJ- 2GEJ104X	Y	Y
22	4	R14,R15,R1 6,R17	RES 560 OHM 1/16W 5% 0402 SMD	Yageo Corpora- tion	RC0402JR- 07560RL	Y	Y
23	1	R19	RES 4.7K OHM 1/10W 5% 0805 SMD	Panasonic - ECG	ERJ- 6GEYJ472V	Y	Y
24	3	R20,R39,R4 0	RES 10 OHM 1/16W 5% 0402 SMD	Yageo	RC0402JR- 0710RL	Y	Y
25	1	R22	RES 300K OHM 1/10W 5% 0402 SMD	Panasonic - ECG	ERJ- 2GEJ304X	Y	Y
26	2	R24,R51	RES 1.50K OHM 1/16W 1% 0402 SMD	Panasonic - ECG	ERJ- 2RKF1501X	Y	Y
27	2	R37,R38	RES ZERO OHM 1/16W 5% 0603 SMD	Panasonic - ECG	ERJ- 3GEY0R00V	Y	Y
28	3	R41,R57,R5 8	RES ZERO OHM 1/16W 0402 SMD	Panasonic - ECG	ERJ- 2GE0R00X	Y	Y
29	1	R42	RES 100 OHM 1/16W 5% 0402 SMD	Rohm	MCR01MZPJ 101	Y	Y
30	1	R45	RES 39K OHM 1/16W 5% 0402 SMD	Panasonic - ECG	ERJ- 2GEJ393X	Y	Y
31	1	R46	RES 62K OHM 1/10W 5% 0402 SMD	Panasonic - ECG	ERJ- 2GEJ623X	Y	Y
32	3	R49,R50,R5 9	RES 0.0 OHM 1/10W 5% 0805 SMD	Panasonic-ECG	ERJ- 6GEY0R00V	Y	Y

Item	Qty.	Reference	Part	Manufacturer	Mfrg. Part No.	RoHS	Sub
33	1	SW1	SWITCH SLIDE MINI SPDT PCMNT SLV	ITT Industries, C&K Div	1101M2S3C QE2	Y	Y
34	1	S1	LT SWITCH 6MM 100GF H=7MM TH	Panasonic - ECG	EVQ- PAC07K	Y	Y
35	3	TP3,TP4,TP 6	TEST POINT 43 HOLE 65 PLATED RED	Keystone Elec- tronics	5000	Y	Y
36	1	TP5	TEST POINT 43 HOLE 65 PLATED BLACK	Keystone Elec- tronics	5001	Y	Y
37	1	U1	PSoC3 Mixed-Signal Array	Cypress Semi- conductor	CY8C3866A XI-040	Y	Y
38	1	U12	IC Accelerometer Mem- sic 2-axis 3.3V-5V	Memsic	MXR2010A	Y	Y
39	1	U14	IC REG 5.0V 800MA LDO SOT-223	National Semi- conductor	LM1117MPX- 5.0	Y	Y
40	1	Y1	CRYSTAL 32.768 kHz CYL 12.5PF	Citizen America Corporation	CFS206 32.768KDZF- UB	Y	Y

Do Not Load

41	1	C5	CAP 10000PF 16V CERAMIC X7R 0402	Yageo America	04022R103K 7B20D	Y	Y
42	2	C9,C29	CAP .10UF 16V CERAMIC X7R 0603	Kemet	C0603C104J 4RACTU	Y	Y
43	2	C10,C28	CAP CER 22UF 10V 10% X5R 1210	Kemet	C1210C226K 8PACTU	Y	Y
44	2	C26,C27	CAP 0402 NO LOAD	NA	NA	Y	Y
45	1	C30	CAPACITOR TANT 22UF 10V 20% SMD	Kemet	T491A226M0 10AS	Y	Y
46	4	CSD1,CSD2 ,CSD3,CSD 4	CapSense Touch Element F	Manufacturing Process		Y	Y
47	1	D1	DIODE SCHOTTKY 40V 1A SOT23	Zetex	ZHCS1000T A	Y	Y
48	1	D12	DIODE SCHOTTKY 40V 1.5A SMA	Vishay IR	10MQ040NT RPBF	Y	Y
49	1	D10	Diode, Zener, 3W, 5.6V, SMB	ON Semiconduc- tor	1SMB5919B T3	Y	Y

Item	Qty.	Reference	Part	Manufacturer	Mfrg. Part No.	RoHS	Sub
50	1	J3	CONN USB MINI AB SMT RIGHT ANGLE	TYCO	1734035-2	Y	Y
51	1	L1	COIL PWR CHOKE 10UH 1A SMD	Panasonic - ECG	ELL- 6PM100M	Y	Y
52	1	L2	FERRITE CHIP BEAD 120 OHM SMD	TDK Corporation	MMZ1005S1 21C	Y	Y
53	2	BH1,BH2	CLIP BATTERY AA PC MNT	Keystone Elec- tronics	92	Y	Y
54	2	R11,R12	RES 22 OHM 1/16W 1% 0402 SMD	Panasonic - ECG	ERJ- 2RKF22R0X	Y	Y
55	1	R13	RES 100K OHM 1/16W 5% 0402 SMD	Panasonic - ECG	ERJ- 2GEJ104X	Y	Y
56	1	R44	RES 3.00K OHM 1/8W 1% 0805 SMD	Yageo America	RC0805FR- 073KL	Y	Y
57	2	R47,R48	RES NO LOAD 0805 SMD	NA	NA	Y	Y
58	1	R18	RES NO LOAD 0603 SMD	NA	NA	Y	Y
59	4	R54,R55,R6 0,R61	RES NO LOAD 0402 SMD	NA	NA	Y	Y
60	1	R56	RES ZERO OHM 1/16W 0402 SMD	Panasonic - ECG	ERJ- 2GE0R00X	Y	Y
61	1	TP1	TEST POINT 43 HOLE 65 PLATED RED	Keystone Elec- tronics	5000	Y	Y
62	1	TP2	TEST POINT 43 HOLE 65 PLATED BLACK	Keystone Elec- tronics	5001	Y	Y
Install On Bottom of PCB Near Rounded Corners As Noted On SASSY assembly drawing.							
63	4	n/a	BUMPER CLEAR.370X.19" CYLIN- DER	Richco Plastic Co	RBS-35	Y	Y

A.5 PCB Layout and Silkscreen

