

SMD ■ B 69-23BUMD/TR8

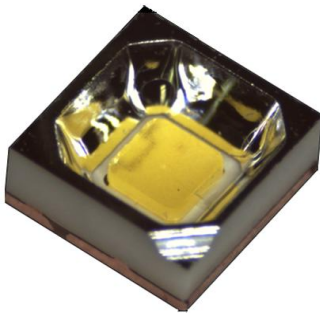

Features

- Super luminosity white LED.
- Built in 3 LED chips.
- Soldering methods: Reflow soldering.
- High performance.
- Package in 12mm tape on 7" diameter reel.
- Pb-free.
- The product itself will remain within RoHS compliant version.

Description

- The 69-23B SMD LED is much smaller than lead frame type components, thus enable smaller board size, higher packing density, reduced storage space and finally smaller equipment to be obtained.
- Besides, lightweight makes them ideal for miniature applications. etc.

Applications

- Amusement equipment.
- Information boards.
- Flashlight for digital camera of cellular phone.
- Lighting for small size device.

Device Selection Guide

Chip Materials	Emitted Color	Resin Color
InGaN	White	Yellow Diffused

Absolute Maximum Ratings (Ta=25°C)

Parameter	Symbol	Rating	Unit
Reverse Voltage	V_R	5	V
Forward Current	I_F	30	mA
Peak Forward Current (Duty 1/10 @1KHz)	I_{FP}	100	mA
Power Dissipation	P_d	111	mW
Operating Temperature	T_{opr}	-40 ~ +85	°C
Storage Temperature	T_{stg}	-40 ~ +90	°C
Electrostatic Discharge	ESD_{HBM}	1000	V
Soldering Temperature	T_{sol}	Reflow Soldering : 260 °C for 10 sec. Hand Soldering : 350 °C for 3 sec.	

* The value are base d on the 1-die performance.

Electro-Optical Characteristics (Ta=25°C)

Parameter	Symbol	Min.	Typ.	Max.	Unit	Condition
Luminous Intensity*1	I _v	9100	-----	18000	mcd	I _F =20mA*2
Viewing Angle*1	2θ _{1/2}	-----	60	-----	deg	I _F =20mA*2
Forward Voltage*2	V _F	2.7	3.3	3.7	V	I _F =20mA*2
Reverse Current	I _R	-----	-----	50	μA	V _R =5V*2

*1 When 3 LED dies are operated simultaneously.

*2 For each die.

Note:

1. The products are sensitive to static electricity and care must be fully taken when handling products.
2. Tolerance of Luminous Intensity ±11%

Bin Range of Luminous Intensity

Bin Code	Min.	Max.	Unit	Condition
Z12	9100	11500	mcd	I _F =20mA*2
Z21	11500	14400		
Z22	14400	18000		

Chromaticity Coordinates Specifications for Bin Grading

I_F=20mA*2

Rank	CCT	CIE_X	CIE_Y
V4	5000K~5650K	0.329	0.357
		0.329	0.369
		0.348	0.385
		0.347	0.372
V5		0.329	0.345
		0.329	0.357
		0.347	0.372
		0.346	0.359
V6		0.329	0.331
		0.329	0.345
		0.346	0.359
		0.344	0.344
V7	0.329	0.331	
	0.344	0.344	
	0.343	0.331	
	0.329	0.32	

Rank	CCT	CIE_X	CIE_Y
W4	5650K~6300K	0.329	0.369
		0.329	0.357
		0.315	0.344
		0.314	0.355
W5		0.329	0.345
		0.316	0.333
		0.315	0.344
		0.329	0.357
W6		0.329	0.345
		0.329	0.331
		0.317	0.32
		0.316	0.333
W7	0.329	0.331	
	0.329	0.32	
	0.318	0.31	
	0.317	0.32	
W8	0.329	0.321	
	0.329	0.31	
	0.319	0.3	
	0.318	0.31	

Rank	CCT	CIE_X	CIE_Y
X4	6300K~7000K	0.301	0.342
		0.314	0.355
		0.315	0.344
		0.303	0.333
		0.305	0.322
X5	6300K~7000K	0.303	0.333
		0.315	0.344
		0.316	0.333
		0.308	0.311
		0.305	0.322
X6	6300K~7000K	0.316	0.333
		0.317	0.320
		0.308	0.311
		0.317	0.320
		0.319	0.300
X7	6300K~7000K	0.311	0.293

CIE Chromaticity Diagram

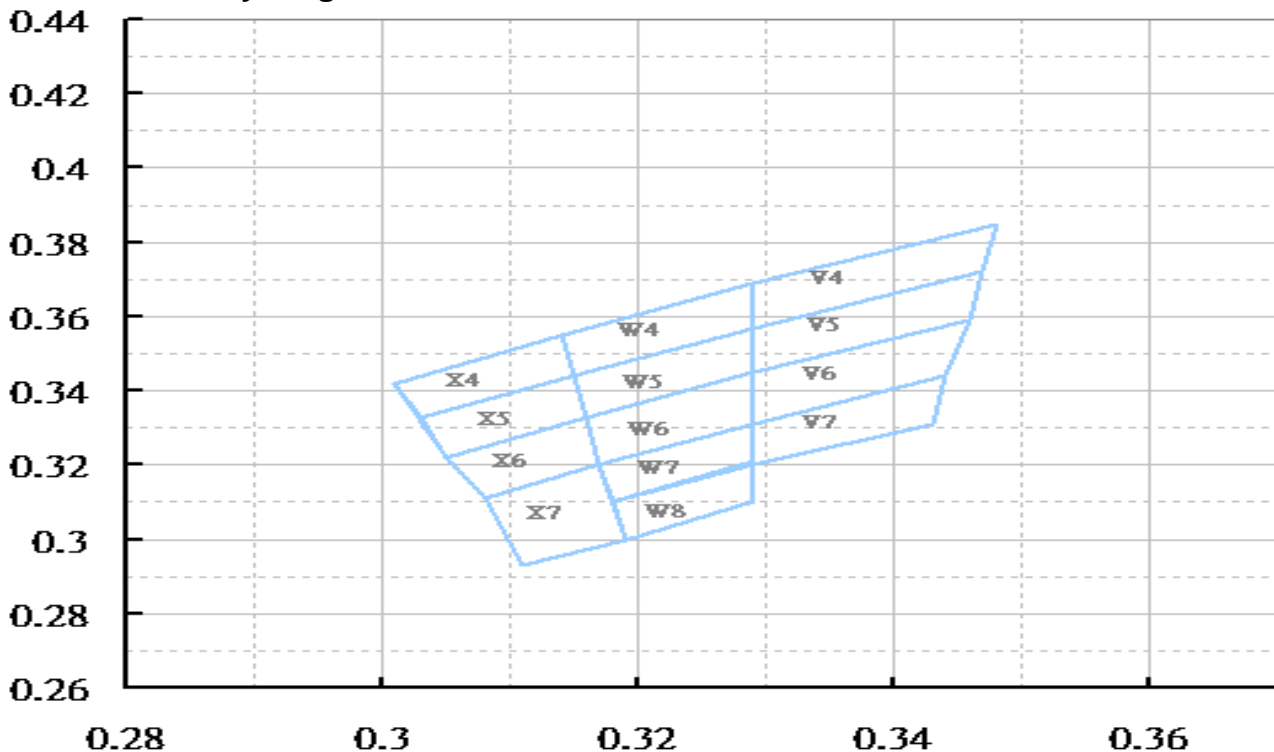

*1 When 3 LED dies are operated simultaneously.

*2 For each die.

*3 The C.I.E. 1931 chromaticity diagram (Tolerance ± 0.01).

Note: 1. The products are sensitive to static electricity and care must be fully taken when handling products.

2. Tolerance of Luminous Intensity $\pm 11\%$

Typical Electro-Optical Characteristics Curves

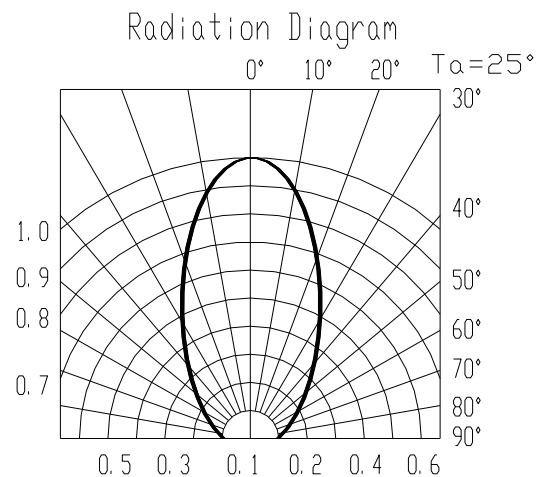
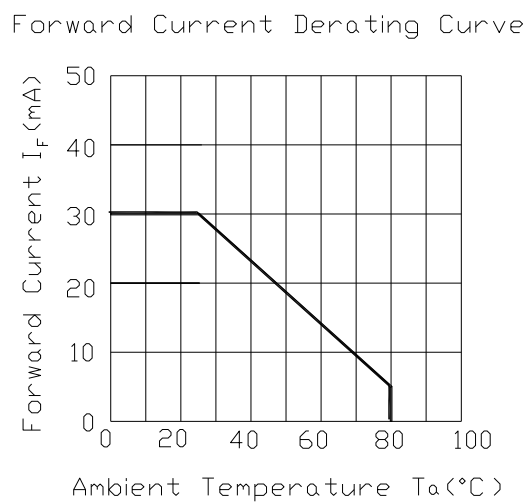
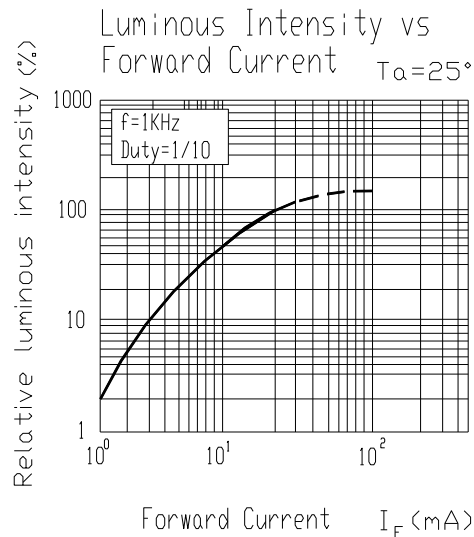
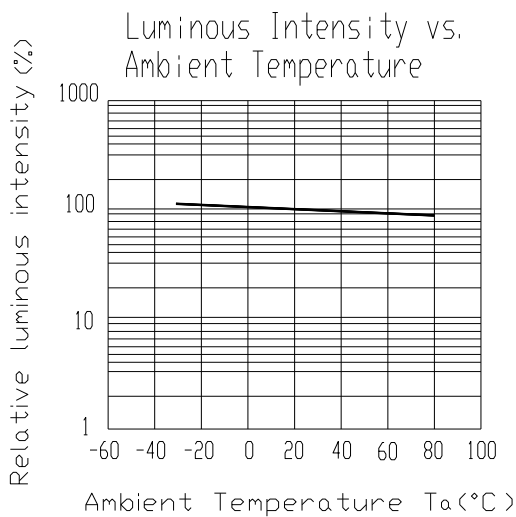
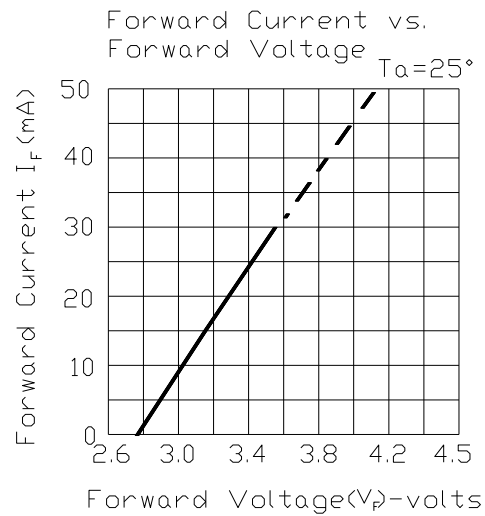
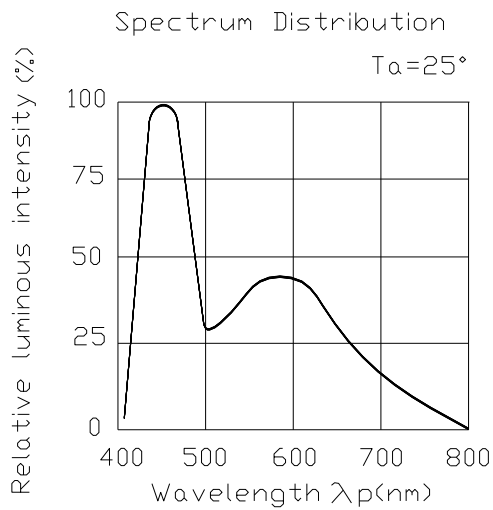

Moisture Resistant Packing Materials

Label Explanation

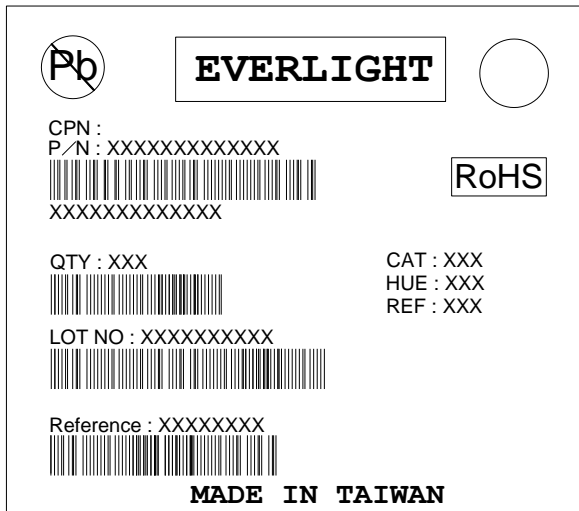

- CPN: Customer's Product Number
- P/N: Product Number
- QTY: Packing Quantity
- CAT: Luminous Intensity Rank
- HUE: Chromaticity Coordinates & Dom. Wavelength Rank
- REF: Forward Voltage Rank
- LOT No: Lot Number

Reel Dimensions

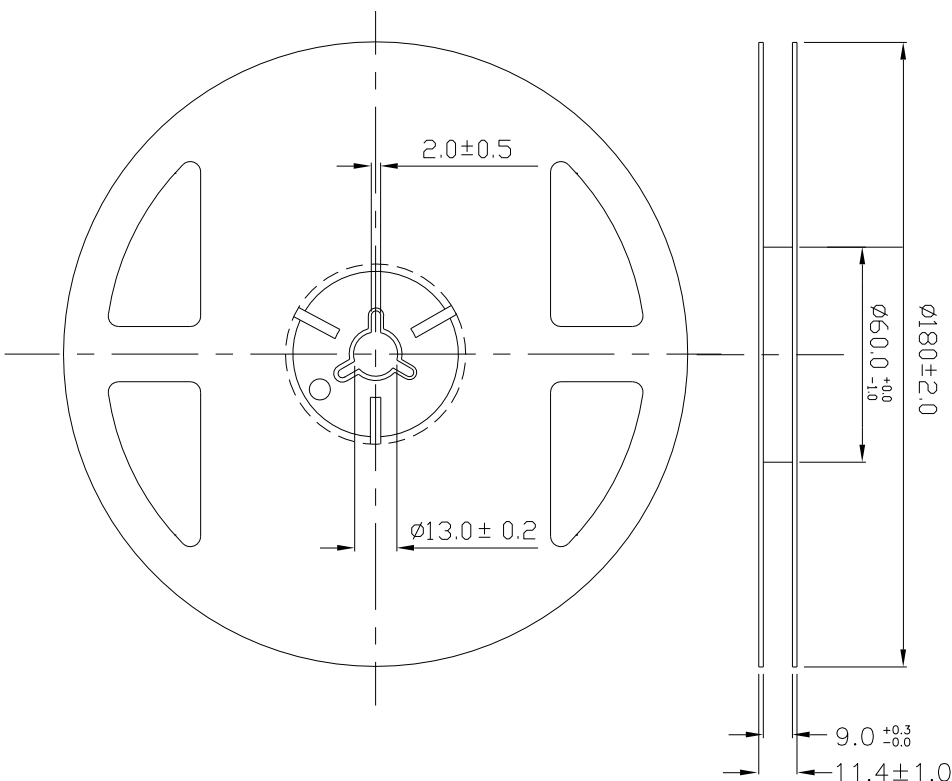

Note: The tolerances unless mentioned is $\pm 0.1\text{mm}$, Unit = mm

Carrier Tape Dimensions: Loaded quantity 3000 PCS per reel

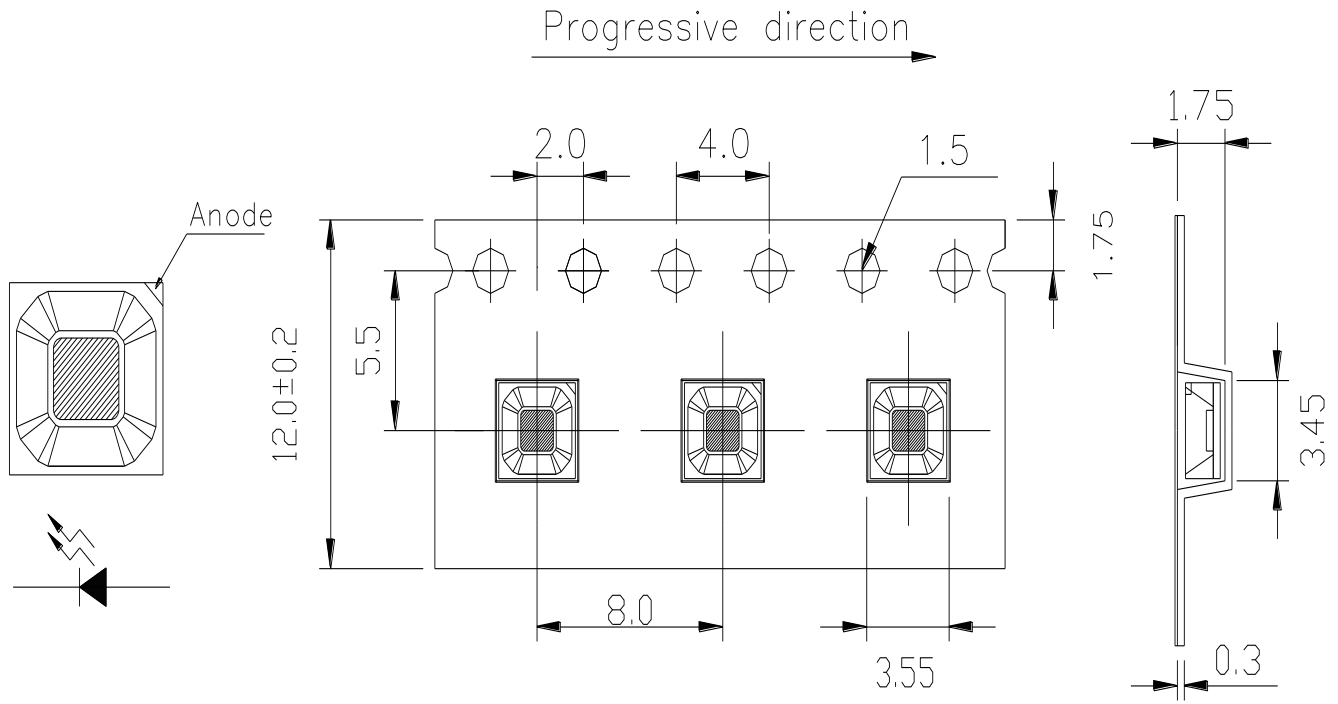

Note: The tolerances unless mentioned is $\pm 0.1\text{mm}$,Unit = mm

Moisture Resistant Packaging

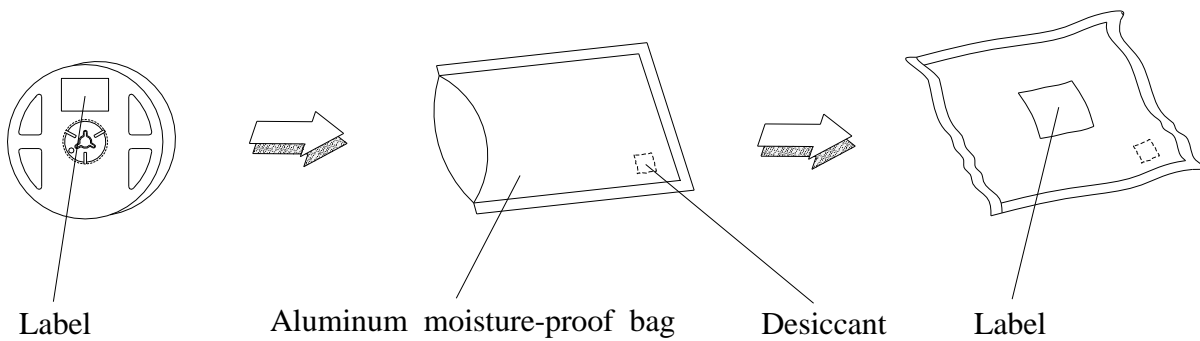

Precautions For Use

1. Over-current-proof

Customer must apply resistors for protection, otherwise slight voltage shift will cause big current change (Burn out will happen).

2. Storage

2.1 Do not open moisture proof bag before the products are ready to use.

2.2 Before opening the package: The LEDs should be kept at 30°C or less and 90%RH or less.

2.3 After opening the package: The LED's floor life is 1 year under 30°C or less and 60% RH or less.

If unused LEDs remain, it should be stored in moisture proof packages.

2.4 If the moisture absorbent material (silica gel) has faded away or the LEDs have exceeded the storage time, baking treatment should be performed using the following conditions.

Baking treatment : 60±5°C for 24 hours.

3. Soldering Condition

3.1 Pb-free solder temperature profile

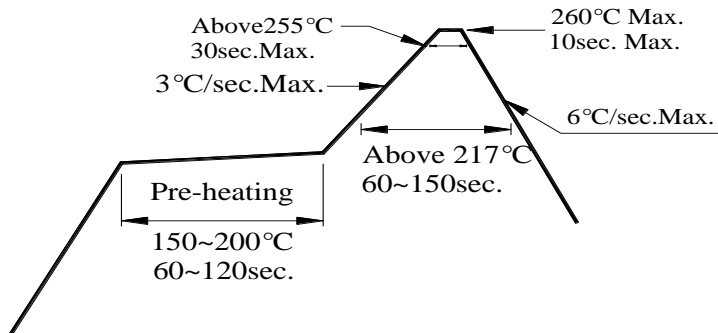

3.2 Reflow soldering should not be done more than two times.

3.3 When soldering, do not put stress on the LEDs during heating.

3.4 After soldering, do not warp the circuit board.

4. Soldering Iron

Each terminal is to go to the tip of soldering iron temperature less than 350°C for 3 seconds within once in less than the soldering iron capacity 25W. Leave two seconds and more intervals, and do soldering of each terminal. Be careful because the damage of the product is often started at the time of the hand solder.

5. Repairing

Repair should not be done after the LEDs have been soldered. When repairing is unavoidable, a double-head soldering iron should be used (as below figure). It should be confirmed beforehand whether the characteristics of the LEDs will or will not be damaged by repairing.

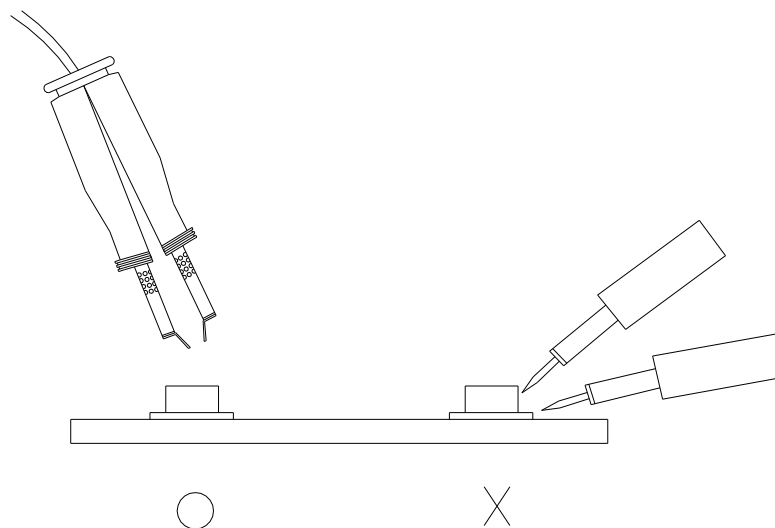

Application Restrictions

High reliability applications such as military/aerospace, automotive safety/security systems, and medical equipment may require different product. If you have any concerns, please contact Everlight before using this product in your application. This specification guarantees the quality and performance of the product as an individual component. Do not use this product beyond the specification described in this document.