

ISL29028, ISL29030, ISL29031 Evaluation Hardware/Software Manual

Ambient Light Sensor Products

<http://www.intersil.com/lightsensor/>

ISL29028 - Low Power ALS and PROX Sensor with I²C & Address Select Pin

ISL29030 - Low Power ALS and PROX Sensor with I²C & Analog Out

ISL29031 - Standalone Low Power PROX Sensor

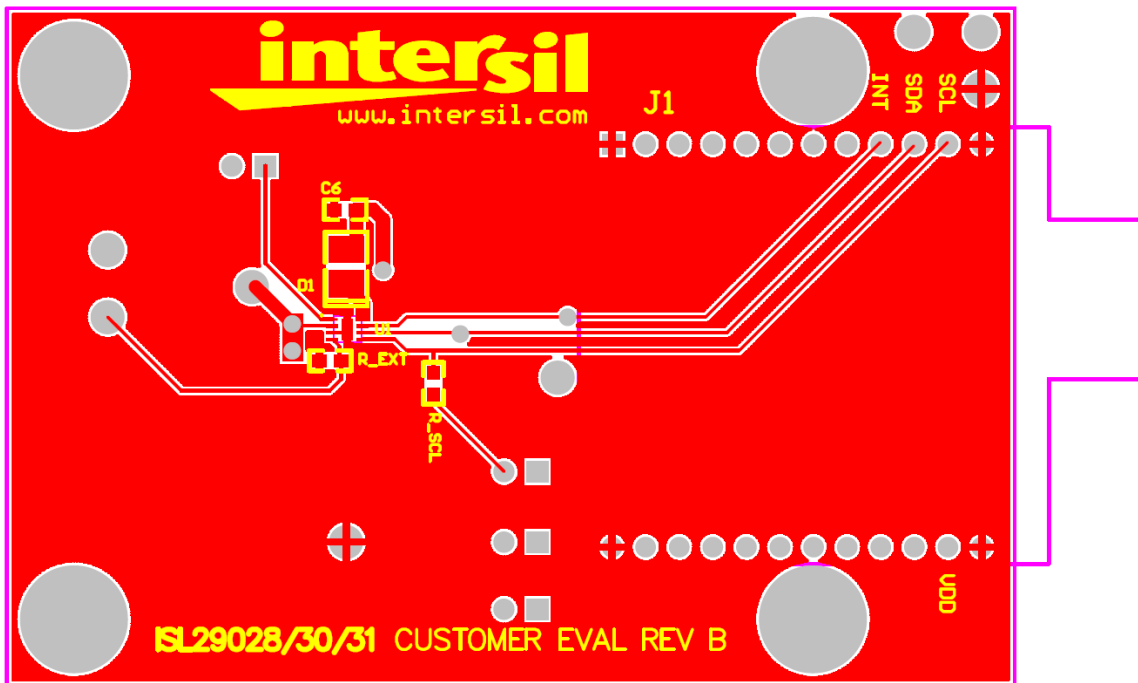

FIGURE 1. REV B EVALUATION BOARD LAYOUT

Table of Contents

Evaluation Kit Contents 3

Software..... 3

- Installing the Software..... 3
- Running the Program..... 4
- Main Window..... 4
 - Register 0x01 – Configure Modes..... 5
 - Register 0x02 – Interrupt Behavior 5
 - Registers 0x03 to 0x07 – Interrupt Thresholds 5
 - External Interrupt and Interrupt LEDs 5
 - Complete Register Listing 5
 - Real-Time Data Acquisition Graph..... 5
 - ADC Resolution and Graph Rescaling 5
 - Saving Measurements to File..... 5

Hardware 6

- Schematic and Layout..... 6
- Connecting the PCB to PC..... 6
- Jumpers on PCB..... 6
 - JP_PIN1 6
 - JP_IC..... 6
 - JP_MISC..... 6
 - JP_IRLED 6

Troubleshooting 6

Schematic..... 7

PCB Layout 8

Evaluation Kit Contents

The evaluation kit consists of the hardware, software, and documentation listed below.

1. Evaluation PCB
2. PDF of board schematic (online)
3. PDF of board layout (online)
4. Evaluation Software Installer (online)
5. Evaluation Board manual (online)
6. IC Data sheets (online)

The software and documentation can be found at the following link:

<http://intersil.com/products/deviceinfo.asp?pn=ISL29028#data>

Software

Installing the Software

From the link in the previous section, download and run *Intersil_ISL29028-30-40_Installer.exe*. The user will be greeted by the screen shown in Figure 2. Continue through the installer and read the instructions. The PC and PCB should *not* be connected via USB until after the installation has satisfactorily completed.

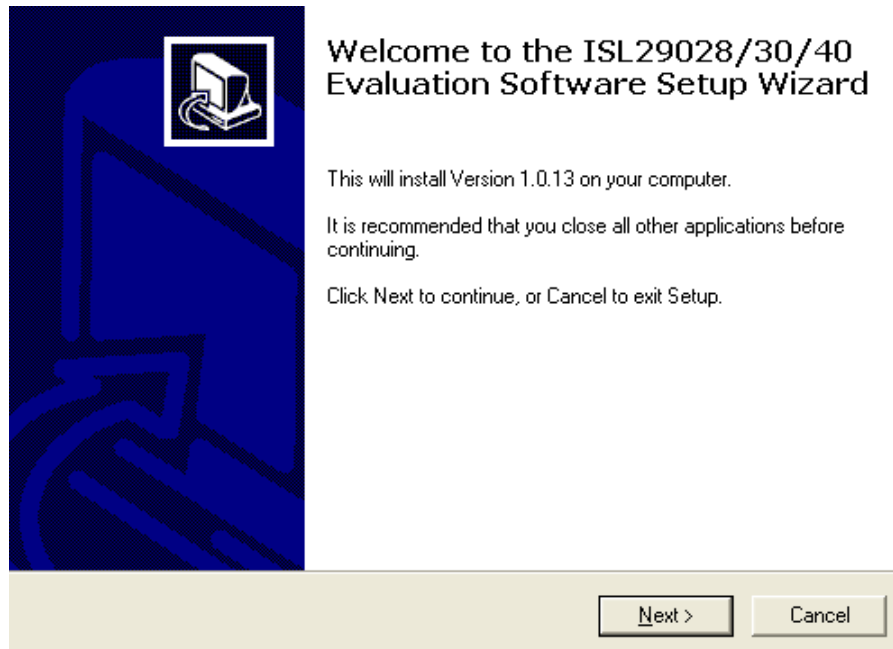

FIGURE 2. SOFTWARE INSTALLER START-UP SCREEN

Application Note 1540

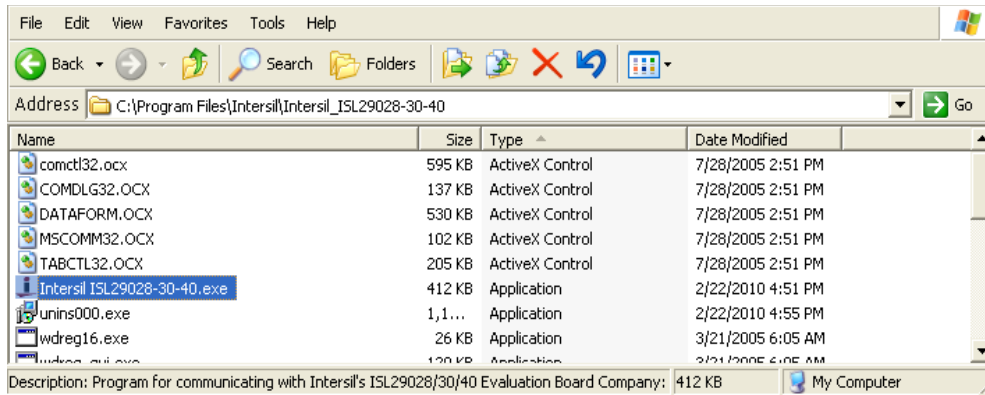

FIGURE 3. LOCATION OF EXECUTABLE ON USER'S HARD DRIVE

Running the Program

If the user has selected the default installation path, the software will install in the following folder: *C:\Program Files\Intersil\Intersil_ISL29028-30-40* as seen in Figure 3.

Double-click the highlighted executable shown in Figure 3 to start the evaluation software. A shortcut to this file is also provided via the Windows Start Menu under *All Programs → Intersil → Intersil_ISL29028-30-40*.

Connect the PC to the evaluation PCB via a USB cable. When this connection is made, the "Attached" box displayed in Figure 4 should turn green.

The ISL29028 has a selectable I²C address (see pin ADDR0). By changing the input logic signal (via jumper JP_PIN1), the I²C address can be set to either 0x88 or 0x8A (see the PCB schematic/IC data sheet for more information.) This board is shipped with jumper JP_PIN1 removed, so by default the part will respond to I²C address 0x88.

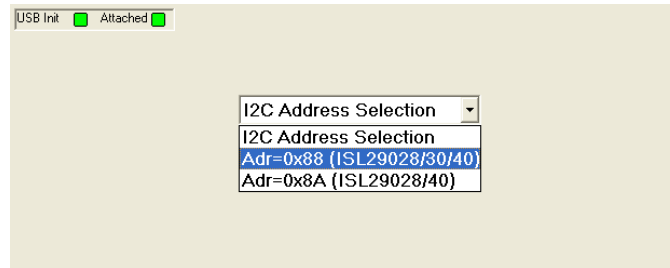

FIGURE 4. SOFTWARE START-UP SCREEN

Main Window

The main evaluation software window can be seen in Figure 5.

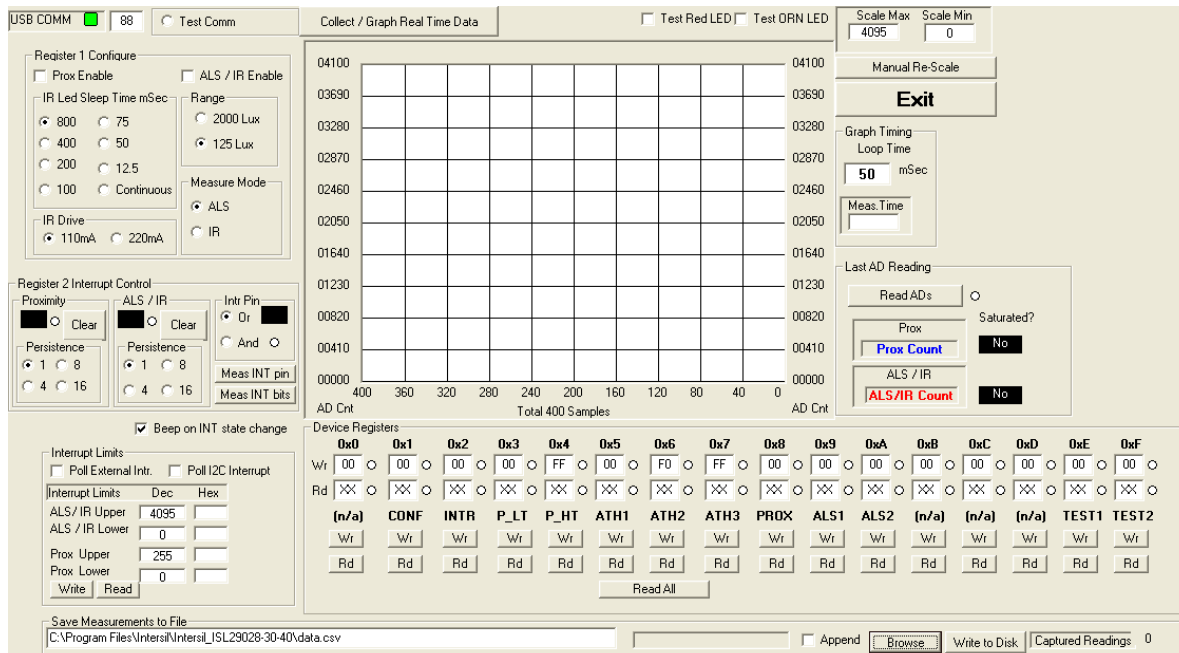

FIGURE 5. SOFTWARE MAIN SCREEN

Application Note 1540

If the user desires to change the I²C address the GUI communicates with, see the upper-left box containing "88" in Figure 5. Change the number as desired and click the "Test Comm" box to test for a valid communication link between the PC and Light Sensor at the specified I²C address.

REGISTER 0X01 – CONFIGURE MODES

IC register 0x01 controls the range and modes of the part. "Sleep time", "Range" and "Measure Mode" bits are explained in detail in the data sheet. All control bits *not* related to the interrupt function are located in this register.

REGISTER 0X02 – INTERRUPT BEHAVIOR

IC register 0x02 contains the interrupt flags and controls the interrupt modes. Interrupt persistence, and AND/OR (see bit 0) functionality is contained in this register.

REGISTERS 0X03 TO 0X07 – INTERRUPT THRESHOLDS

The PROX interrupt thresholds and ALS thresholds are stored in registers 0x03 to 0x07. They can be edited by writing values to the "Interrupt Limits" box and clicking "write". See the IC data sheet for more information on interrupt limits.

EXTERNAL INTERRUPT AND INTERRUPT LEDS

To poll the status of the hardware *INT* pin, select the "Poll External Intr" checkbox and the on-PCB microcontroller will continuously check the logic state of the *INT* line. To poll the status of *ALS_FLAG* and *PROX_FLAG* interrupt bits (in register 0x02), select the "Poll I²C Interrupt" checkbox - the GUI will perform an I²C read and then instruct the microcontroller to turn D3/D4 on or off depending on the state of *ALS_FLAG* and *PROX_FLAG*.

COMPLETE REGISTER LISTING

The "Device Registers" box at the bottom of the GUI displays a complete listing of all registers in hex format and should automatically update based on the options selected by the user. Users can individually write to or read from these registers using the "Wr"/"Rd" buttons.

REAL-TIME DATA ACQUISITION GRAPH

To graphically display the results of ALS and proximity conversions, first click the checkboxes "ALS / IR Enable" and "Prox Enable" and select the mode of operation by the radio buttons in the "Register 1 Configure" area. After this register is configured, click the "Collect Data" button shown in the upper-left of Figure 6. Both ALS and Proximity conversions can happen (and are displayed) at once because the ISL29028 architecture has two concurrent ADCs.

ADC RESOLUTION AND GRAPH RESCALING

Because the ALS conversions are inherently 12-bit ($2^{12}-1 = 4095$ count maximum), and the proximity conversions are inherently 8-bit ($2^8-1 = 255$ count maximum), the graph may require rescaling to view both results on the same curve at once. To set a new maximum and minimum graphical scale, change the numbers in the "Scale Max" and "Scale Min" boxes, then click "Manual Re-Scale".

SAVING MEASUREMENTS TO FILE

To save a series of ALS and PROX measurements to disk, see the "Save Measurements to File" box at the very bottom of the GUI. The user may click "Browse" to select a filename/filepath and click "Write to Disk" to write the currently graphed data to disk.

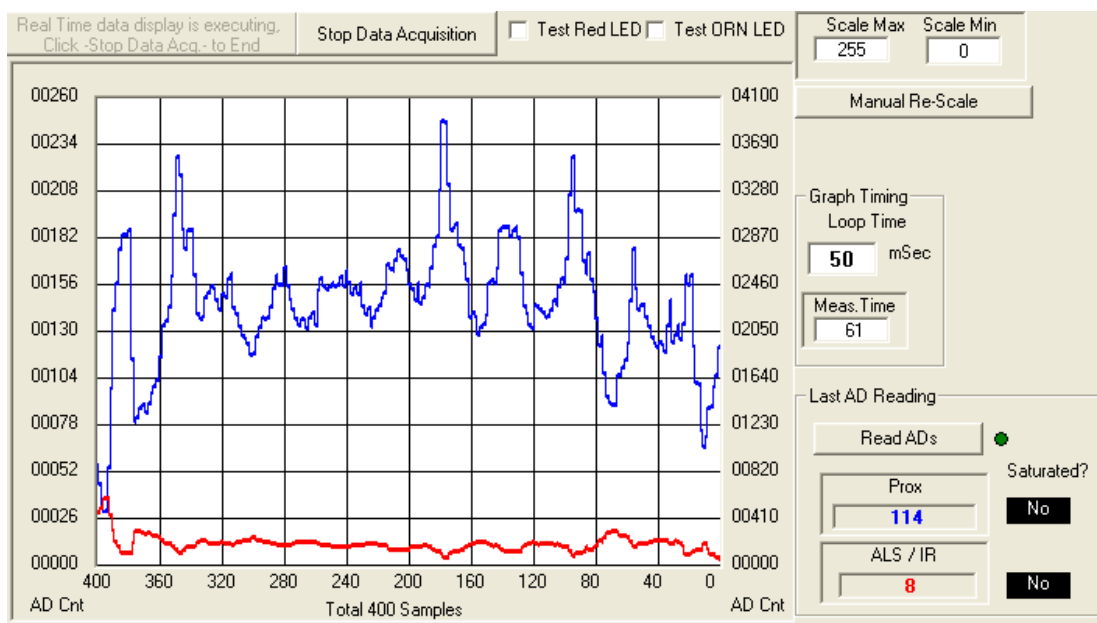

FIGURE 6. ALS (RED LINE) AND PROX (BLUE LINE) DATA CONVERSIONS RESULTS

Hardware

Schematic and Layout

The PCB schematic and Layout are contained on the CD-ROM included with this evaluation kit (also see Figures 7 through 10). If lost, contact the local Intersil sales/FAE team.

(<http://www.intersil.com/cda/Support/contacts/>)

Connecting the PCB to PC

Insert the USB-B plug into the Intersil evaluation PCB, and the USB-A plug into the user's PC. As seen in Figure 4, the status of the PC<-->PCB communication link is displayed in the colored box next to "Attached".

Jumpers on PCB

The "rev B" evaluation board has 4 jumpers which control various aspects of the part. By default, the jumpers *JP_IC*, *JP_MISC*, and *JP_IRLED* need not be connected due to the 0Ω resistors *R6*, *R7*, and *R8* which connect to a 3.3V rail. If the user desires to test part performance at voltages other than $V_{DD} = V_{IR-LED} = V_{I2C} = 3.3V$: unsolder these resistors, use the installed test points, and power any of the 3 rails as desired.

TABLE 1. JUMPER OVERVIEW

DESIGNATOR	FUNCTION
JP_PIN1	ISL29028: Changes I ² C address ISL29030: Leave open (see below) ISL29031: Enables/disables IC
JP_IC	Connects 3.3V rail to VDD
JP_MISC	Connects 3.3V rail I ² C pull-up, INT, PIN1
JP_IRLED	Connects 3.3V rail to the IR-LED D1

JP_PIN1

The jumper *JP_PIN1* is connected to pin 1 of the ODFN and should be **disconnected for ISL29030** usage, **connected for ISL29031** usage, and **will work in either state for the ISL29028**. The ISL29030 has a current source on pin 1. The ISL29031 has an ENABLE line tied to pin 1. The ISL29028 has an I²C address select line tied to pin 1.

JP_IC

JP_IC connects directly to *VDD*.

JP_MISC

The "miscellaneous" power rail supplies the I²C pull-up voltage, the interrupt line, and the LEDs *D3* and *D4*.

JP_IRLED

JP_IRLED connects directly to the anode of the IRLED *D1*.

Troubleshooting

Clicking the "test communication" button in the upper-left of the main window (see Figure 5) is the most useful method of verifying that a communication link is still active.

Also recall that since this is an optoelectrical part with a clear package, performance may be sensitive to aggressive scratching or damaging.

For other questions, comments, and feedback, contact the local Intersil FAE/Sales team.

(<http://www.intersil.com/cda/Support/contacts/>)

Schematic

JUMPER "JP_PIN1" EXPLANATION:
 ISL29028 - "PIN1" = ADDR0 / (jumper changes device I2C address)
 ISL29030 - "PIN1" = I_ALS / (analog current output pin, so leave jumper off)
 ISL29031 - "PIN1" = EN / (jumper enables-disables IC)

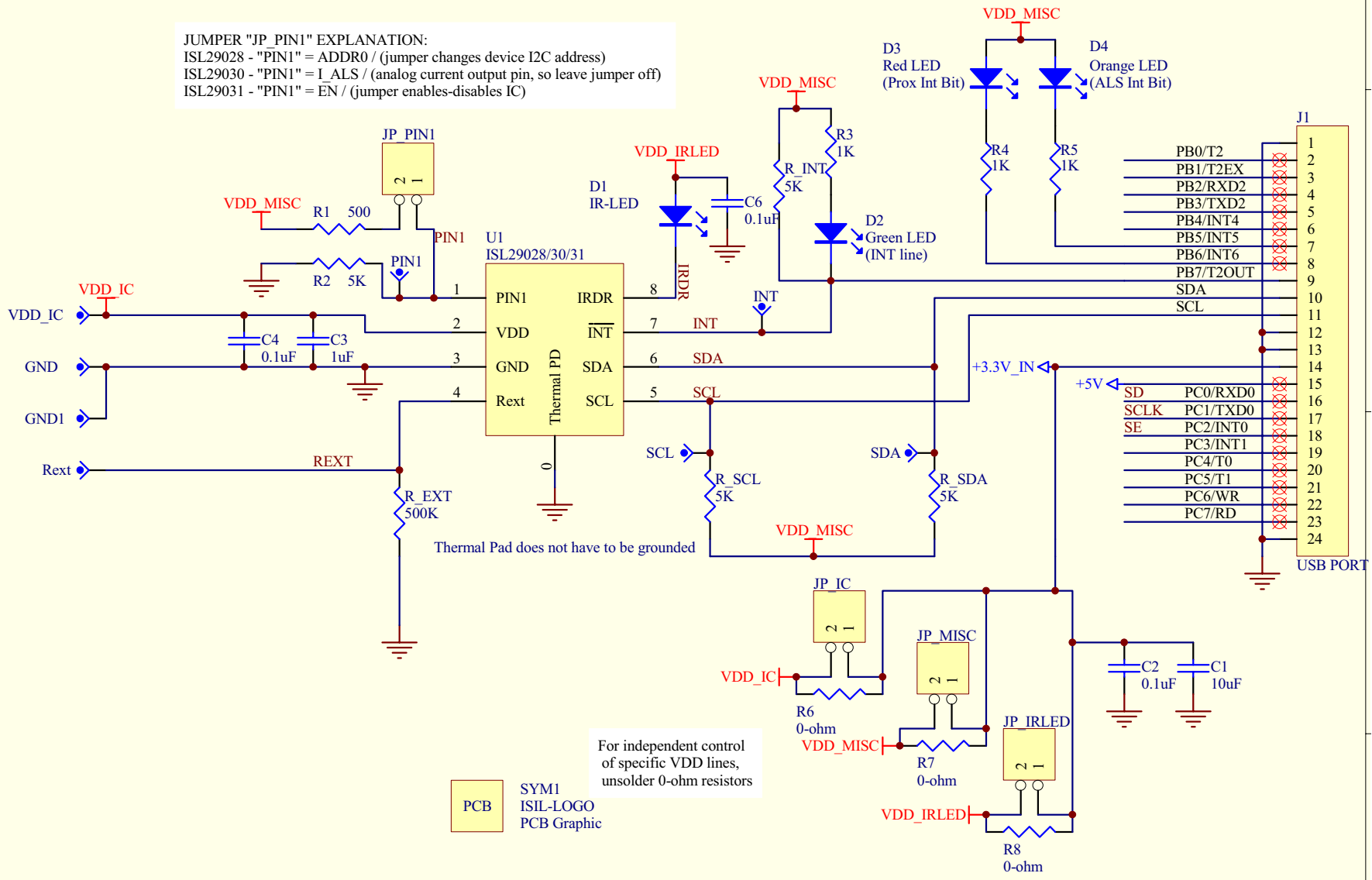
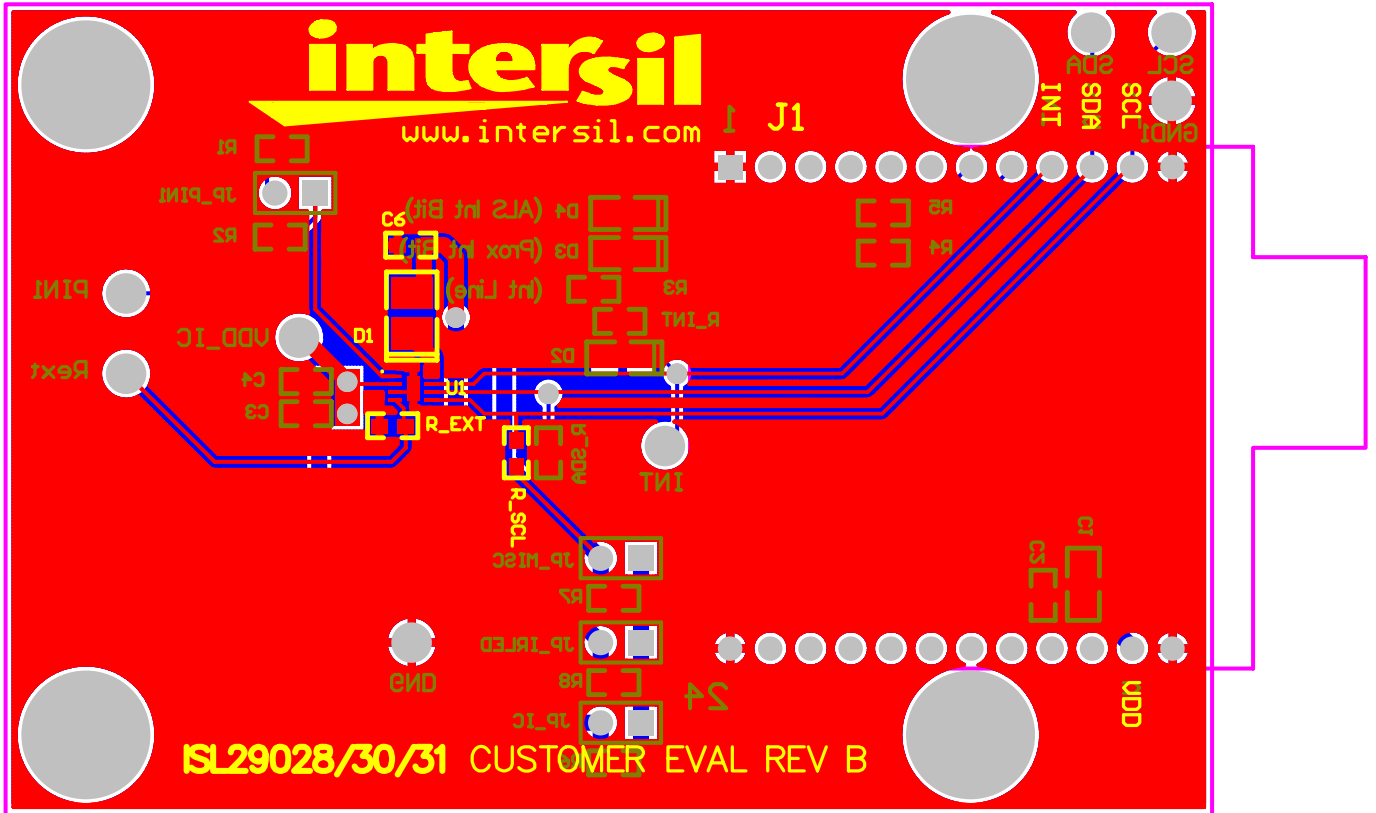

FIGURE 7.

PCB Layout



Top Overlay Keep Out Layer
 Top Layer Mechanical Layer 1
 Multi Layer
 Bottom Layer
 Bottom Overlay

FIGURE 8. TOP AND BOTTOM LAYERS

PCB Layout (Continued)

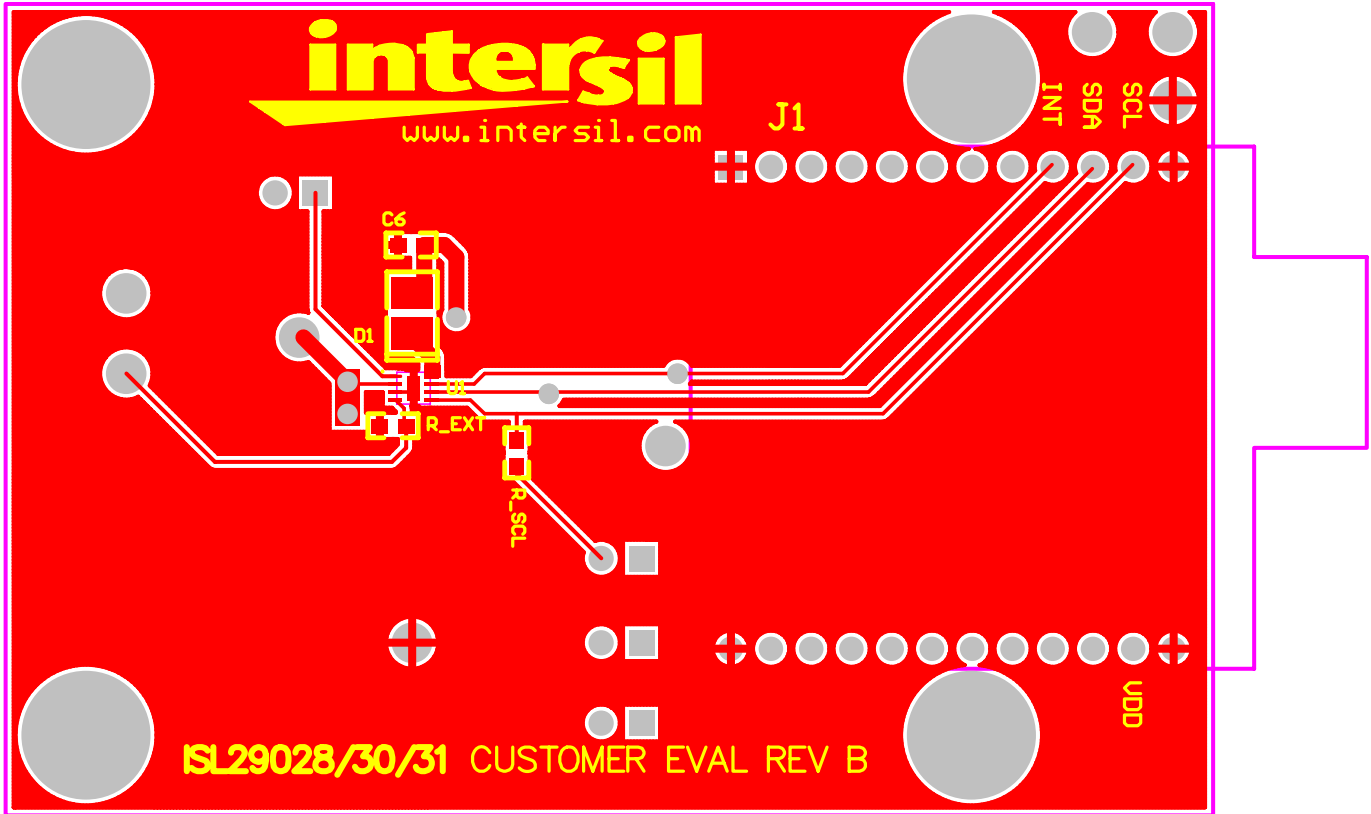

Top Overlay Keep Out Layer
Top Layer Mechanical Layer 1
Multi Layer

FIGURE 9. TOP LAYER

PCB Layout (Continued)

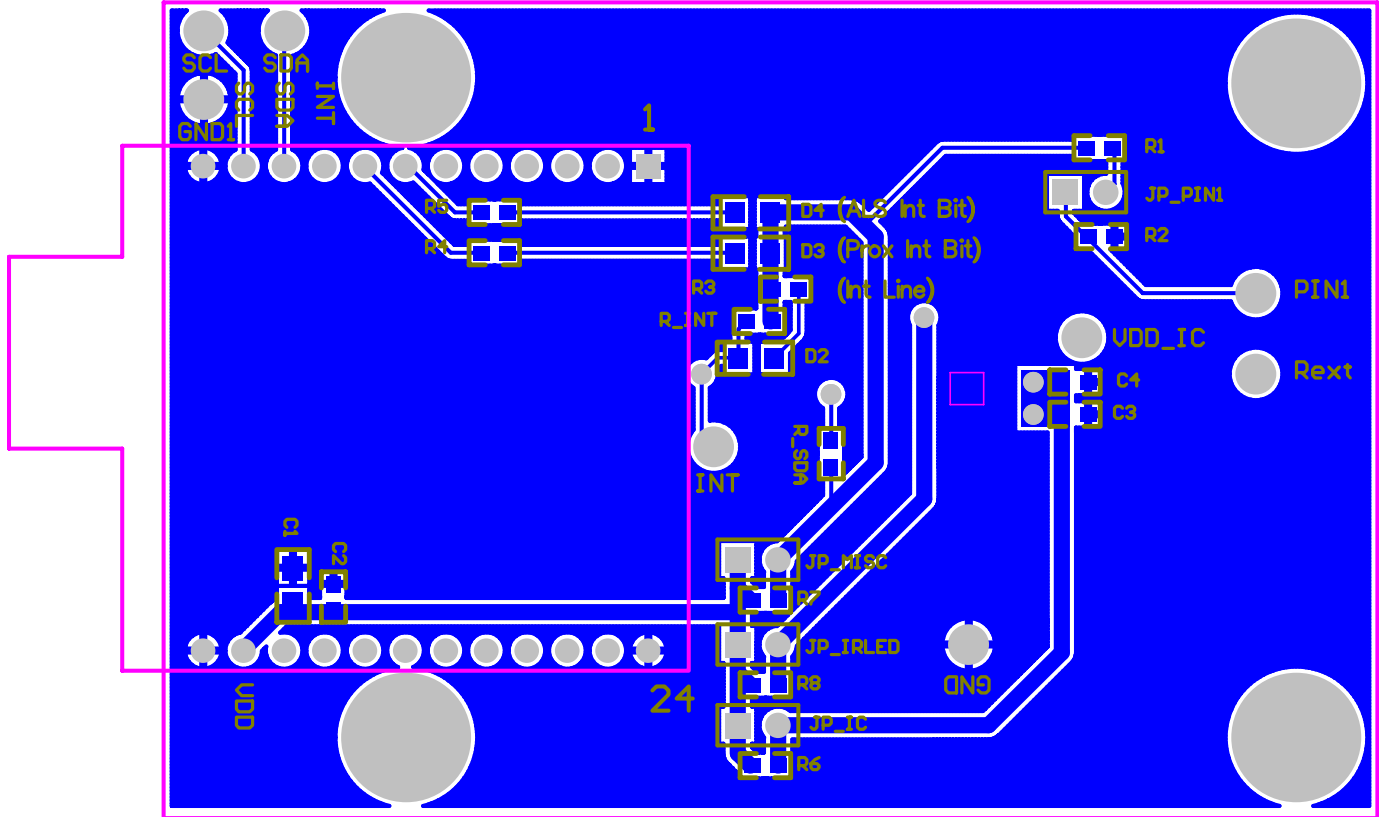

Keep Out Layer
Mechanical Layer 1

Multi Layer
Bottom Layer
Bottom Overlay

FIGURE 10. BOTTOM LAYER

Intersil Corporation reserves the right to make changes in circuit design, software and/or specifications at any time without notice. Accordingly, the reader is cautioned to verify that the Application Note or Technical Brief is current before proceeding.