

# Table of Specifications

## Midi-Contactors



Frame size	
Type	Terminal type
Number of poles	
Rated operational voltage, Ue	
Rated insulation voltage, Ui	
Rated frequency	
Rated impulse withstand voltage, Uimp	
Maximum operating rate in operating cycles per hour(AC3)	
Durability	Mechanical
	Electrical
Current and power	AC-1, Thermal current A
	AC-3 200/240V kW
	380/440V kW
	500/550V kW
	690V kW
UL rating (50/60Hz)	Continuous current A
	Single phase 110~120V HP
	220~240V HP
	200~208V HP
	Three phase 220~240V HP
	440~480V HP
Size and weight	NEMA size
	Weight kg
Size and weight	Size(W × H × D) mm
	Weight kg
Auxiliary(standard)	Side mount
	Front mount



22AF			
CC9	CC12	CC18	CC22
Screw Only			
3pole			
690V			
690V			
50/60Hz			
6kV			
1800 operations per hour			
15 mil. operations			
2.5 mil. operations			
25	25	32	40
2.5	3.5	4.5	5.5
11	13	18	22
4	5.5	7.5	11
9	12	18	22
4	7.5	7.5	15
7	12	13	20
4	7.5	7.5	15
6	9	9	18
25	25	40	40
0.5	0.75	1	2
1.5	2	3	3
2	3	5	7.5
3	5	7.5	10
5	7.5	10	15
7.5	10	15	20
00	00	0	1
0.34			
45 × 73.5 × 86			
0.51			
45 × 73.5 × 117.7			
GUA1, GUA2, GUA4			
GUA-1			
GUA-2, GUA-4			

40AF	
CC32	CC40
Screw Only	
3pole	
690V	
1000V	
50/60Hz	
8kV	
1800 operations per hour	
12 mil. operations	
2 mil. operations	
50	60
7.5	11
32	40
15	18.5
32	40
18.5	22
28	32
18.5	22
20	23
50	60
2	3
5	7.5
7.5	15
10	15
20	30
25	30
1	1
0.55	
69 × 83 × 93	
0.77	
69 × 83 × 120	
GUA-1	
GUA-2, GUA-4	

Note) Minimum conduct current of Auxiliary contactor is DC 17V 5mA.

## GT Type Thermal Overload Relays



Type	Screws clamp terminals
Rated operational voltage, Ue	
Rated insulation voltage, Ui	
Rated impulse withstand voltage, Uimp	
Trip class	
Setting range	
Size and weight	Weight kg
	Size(W × H × D) mm



GT32
690V
690V
6kV
10A, 20
0.1~40A
0.17
45 × 75 × 90

GT32
690V
690V
6kV
10A, 20
0.1~40A
0.17
45 × 75 × 90

# Table of Specifications



65AF	
CC50	CC65
Screw or Lug	
3pole	
690V	
1000V	
50/60Hz	
8kV	
1800 operations per hour	
12 mil. operations	
2 mil. operations	
70	100
15	18,5
55	65
22	30
50	65
30	33
43	60
30	33
28	35
70	100
3	5
10	15
20	25
25	30
40	50
50	60
2	2
1.05	
79 × 106 × 122	
1.3	
79 × 106 × 149	

GUA-1	
GUA-2, GUA-4	



GT63
•
690V
690V
6kV
10A, 20
4~65A
0.31/0.33
55 × 81 × 100



100AF		
CC75	CC85	CC100
Screw or Lug		
3pole		
690V		
1000V		
50/60Hz		
8kV		
1800 operations per hour		
12 mil. operations		
2 mil. operations		
110	135	160
22	25	30
75	85	105
37	45	55
75	85	105
37	45	55
64	75	85
37	45	45
42	45	65
110	135	160
5	7.5	10
15	15	20
25	30	30
30	40	40
50	60	75
60	75	75
2	3	3
1.93		
94 × 140 × 137		
2.8		
94 × 140 × 174		

GUA-1		
GUA-2, GUA-4		



GT95
•
690V
690V
6kV
10A, 20
7~100A
0.48/0.5
70 × 97 × 110

# Table of Specifications

## 3 - Pole Power Contactors



Frame size				150AF		225AF	
Type	Terminal type			<b>CC130</b>	<b>CC150</b>	<b>CC185</b>	<b>CC225</b>
Number of poles				Screw or Lug		Screw Only	
Rated operational voltage, Ue				3pole		3pole	
Rated insulation voltage, Ui				690V		690V	
Rated frequency				1000V		1000V	
Rated impulse withstand voltage, Uimp				50/60Hz		50/60Hz	
Maximum operating rate in operating cycles per hour(AC3)				8kV		8kV	
Durability	Mechanical			1200 operations per hour		1200 operations per hour	
	Electrical			5 mil. operations		5 mil. operations	
Current and power	AC-1, Thermal current	A		160	210	230	275
	AC-3	200/240V	kW	37	45	55	75
		380/440V	kW	130	150	185	225
			A	60	75	90	132
		500/550V	kW	130	150	185	225
			A	60	70	110	132
		690V	kW	90	100	180	200
			A	55	55	110	140
			A	60	60	120	150
UL rating (50/60Hz)	Continuous current	A		160	210	230	275
	Single phase	110~120V	HP	10	15	15	15
		220~240V	HP	20	25	30	40
		200~208V	HP	40	40	60	60
	Three phase	220~240V	HP	40	50	60	75
		440~480V	HP	75	100	125	150
		550~600V	HP	75	75	125	150
	NEMA size			3	4	4	4
Size and weight	AC control	Weight	kg	2.4		5.4	
		Size(W × H × D)	mm	95 × 158 × 132		138 × 203 × 181	
	DC control	Weight	kg	2.3			
		Size(W × H × D)	mm	95 × 158 × 132			
Auxiliary(standard)						<b>2a2b</b>	
Auxiliary	Side mount			<b>GUA1</b>		-	
	Front mount			<b>GUA2, GUA4</b>		-	

## GT Type Thermal Overload Relays



Type				GT150		GT225	
Rated operational voltage, Ue	Screws clamp terminals			●	□	●	□
Rated insulation voltage, Ui				690V		690V	
Rated impulse withstand voltage, Uimp				690V		690V	
Trip class				6kV		6kV	
Setting range				10A, 20		10A, 20	
Size and weight	Weight			34~150A		65~240A	
	kg			0.67		2.5	
	Size(W × H × D)			mm		mm	
				95 × 109 × 113		147 × 141 × 184	

\* The safety cover of magnetic contactor and thermal overload relay is optional.

# Table of Specifications



400AF		
CC265*	CC330*	CC400*
Screw Only		
3pole		
690V		
1000V		
50/60Hz		
8kV		
1200 operations per hour		
5 mil. operations		2.5 mil. operations
1 mil. operations		0.5 mil. operations
300	350	450
80	90	125
265	330	400
147	160	200
265	330	400
147	160	225
225	280	350
160	200	250
185	225	300
300	350	450
-	-	-
-	-	-
75	100	125
100	125	150
200	250	300
200	250	300
5	5	5

9.2  
163 × 243 × 198

2a2b		
-		
-		



GT400		
●		
690V		
690V		
6kV		
10A, 20		
85~400A		
2.6		

151 × 171 × 198



800AF		
CC500*	CC630*	CC800*
Screw Only		
3pole		
690V		
1000V		
50/60Hz		
8kV		
1200 operations per hour		
2.5 mil. operations		0.5 mil. operations
580	660	900
147	190	220
500	630	800
265	330	440
500	630	800
265	330	500
400	500	720
300	400	500
380	420	630
580	660	900
-	-	-
-	-	-
150	200	200
200	250	300
400	500	600
400	500	600
6	6	7

22.4  
285 × 312 × 242

2a2b		
-		
-		



GT800		
●		
690V		
690V		
6kV		
10A, 20		
200~800A		
11.5		

360 × 530 × 212

# Type Numbering System

## Midi-Contactor

<b>CC</b> Magnetic 3-pole Midi-Contactor	<b>9</b> Amperage Size	<b>BLANK</b> Type 3-pole /4-4-pole	<b>S</b> Terminal Type S - Screw L - Lug (>50A)	<b>A</b> Coil Type A - AC type D - DC type	<b>120</b> Coil Voltage 24 - 24V 120 - 120V & 600 - 600V	<b>BLANK</b> AC Coil Frequency - 50/60 Hz 50Hz - 50Hz only 60Hz - 60Hz only	<b>BLANK</b> Auxiliary Contact s - standard arrangement <b>NOAUX</b> - no aux. contact (>=32A)
	9 - 9A 12 - 12A 18 - 18A 22 - 22A 32 - 32A 40 - 40A 50 - 50A 65 - 65A 75 - 75A 85 - 85A 100 - 100A						

## Overload

<b>GT</b> Bimetallic Midi-Overload	<b>32</b> Frame Size	<b>BLANK</b> Class class 10 L - class 20	<b>S</b> Terminal Type (Must match contactor number) S - Screw L - Lug (>35A)	<b>0.16A</b> Setting Ranges (Use upper limit in part)
	32 - 9, 12, 18A 22, 32, 40A 65 - 50, 65A 75 - 75, 85, 100A			0.1 ~ 0.16A 0.16 ~ 0.25A 0.25 ~ 0.4A 0.4 ~ 0.63A 0.63 ~ 1A 1 ~ 1.6A 1.6 ~ 2.5A 2.5 ~ 4A 4 ~ 6A 5 ~ 8A 6 ~ 9A 7 ~ 10A 9 ~ 13A 12 ~ 18A 16 ~ 22A 18 ~ 25A 22 ~ 32A 24 ~ 36A 28 ~ 40A 34 ~ 50A 45 ~ 65A 54 ~ 75A 63 ~ 85A 70 ~ 95A 80 ~ 100A (Setting Range Guide)
<b>CGE</b> Electronic Midi Overload	<b>22</b> Frame Size	<b>3P</b> Protection Direct Mount 22 and 40AF 2P - 2-Pole 3P - 3-Pole 3PR - 3-pole Separate Mount All CGE sizes 2S - 2-Pole 3S - 3-Pole 3SR - 3-Pole	<b>22A</b> Setting Range (Use upper limit in part) <b>CGE22</b> 0.3 ~ 1.5A 1 ~ 5A 4.4 ~ 22A <b>CGE40</b> 4 ~ 20A 8 ~ 40A <b>CGE80</b> 16 ~ 80A	22 - 9, 12, 18, 22A 40 - 32, 40A 80 - 50, 65, 75, 85A
			Tunnel Type 22 and 40AF 2T - 2-Pole 3T - 3-Pole 3TR - 3-Pole	GT32 GT65 GT95

## Optional Accessories

### Auxiliary contact unit



Version	Contact composition
GUA1 Side mount	11 1NO+1NC
GUA2 Front mount(2P)	20 2NO
GUA4 Front mount(4P)	02 2NC
	40 4NO
	31 3NO+1NC
	22 2NO+2NC
	13 1NO+3NC
	04 4NC

### Surge absorber



Composition and voltage
1 Varistor+RC AC/DC 24~48V
2 Varistor+RC AC/DC 100~125V
3 Varistor+RC AC/DC 200~240V
4 Varistor+RC AC 380~440V
5 Varistor+RC AC 24~48V
6 Varistor+RC AC 100~125V
11 Varistor AC 200~240V
12 Varistor DC 24~48V
13 Varistor DC 100~125V
14 Varistor DC 200~220V
22 RC AC 100~125V

Note) See page 52 for details.

### Interlock unit



#### Contact composition

02	2NC
----	-----

### Wire kit for Interlocking



#### Frame size

22	22AF
32	32AF
63	63AF
95	95AF

### Separate mounting unit (For relay)



#### Frame size

32	32AF
63	63AF
95	95AF
150	150AF

### Remote reset unit (For relay)



#### Cable length

16	400
20	500
24	600

# Environment / Connections

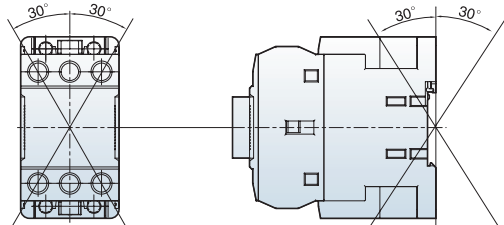

## Environment

Standards	IEC/EN 60947-1, IEC/EN 60947-4-1, UL508, K60947
Certifications	CE, UL
Rated insulation voltage (Ui)	1000V
Rated impulse withstand voltage (Uimp)	8kV
Degree of protection	IP20 (Conforming to IEC60529)
Ambient air temperature	Storage: -50° C ~ +80° C Operation: -5° C ~ +60° C
Operating altitude	3000m (8900ft)
Operating positions	
Shock resistance (1/2 sine wave =11ms)	Opened: 8G Closed: 10G
Vibration resistance (Conforming to IEC68-2-6) (5...300 Hz)	Opened: 2G Closed: 4G
Flame resistance	Conforming to UL 94: Vo Conforming to IEC 695-2-1: 960° C

## Connections

Frame	Wire type	Main Terminal Size	Wire types						Torque		
			(AWG / mm <sup>2</sup> )						mm(max)	[lb-in]	[Nm]
CC9		M4	18~10 / 1~6	18~10 / 1~6	18~10 / 1~6		9.6	20	2.25		
CC12			18~10 / 1~6	16~10 / 1~6	16~10 / 1~6						
CC18			18~10 / 1~6	16~8 / 1.5~10	16~8 / 1.5~10						
CC22		M5	18~10 / 1~6	14~8 / 2.5~10	14~8 / 2.5~10		12.8	35	4		
CC32			18~10 / 1~6	12~8 / 2.5~10	12~8 / 2.5~10						
CC40		M6	-	10~4 / 6~25	10~4 / 6~25		14	35	4		
CC50			-	8~3 / 10~35	8~3 / 10~35						
CC65			-	8~2 / 10~35	8~2 / 10~35						
CC75		M8	-	8~1/0 / 10~50	8~1/0 / 10~50		17	45	5.1		
CC85			-	8~2/0 / 10~70	8~2/0 / 10~70						
CC100		M8	-	3~2/0 / 35~70	3~2/0 / 35~70		24.5	80	9.1		
CC110			-	3~4/0 / 35~95	3~4/0 / 35~95						
CC130		M8	-	3~2/0 / 35~70	3~2/0 / 35~70		24.5	80	9.1		
CC150			-	3~4/0 / 35~95	3~4/0 / 35~95						
CC9~150		M4	20~14 / 0.5~2.5	18~12 / 0.75~2.5	18~12 / 0.75~2.5		7.6	15	1.75		
CC185		M10	-	1~4/0 / 50~95	1~4/0 / 50~95		25	130	14.7		
CC225			-	1/0~300 / 50~150	1/0~300 / 50~150						
CC265		M12	-	3/0~500 / 95~240	3/0~500 / 95~240		30	200	22.6		
CC330			-	4/0~500 / 95~240	4/0~500 / 95~240						
CC400		M16	-	350~700 / 185~185x2	350~700 / 185~185x2		40	500	26.5		
CC500			-	350~800 / 185~240x2	350~800 / 185~240x2						
CC630		M16	-	600~2000	-		40	500	26.5		
CC800			-	1700~Busbar	-						
CC185~800		M4	20~14 / 0.5~2.5	18~12 / 0.75~2.5	18~12 / 0.75~2.5		7.6	15	1.75		

a data sheet and specify products, visit [www.CarloGavazziOnline.com](http://www.CarloGavazziOnline.com)

# Control Coil Characteristics



Frame size		22AF	40AF	65AF	100AF	150AF
Type		CC9	CC32	CC50	CC75	CC130
		CC12	CC40	CC65	CC85	CC150
		CC12			CC100	
		CC22				
<b>AC coil</b>						
Control voltage	[Uc]	24, 32, 36, 42, 48, 80, 100, 110, 220, 230, 240, 380, 400, 415, 440, 500, 550V				24, 48, 110,
	50Hz [V]	24, 48, 100, 110, 120, 200, 208, 220, 230, 240, 277, 380, 440, 480, 600V				220, 300,
	60Hz [V]	24, 48, 100, 110, 120, 200, 220, 230, 240, 380, 415, 440, 500, 550V				400, 500
Voltage limit	[Uc]					
	Pick-up	85 ~110% (50Hz)				
	Drop-out	85 ~110% (60Hz)				
Coil consumption at 20°C		30 ~ 60%				
	AC 220V Inrush [VA]	58/56	53/50	110/104	229/216	108/104
	50/60Hz Holding [VA]	9.0/6.0	12.0/9.0	13.0/10.0	17.0/13.0	18.0/21.0
Heat dissipation	[W]	2.1/1.5	2.7/2.2	2.8/2.4	5.4/4.7	2.7/3.6
Operating time						
	Closing [ms]	12 ... 22	12 ... 22	12 ... 22	15 ... 30	20 ... 40
	Opening [ms]	4 ... 19	4 ... 19	4 ... 19	10 ... 30	60 ... 70
<b>DC coil</b>						
Control voltage	[Uc]	12, 20, 24, 48, 60, 80, 100, 110, 125, 200, 220, 250				24, 48, 110, 220
Voltage limit	[Uc]					
	Pick-up	70 ~ 110%				
	Drop-out	10 ~ 30%				
Coil consumption at 20°C						
	DC 110V Inrush [W]	9	7	9	18	213
	Holding [W]	9	7	9	18	7.5
Time constant (L/R)	[ms]	28	28	65	75	
Operating time						
	Closing [ms]	35 ... 50	50 ... 65	50 ... 65	100 ... 120	70 ... 80
	Opening [ms]	4 ... 19	4 ... 19	4 ... 19	10 ... 25	60 ... 70

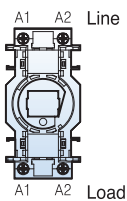

Note) A1(A2) in line side is internally connected to A1(A2) in load side.

To instantly view a data sheet and specify products, visit [www.GavazziOnline.com](http://www.GavazziOnline.com)

# Control Coil Characteristics



Frame size	225AF	400AF	800AF
Type	<b>CC185</b> <b>CC225</b>	<b>CC265</b> <b>CC330</b> <b>CC400</b>	<b>CC500</b> <b>CC630</b> <b>CC800</b>
<b>AC/DC common coil</b>			
Control voltage [Uc]			
AC/DC	24/24	-	-
AC/DC	48/48	-	100/100
AC/DC	100~240/100~220	100~240/100~220	200/200
AC	300	300	300
AC	400	400	400
AC	500	500	500
Voltage limit [Uc]			
Pick-up		86~110%	
Drop-out		30~60%	
Coil consumption at 20°C			
AC 220V Inrush [VA]	380	571	1000
50/60Hz Holding [VA]	11.6	14	29
Heat dissipation [W]	4.7	5	7.8
Operating time			
Closing [ms]	70	55	75
Opening [ms]	70	55	75



# Internal Structure

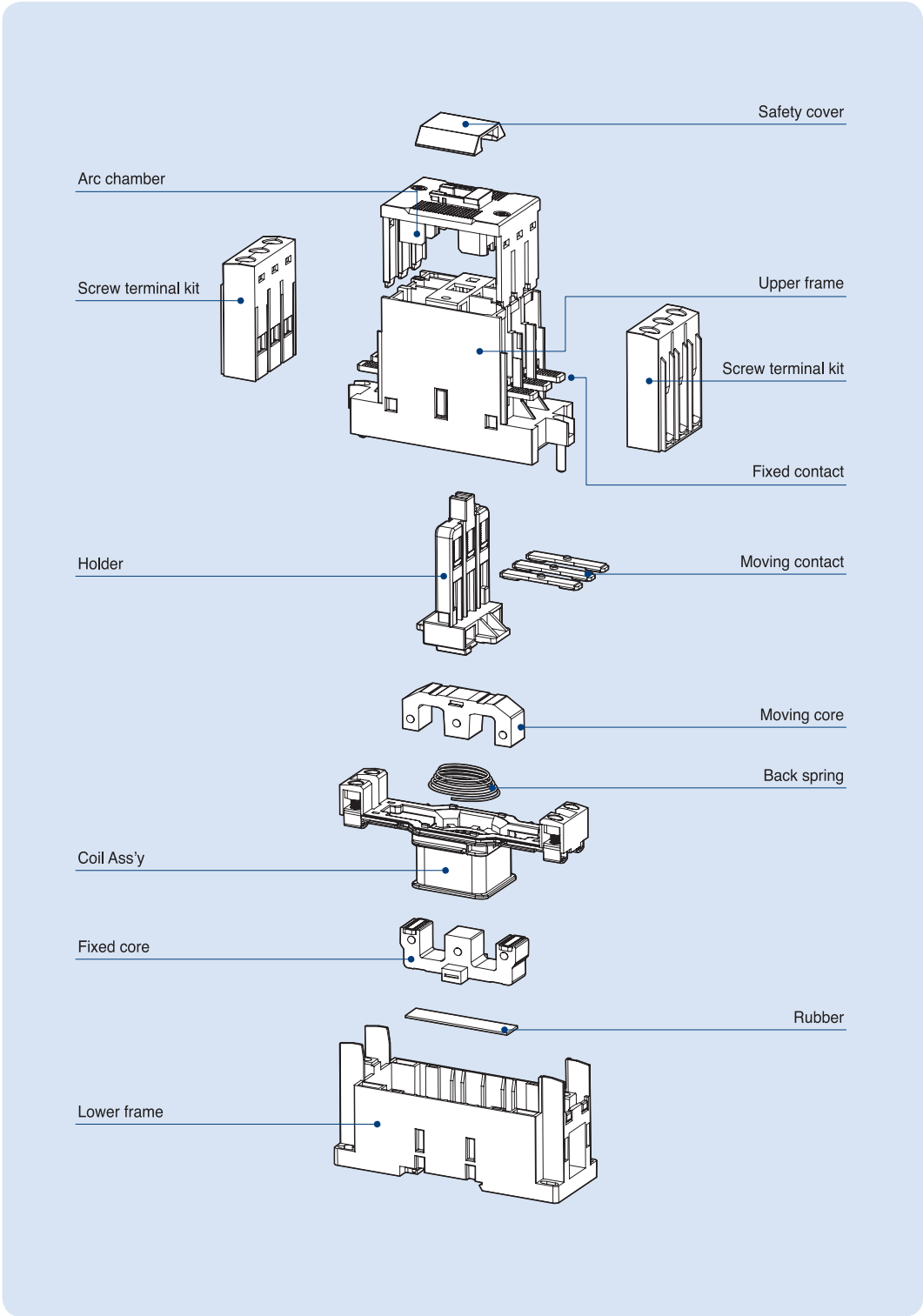

# Contactors (225AF)

## Description

- 3-pole main contact
- AC/DC common use coil built
- Wide coil operation voltage
- Screw mountable
- 2NO+2NC Auxiliary contacts built-in as standard
- Top/side mountable accessories available
- Direct mountable overload relays available

## Rating



Contactor type			CC185		CC225		
			kW	A	kW	A	
AC duty	AC3	200/240V	55	185	75	225	
		380/440V	90	185	132	225	
		500/550V	110	180	132	200	
		690V	110	120	140	150	
	AC4	200/240V	37	150	45	180	
		380/440V	75	150	90	180	
	AC1		-	230	-	275	
DC1 duty (L/R=1ms)	2-pole	24V	-	180	-	220	
		in series	48V	-	180	-	180
		110V	-	150	-	150	
	3-pole	24V	-	180	-	220	
		in series	48V	-	180	-	220
		110V	-	180	-	220	
DC2, 4 duty (L/R=15ms)	2-pole	24V	-	180	-	220	
		in series	48V	-	150	-	150
		110V	-	120	-	120	
	3-pole	24V	-	180	-	220	
		in series	48V	-	180	-	220
		110V	-	150	-	150	
Directly mountable Overload relay			<b>GT225</b>				
Conductor size (solid, stranded) (the max. number of conducts: 2)	AWG		1~410		110~300		
	mm <sup>2</sup>		50~95		50~150		
Conductor type			75 °C Cu stranded wire				



## Coil Voltage, AC/DC Common

Nominal (ordering) voltage	AC 50/60Hz	DC
24V	24 - 25V	24V
48V	48 - 50V	48V
100/200V	100 - 240V	100 - 220V
300V	265 - 347V	-
400V	380 - 450V	-
500V	440 - 575V	-

### Certification

- CE(IEC)
- UL508

# Contactors (225AF)

## Accessories

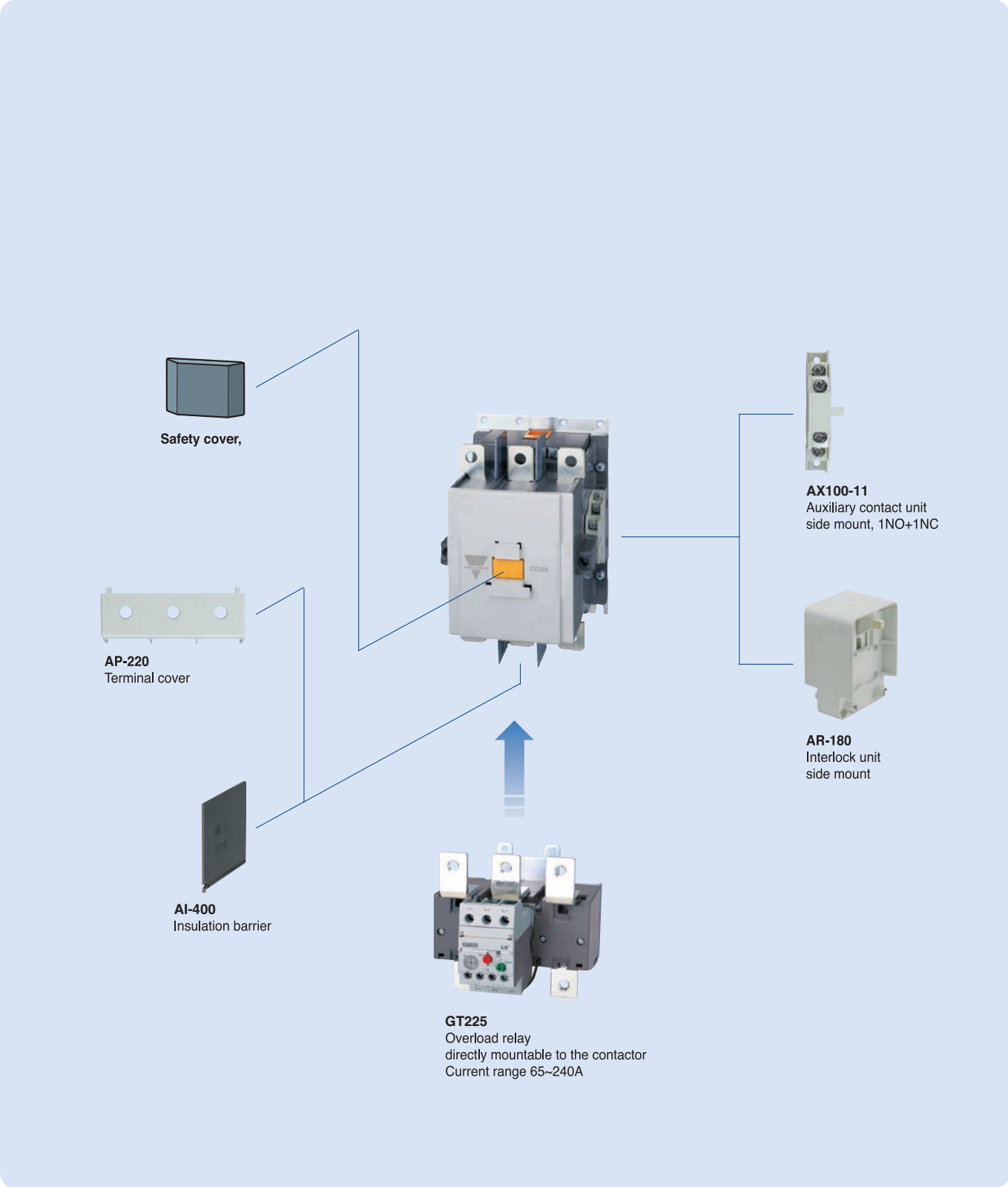

# Contactors (150AF ~ 800AF)

**CC130 ~ CC150**  
2NO2NC aux

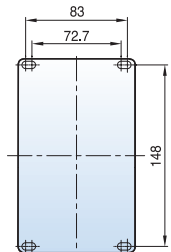
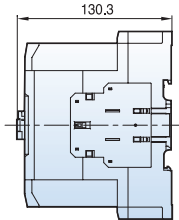
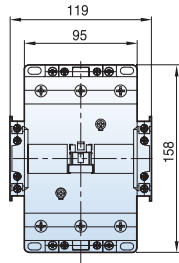

[mm]

2.4kg

**CC185 ~ CC225**  
2NO2NC aux

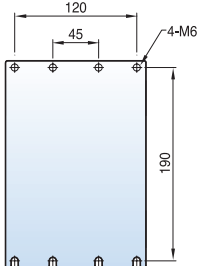
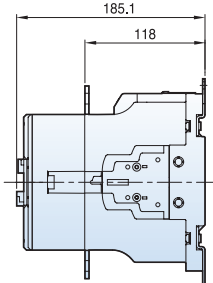
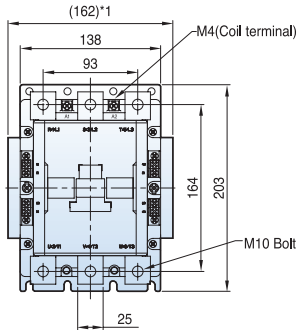

5.4kg

**CC265 ~ CC400**  
2NO2NC aux

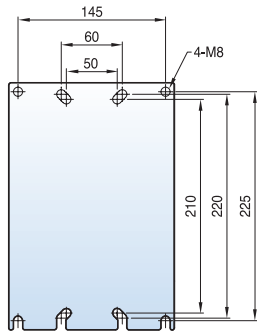
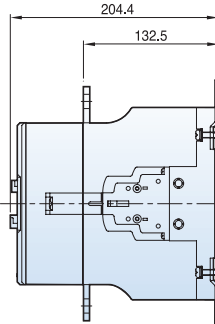
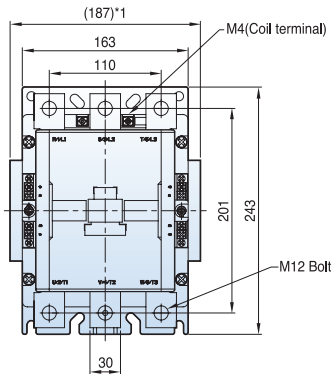

9.2kg

**CC500 ~ CC800**  
2NO2NC aux

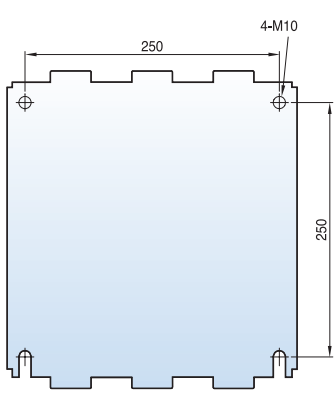
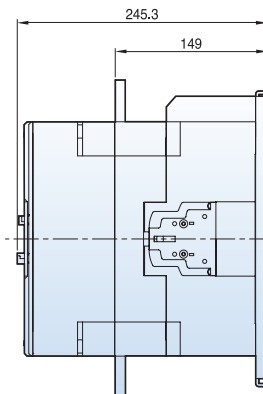
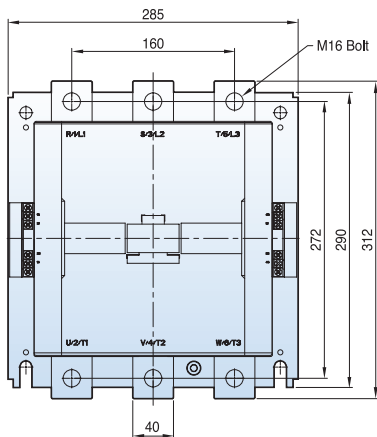

22.4kg

# Reversing Contactors and Starters (150AF ~ 800AF)

**CC130 ~ CC150**  
AC coil  
reversing  
combination  
shown with aux  
contacts

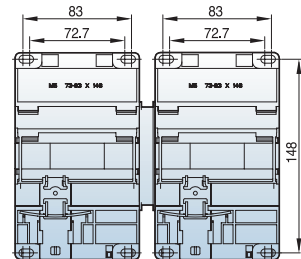
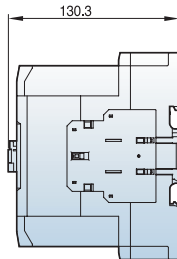
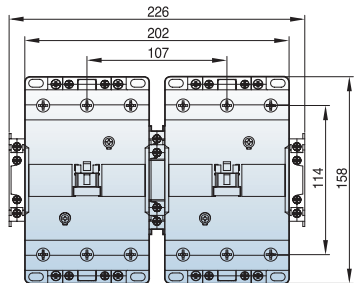

(mm)

4.3kg

**CC185 ~ CC225**  
reversing  
combination  
shown with aux  
contacts

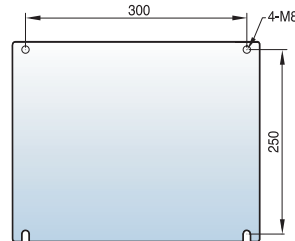
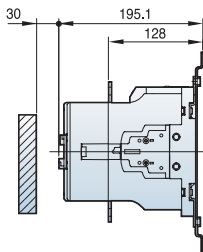
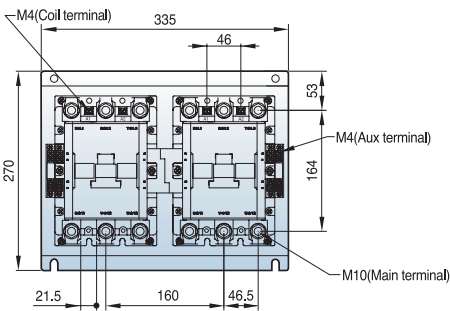

12.9kg

**CC265 ~ CC400**  
reversing  
combination  
shown with aux  
contacts

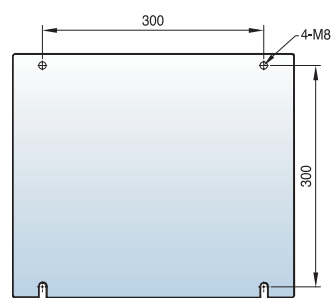
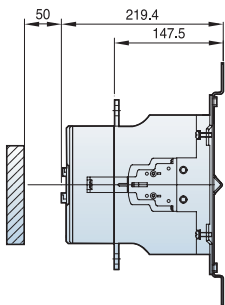
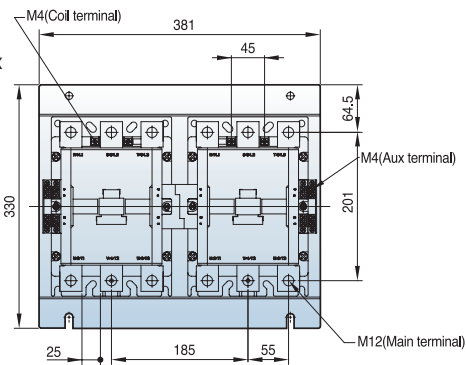

21.4kg

**CC500 ~ CC800**  
reversing  
combination  
shown with  
aux contacts

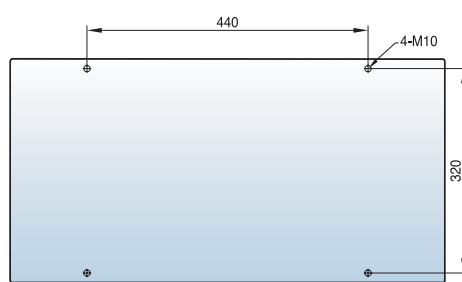
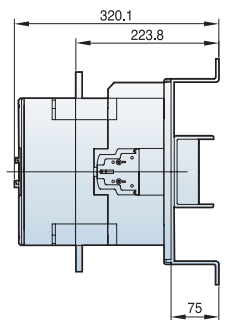
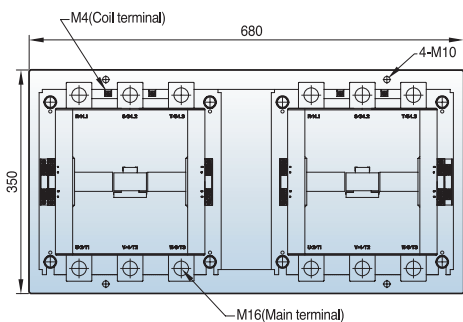

60kg

# Reversing Contactors and Starters (150AF ~ 400AF)

[mm]

**CC130 ~ CC150**  
AC coil  
reversing  
combination  
shown with GT150  
and aux contacts

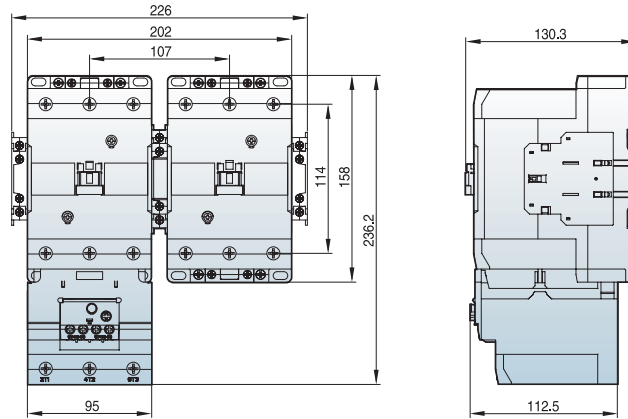

5kg

**CC185 ~ CC225**  
AC coil  
reversing  
combination  
shown with GT225  
and aux contacts

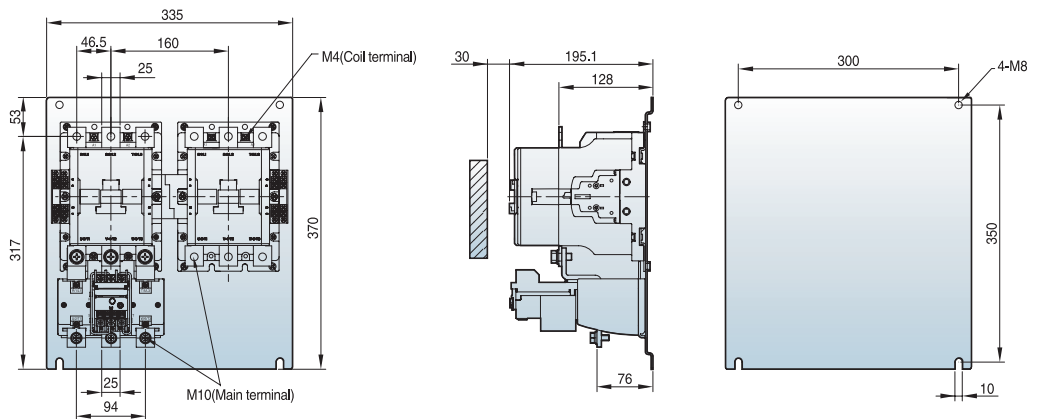

15.5kg

**CC265 ~ CC400**  
AC coil  
reversing  
combination  
shown with GT400  
and aux contacts

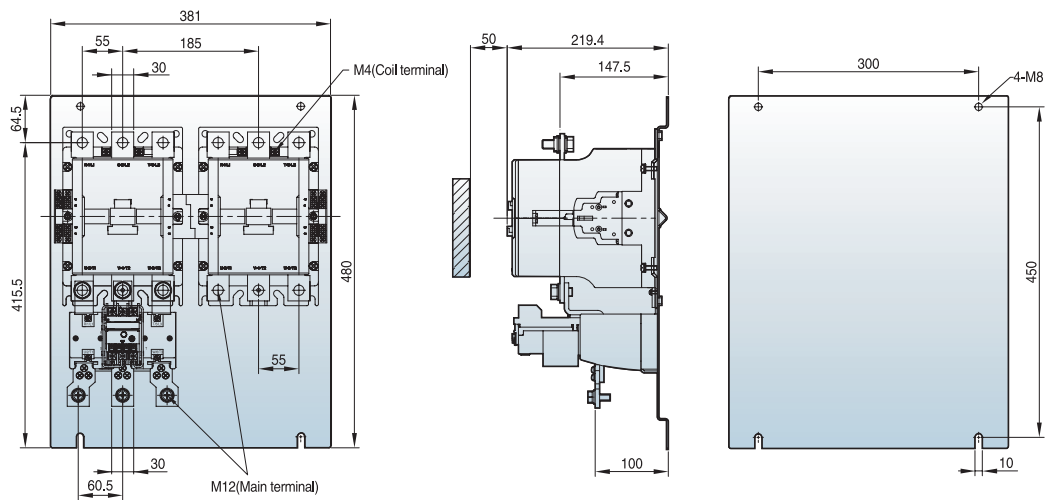

23kg