



SECURE QUARTER TURN LOCK



*Example with cam. Cam sold separately.

Specifications

- Material:
 - Housing: Zinc Alloy (Zamak) DIN-EN 1774-ZnAl4Cu1
 - Driver: Zinc Alloy (Zamak) DIN-EN 1774-ZnAl4Cu1
 - Cam: Steel or Plastic
 - Gasket: Rubber

Features

- When lock is open, key functions as a knob
- Applications: Electric panels, machinery covers

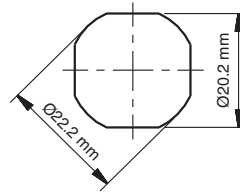
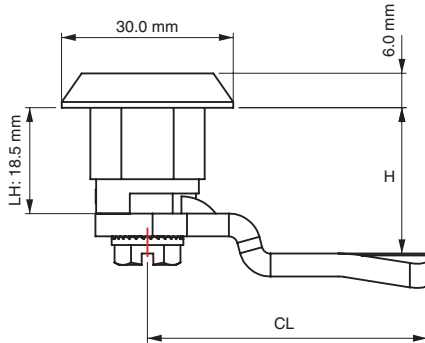

Cut Out

Key is removable at locked position

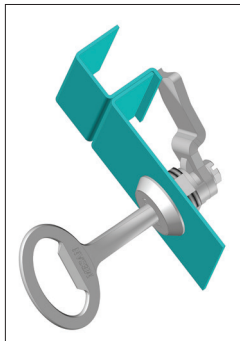
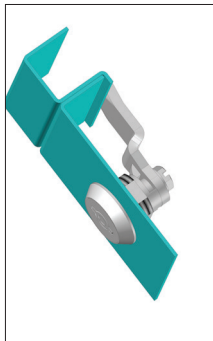

Key is not removable at open position, it works like a knob.

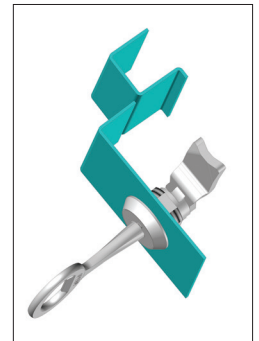

Driver/Head Style



5mm Double Bit

Item Number	Driver	Hand
30403439	5mm Double bit	Right
30403063	5mm Double bit	Left

Steel Cam

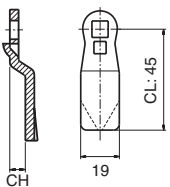
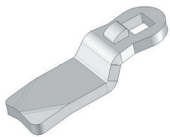

Material: Steel
 Finish: Zinc plated
 Thickness: 4 mm

Item Number	CH (mm)	CL (mm)	H (mm)
30403033	0	45	18.5
30403439	1	45	19.5
30403159	2	45	20.5
30403063	3	45	21.5
30403149	4	45	22.5
30403160	6	45	24.5
30403161	8	45	26.5
30403162	10	45	28.5
30403045	12	45	30.5
30403163	14	45	32.5
30403151	16	45	34.5
30403165	18	45	36.5

Item Number	CH (mm)	CL (mm)	H (mm)
30403166	20	45	38.5
30403167	22	45	40.5
30403168	24	45	42.5
30403169	-2	45	16.5
30403170	-4	45	14.5
30403171	-6	45	12.5
30403172	-8	45	10.5
30403173	-10	45	8.5
30403174	-12	45	6.5
30403175	-14	45	4.5