

SPECIFICATIONS

(RoHS Compliant)



Model Number: MFXE24Z3D3-E2
Part Number: 19044019A
SPEC Number: 26017480A Rev:00

Apr 03, 2013

Mechanical Drawing:

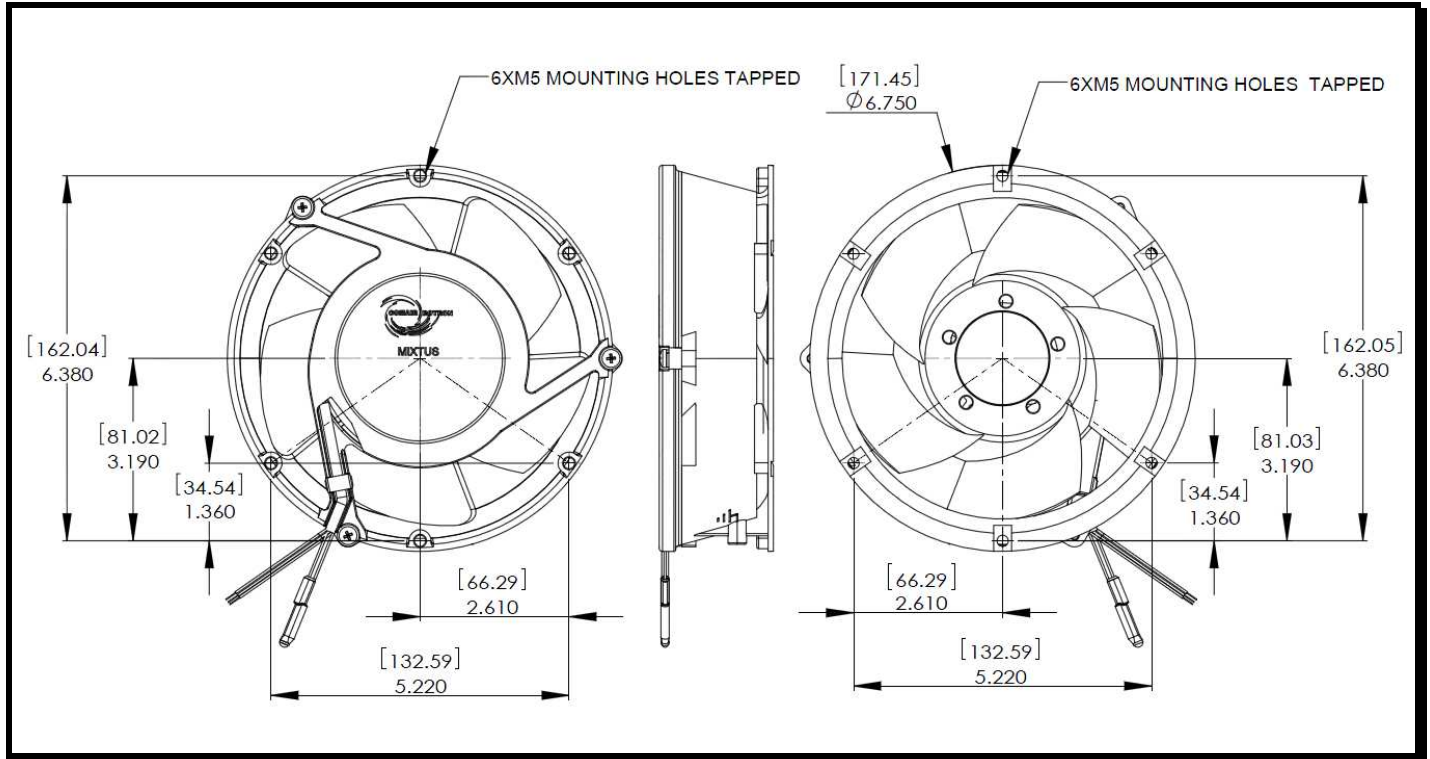

Motor:

Nominal Voltage = 24 vdc
Operating Voltage Range = 16 - 32vdc
Nominal Running Current = 3.1 amps
Max. Locked Rotor Current = 3.9 amps
Running Power = 74.4 watts
Average Speed = 5400 rpm
Bearings = Ball
Air Flow = 400 CFM
Acoustic = 69 dBA

Construction:

Venturi: Die Cast Aluminum Alloy, Black.
Propeller: Plastic, Black, UL 94V-0.

Agency Approvals:

UL, CE

Life Expectancy:

This fan is designed for continuous duty life of 75,000 hours at 40°C.

Additional Features:

Brushless DC Motor
Locked Rotor Protection
Reverse Polarity Protected
Automatic Restart Capability
Operating Temperature: -20°C to 70°C
Storage Temperature: -40°C to 85°C

Alarm Output (FPS):

Open Collector (NPN Transistor)
High on Pass, Low on Fail
Vcc: 32Vdc Max
Sink Current (Ic): 20mA Max
Isolated: No
Latching: No
Delay: 10±4s

Termination:

12" length lead wires, 20AWG, UL 1007
Black – Return(-)
Blue – FPS
Red – Power(+)



Comair Rotron Specification Sheet

Specification Date: Apr 03, 2013

24V Mixed Flow P-Q Curve

