

## SPECIFICATION CONTROL DRAWING

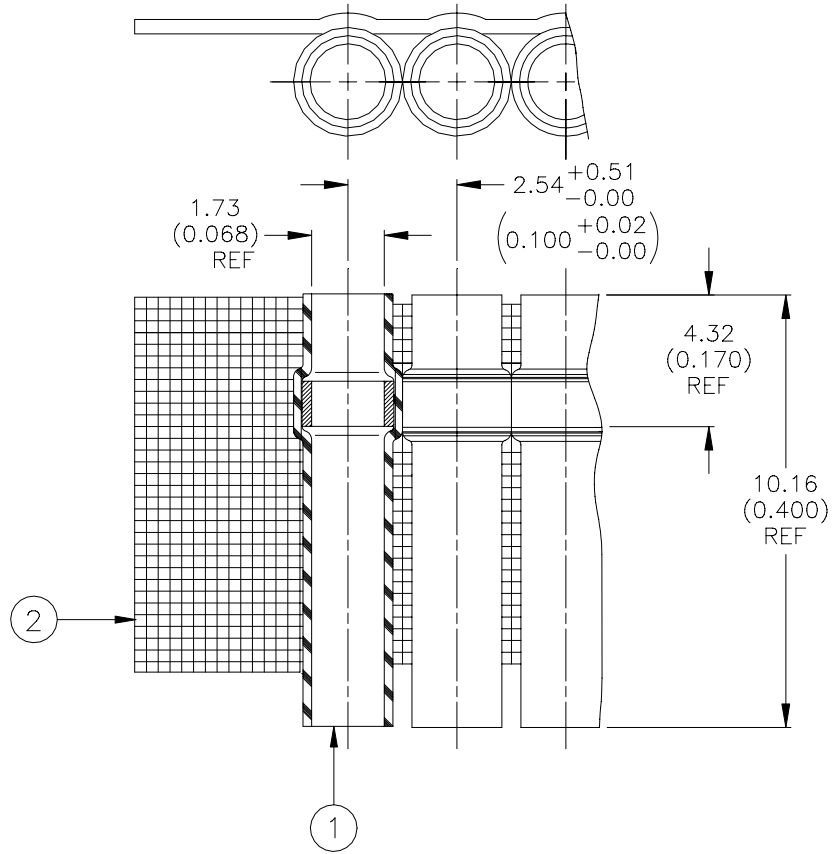

### MATERIALS

1. SOLDER SLEEVE WIRE TERMINATOR: D-128-0044, Quantity Per Assembly: 750
2. CARRIER STRIP: Adhesive Coated High Temperature Tape

### APPLICATION

1. This assembly is designed to be used with a Raychem AS-4000 Wire Organization System on Connectors with terminals on 2.54 (0.100) center spacing. For usage parameters, see Raychem Devices Specification Control Drawing D-128-0044.
2. Wire terminators are to be inspected to Raychem Devices Specification Control Drawing D-128-0044.

<b>Raychem Interconnect</b> <small>a division of tyco ELECTRONICS</small> 300 Constitution Drive Menlo Park, CA 94025, USA		<b>THERMOFIT DEVICES</b>	TITLE: <b>2.54 (0.100) center spacing SOLDERPAK ASSEMBLY FOR AS-4000 SLEEVE: D-128-0044</b>				
UNLESS OTHERWISE SPECIFIED DIMENSIONS ARE IN MILLIMETERS. INCHES DIMENSIONS ARE BETWEEN BRACKETS.			DOCUMENT NO.: <b>D-704-0062</b>				
TOLERANCES: 0.00 N/A 0.0 N/A 0 N/A	ANGLES: N/A  ROUGHNESS IN MICRON	Raychem reserves the right to amend this drawing at any time. Users should evaluate the suitability of the product for their application.	DCR NUMBER: <b>D000402</b>	REPLACES: <b>N/A</b>			
DRAWN BY: M. FORONDA	DATE: 18-July-00	PROD. REV. A	DOC ISSUE: 1	SCALE: None	SIZE: A	SHEET: 1 of 1	

If this document is printed it becomes uncontrolled. Check for the latest revision.