

Evaluation Board for CS4954/55

Features

- Demonstrates recommended layout and grounding practices
- Supports both parallel and serial digital video input
- On-board test pattern generation
- Supports NTSC/PAL video formats
- 3.3 V or 5 V operation
- Composite, S-Video, and RGB outputs
- Supports Standalone mode via onboard DIP switch
- RS232 interface with PC
- Single 6-9 V external DC power supply
- Additional op-amps with open pads for prototyping additional filters

Description

The CDB4954A/55A board allows fast evaluation of the features of the CS4954 digital video encoders. The board may also be configured to accept external TTL level timing and data signals for use during system development.

Also, to simplify the demonstration of the features of the CS4954, the CDB4954A/55A is equipped with an on-board microcontroller and pre-programmed FLASH memory to facilitate configuration and evaluation of the CS4954 digital video encoder.

ORDERING INFORMATION

CDB4954A	Evaluation Board
CDB4955A	Evaluation Board

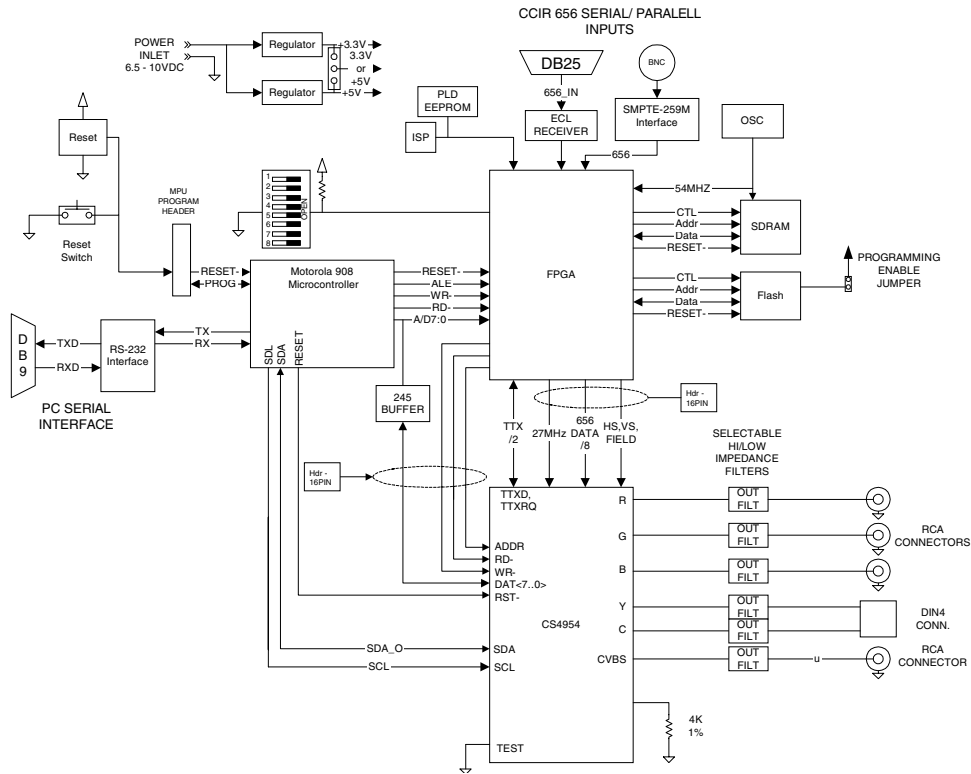

Preliminary Product Information

This document contains information for a new product. Cirrus Logic reserves the right to modify this product without notice.

TABLE OF CONTENTS

1. CDB4954A/55A SYSTEM OVERVIEW	4
2. SETUP ACTIVITIES	4
2.1 DIP Switch Options	4
2.2 Control Port Software	4
2.2.1 Changing a CS4954/5 or FPGA Register	4
2.2.2 Actions Menu	5
2.2.2.1 Convert to CCIR656 File Option	5
2.2.2.2 Video Input Source Option	6
2.2.2.3 Download a CCIR656 File to SDRAM and Display Option	6
2.2.2.4 Download a CCIR656 File to Flash Option	6
2.2.2.5 Display Video from Flash Option	6
2.2.2.6 Display Test Patterns Option	6
3. COMMAND LINE PARAMETERS	6
4. 3.3 V OR 5 V INTERFACE	6
5. DIGITAL VIDEO INTERFACE	6
6. ANALOG OUTPUT	6
7. OUTPUT FILTERS	6

LIST OF FIGURES

Figure 1. CDB4954A/55A Evaluation Board Interface	5
Figure 2. Register Edit Box	5
Figure 3. 300 Ω Filters.....	7
Figure 4. 75 Ω Filters.....	7
Figure 5. Digital Video Input.....	9
Figure 6. FPGA	10
Figure 7. CS4954/5	11
Figure 8. Microprocessor.....	12
Figure 9. Video Output Filters	13
Figure 10. Power/RS232 Interface	14
Figure 11. Silkscreen Top	15
Figure 12. Top Side.....	16
Figure 13. Power Layer	17
Figure 14. Ground Layer	18
Figure 15. Bottom Side.....	19

Contacting Cirrus Logic Support

For a complete listing of Direct Sales, Distributor, and Sales Representative contacts, visit the Cirrus Logic web site at:
<http://www.cirrus.com/corporate/contacts/>

Microsoft, Windows 95, Windows 98, Windows 2000, and Windows NT are registered trademarks of Microsoft Corporation. IBM is a registered trademark of International Business Machines, Inc. Macrovision is a registered trademark of Macrovision Corporation.

Preliminary product information describes products which are in production, but for which full characterization data is not yet available. Advance product information describes products which are in development and subject to development changes. Cirrus Logic, Inc. has made best efforts to ensure that the information contained in this document is accurate and reliable. However, the information is subject to change without notice and is provided "AS IS" without warranty of any kind (express or implied). No responsibility is assumed by Cirrus Logic, Inc. for the use of this information, nor for infringements of patents or other rights of third parties. This document is the property of Cirrus Logic, Inc. and implies no license under patents, copyrights, trademarks, or trade secrets. No part of this publication may be copied, reproduced, stored in a retrieval system, or transmitted, in any form or by any means (electronic, mechanical, photographic, or otherwise) without the prior written consent of Cirrus Logic, Inc. Items from any Cirrus Logic website or disk may be printed for use by the user. However, no part of the printout or electronic files may be copied, reproduced, stored in a retrieval system, or transmitted, in any form or by any means (electronic, mechanical, photographic, or otherwise) without the prior written consent of Cirrus Logic, Inc. The names of products of Cirrus Logic, Inc. or other vendors and suppliers appearing in this document may be trademarks or service marks of their respective owners which may be registered in some jurisdictions. A list of Cirrus Logic, Inc. trademarks and service marks can be found at <http://www.cirrus.com>.

LIST OF TABLES

Table 1. System Connections.....	7
Table 2. CBD4954 Jumper/Switch Settings.....	7
Table 3. DIP Switch Settings	8

1. CDB4954A/55A SYSTEM OVERVIEW

The CDB4954A/55A Evaluation Board allows the CS4954/55 NTSC/PAL Digital Video Encoder ICs from Cirrus Logic to be evaluated with a variety of internal and external video signals. DIP switches on the evaluation board allow external serial or parallel video to drive the CS4954/55, display test patterns contained in the evaluation board's control FPGA, and display NTSC images stored in FLASH. When the CDB4954A/55A (Microsoft Windows95[®], Windows 98[®], Windows NT[®], and Windows 2000[®] compatible) software is used, bitmaps up to 720x480 pixels may be converted to CCIR656 PAL or NTSC files, downloaded to SDRAM on the evaluation board and played from SDRAM through the CS4954/55. In addition, NTSC CCIR656 files can be stored to FLASH memory on the evaluation board for later play back. The CDB4954A/55A board supports Composite, RGB and S-Video outputs simultaneously.

The CDB4954A/55A has been partitioned into 6 schematics shown in [Figure 5](#), [Figure 6](#), [Figure 7](#), [Figure 8](#), [Figure 9](#), and [Figure 10](#). Notice that the partitioned schematics show the interconnections between the pages.

2. SETUP ACTIVITIES

Setup of the CDB4954A/55A is straightforward. DC Power is supplied to the board either via the supplied "wall wart" style power supply or by using the binding posts on the board (but not both!)

When the board is powered, the Power In LED (D6) will illuminate. If you're planning to use the supplied software, you will need to copy the files on the distribution disk shipped with the evaluation board to your hard disk drive. You should use the supplied 9-pin serial cable to connect your IBM[®] PC (or compatible) to the 9-pin D-Sub connector (labeled J6, RS-232) on the CDB4954A/55A.

2.1 DIP Switch Options

If you use the CDB4954A/55A Evaluation Board without a PC (i.e. in the standalone mode), use the followings to set up the board using the 8 position dip switch. The dip switch positions are marked 1-8. The individual switches select these functions:

Switches 1-4 select different operating modes. (Refer to [Table 3 on page 8](#) for more information.)

Switch 5 - Not Used

Switch 6 - PAL/NTSC data format.

Switch 7 - Pedestal Offset ON/OFF.

Switch 8 - Clipping Input Signals ON/OFF.

2.2 Control Port Software

The CDB4954A/55A is shipped with Microsoft[®] Windows[®] based software for interfacing with the CS4954/55 via the DB9 connector, J26. This software allows the user to have complete access to the control registers of the CS4954/55, as well as the ability to access some features of the on-board FPGA. A comprehensive online Help is included.

2.2.1 Changing a CS4954/5 or FPGA Register

There are two ways to change the values of either CS4954/55 or FPGA registers. When a register check box is checked, the corresponding register bit is set to a "1". When unchecked, the bit is set to "0". The first approach, shown on [Figure 1 on page 5](#), is to check or uncheck particular bit values in the desired register. For example, in [Figure 1](#), the CONTROL_0 configuration register of the CS4954/55 is set for CCIR656 mode (CCIR656 check box checked) and for video input from V[7:0] (IN_MODE check box checked). In addition, the background color generated by the CS4954/55 is set to blue (BLUE1 and BLUE0 check boxes are checked). The second approach is to click the register label above any set of register check boxes. This brings up a dialog which is

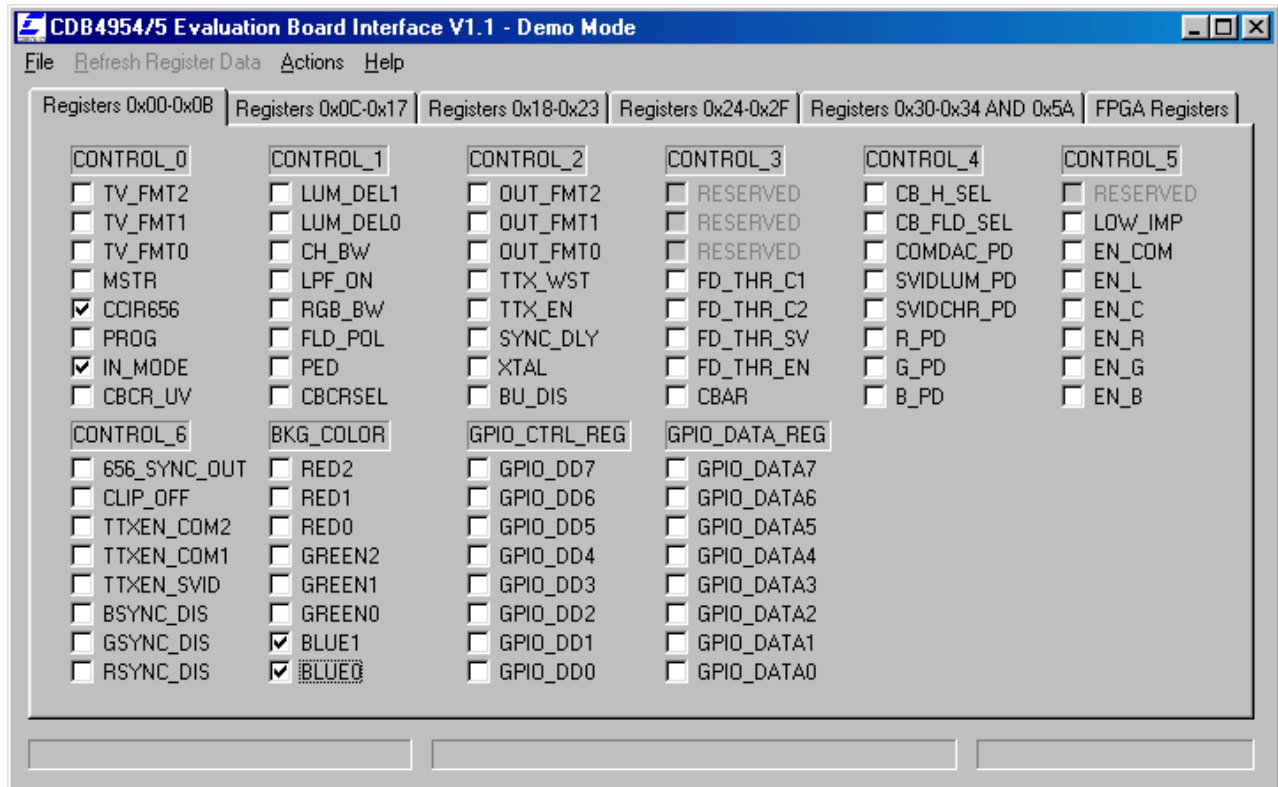

Figure 1. CDB4954A/55A Evaluation Board Interface

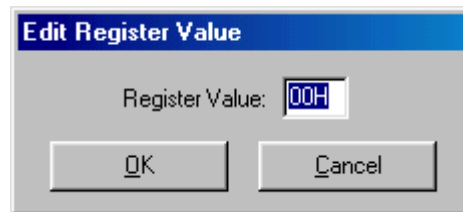

Figure 2. Register Edit Box

shown in [Figure 2](#). You can directly enter the hex value for all bits in the register and click the OK button. This will set all bits at once. The new value will be reflected in the pattern of checks in the register check boxes and immediately downloaded to either the CS4954/55 or the FPGA.

2.2.2 Actions Menu

If you use the CDB4954A/55A Evaluation Board with a PC, the Action Menu will allow you to convert bitmaps of up to 720x480 pixels to CCIR656 PAL or NTSC files. These converted files can then

be downloaded to the FLASH on the evaluation board for storage and later replay, or downloaded directly to SDRAM for immediate playing.

2.2.2.1 Convert to CCIR656 File Option

This option converts a bitmap image (“.bmp” file extension) of up to 720x480 into a CCIR656 NTSC (“.nts” file extension) or PAL (“.pal” file extension) file. This step is necessary before attempting to download either a NTSC or PAL image to SDRAM and displaying it. It is also necessary before saving an NTSC or PAL file to FLASH.

2.2.2.2 Video Input Source Option

This option selects the video source which will serve as input for the CS4954/55. Internal Video means all video content which is supplied by the FPGA. External parallel inputs use J4, the 25 pin D-Sub connector. External serial inputs use J19, the right angle BNC connector.

2.2.2.3 Download a CCIR656 File to SDRAM and Display Option

This option downloads a previously converted bitmap file to SDRAM on the evaluation board and displays it on the video outputs. Either a NTSC or a PAL format file may be downloaded and displayed, but the monitor used must be compatible with the downloaded file format to display correctly.

2.2.2.4 Download a CCIR656 File to Flash Option

This option downloads and stores a previously converted bitmap file to a block of on board Flash memory. FLASH block 1 contains the Cirrus logo screen in NTSC format, while FLASH block 2 contains the Cirrus logo screen in PAL format.

2.2.2.5 Display Video from Flash Option

This option displays video from one of the 3 FLASH blocks.

2.2.2.6 Display Test Patterns Option

This option displays one of the eight test patterns generated by the control FPGA. These patterns are color bars, luma bars, step, aqua screen, luma ramp (1 bit/2 pixel ramp rate), luma ramp (1bit/pixel), luma ramp (2bits/pixel), and luma ramp (4bits/pixel).

3. COMMAND LINE PARAMETERS

There are two valid command line parameters which can be used to modify the action of the program.

-f: This parameter shows the FPGA Register Values tab. This allows FPGA registers to be manipulated directly. Note that the FPGA Register is NOT part of the CS4954/55.

-m: This parameter shows the Macrovision[®] Registers tabs if a CS4955 is in place on the CDB4954A/55A Evaluation Board. If a CS4954 is in place on the board, the Macrovision Registers tabs are not shown (since the CS4954 doesn't have Macrovision support) whether or not the "-m" command line parameter is included.

4. 3.3 V OR 5 V INTERFACE

The CS4954 allows either 3.3 V or 5 V operation. The CDB4954A/55A evaluation board is built so that you can test this feature by changing jumper configurations. The voltage should only be changed when no power is applied. Please refer to [Table 1 on page 7](#).

5. DIGITAL VIDEO INTERFACE

The evaluation board is designed to accept the standard ITU-R BT.656 (i.e.: ECL) levels, but it also allows for TTL levels and SMPTE-259M serial digital interface to facilitate system development. Please refer to [Table 2 on page 7](#) for a description of all the connectors located on the board.

6. ANALOG OUTPUT

Before connecting equipment such as a monitor to one of the analog video outputs, verify that the jumper configuration for the video connectors are properly set for your application.

7. OUTPUT FILTERS

The filters present on the evaluation board are calculated for both high impedance loads (doubly terminated 300 Ω) and low impedance loads (doubly terminated 75 Ω). Please note that when in low impedance mode, only 3 DACs may be enabled. Refer to [Table 2 on page 7](#) for the proper configuration. Also, the CDB4954A/55A evaluation board allows for other filter topologies by providing an extra op-amp with open pads. Please refer to [Figure 9](#) for more detail.

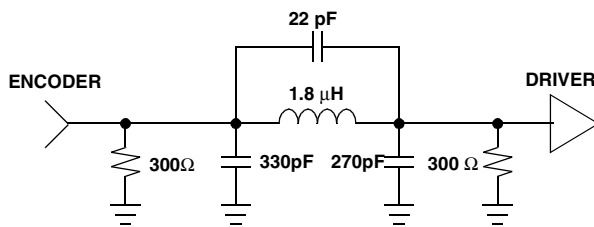
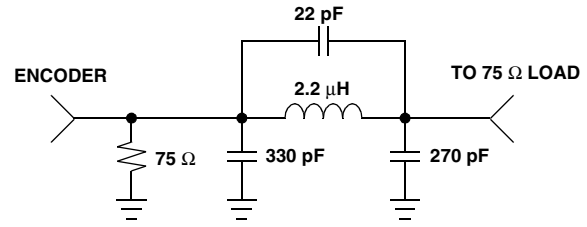
Figure 3. 300 Ω Filters

Figure 4. 75 Ω Filters

Connector	Input/Output	Description
J1	Input	6 - 9V DC Power Supply
J4	Input	656 Parallel Video Input
J11	Output	R Video Output
J12	Output	G Video Output
J30	Output	B Video Output
J14	Output	Composite Video Output
J16	Output	S-Video Output
J19	Input	656 Serial Video Input (-)
J35	Input	656 Serial Video Input (+)
J26	Input/Output	RS232 Interface

Table 1. System Connections

Header/Switch	Purpose	Jumper Position	Function Selected
J2	Voltage Supply Select	3.3V 5V	3.3 V Operation 5 V Operation
J5 J7	Output Test Point for Serial Receiver	-	Testpoints
J6	Phase Sensor Output	-	Testpoints
J8	FPGA Program/Debug Header	-	Testpoints
J9	Flash Write Enable	Jumpered Open	Write Enabled Write Not Enabled
J10	Testpoint from FPGA	-	Testpoints
J18	External 1.2V Source for CS4954	Jumpered Open	1.2 V Ex Source No 1.2 V Source
J28	MPU Debug	-	Testpoints
J32	Dig Video Input to CS4954	-	Testpoints
J33	Processor Bus to CS4954	-	Testpoints

Table 2. CBD4954 Jumper/Switch Settings

J34	GND Jumper for Dig Video Input	Jumpered Open	Gnd Connected No Gnd Connect
J3 J13 J15 J17 J20 J21 J22 J23 J24 J25 J27 J29 J31	High/Low Impedance Select NOTE: All Jumpers must be in the same position, namely High or Low. Also, only change impedance loading with the power off.	High Low	High Impedance Low Impedance
S1	DIP Switch for Stand Alone Mode	(See Table 3)	(See Table 3)
S2	Reset Switch	-	Resets the CDB4954A/55A

Table 2. CBD4954 Jumper/Switch Settings (Continued)

Switch	Purpose	Position	Function Selected
8	Clipping Input Signals	ON OFF	Clipping On Clipping Off (CS4954 Con Reg 6, bit 6)
7	Pedestal Offset	ON OFF	Pedestal Offset = 7.5 IRE Pedestal Offset = 0 IRE (CS4954 Con Reg 1, bit 1)
6	NTSC/PAL Format	ON OFF	PAL-B Mode NTSC-M Mode
5	Not Used	-	-
1-4	Operating Modes NOTE: OFF = 0 ON = 1	0000 1000 0100 1100 0010 1010 0110 1110 0001 1001 0101 1101 0011 1011	Display Color Bars (70% Amp, 70% Sat) Display Luma Bars (70% Amp, 70% Sat) Display a Luma Step Display an Aqua Screen Display a Luma Ramp (1 bit/2 pixels) Display a Luma Ramp (1 bit/ pixel) Display a Luma Ramp (2 bit/ pixel) Display a Luma Ramp (4 bit/ pixel) Select Parallel Video Input as External Source Select Serial Video Input as External Source Display Video from Flash Block 1 (Cirrus Logo - NTSC) Display Video from Flash Block 2 (Cirrus Logo - PAL) Display Video from Flash Block 3 Select the D656 Bus Header(J32) as external video input source.

Table 3. DIP Switch Settings

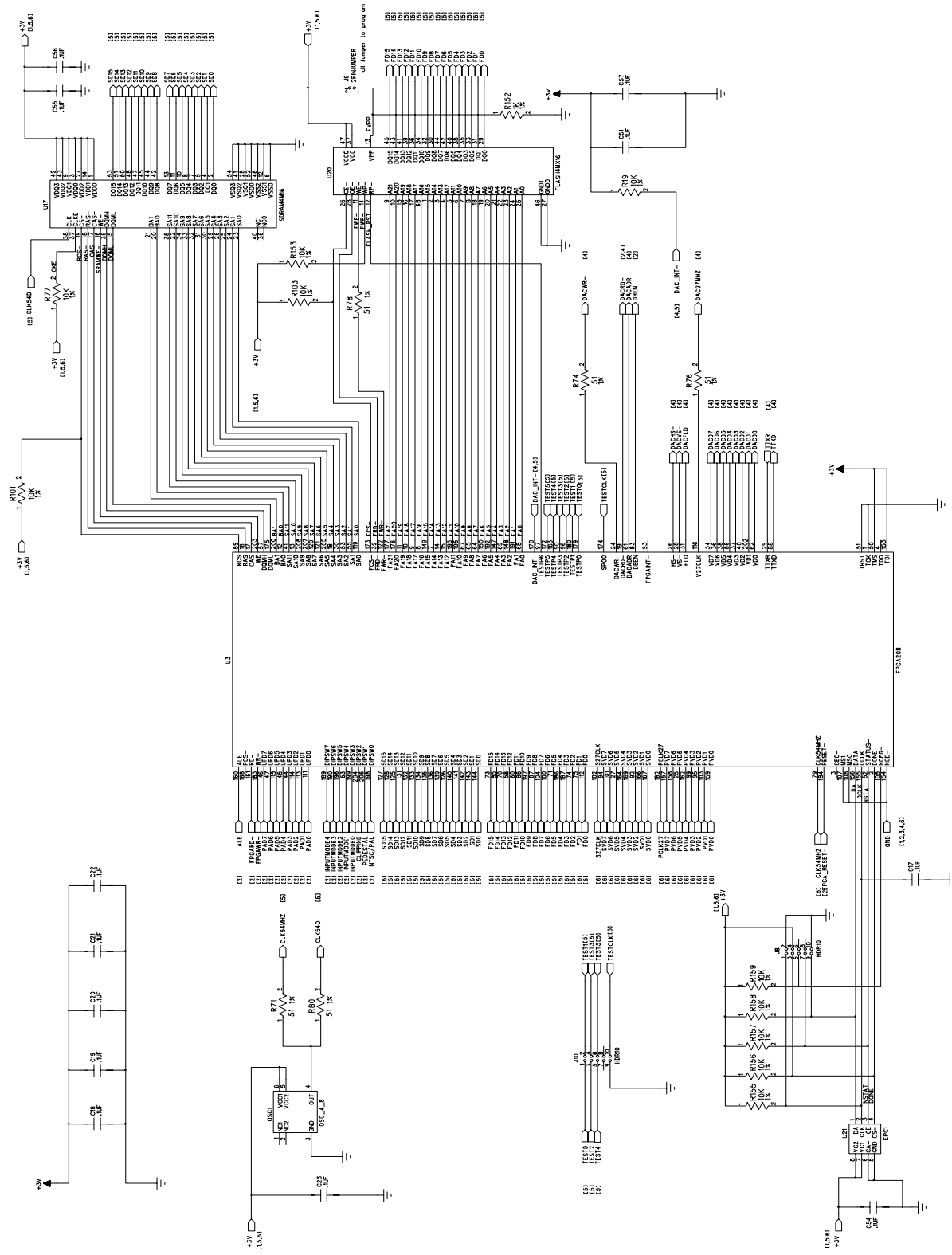

Figure 6. FPGA

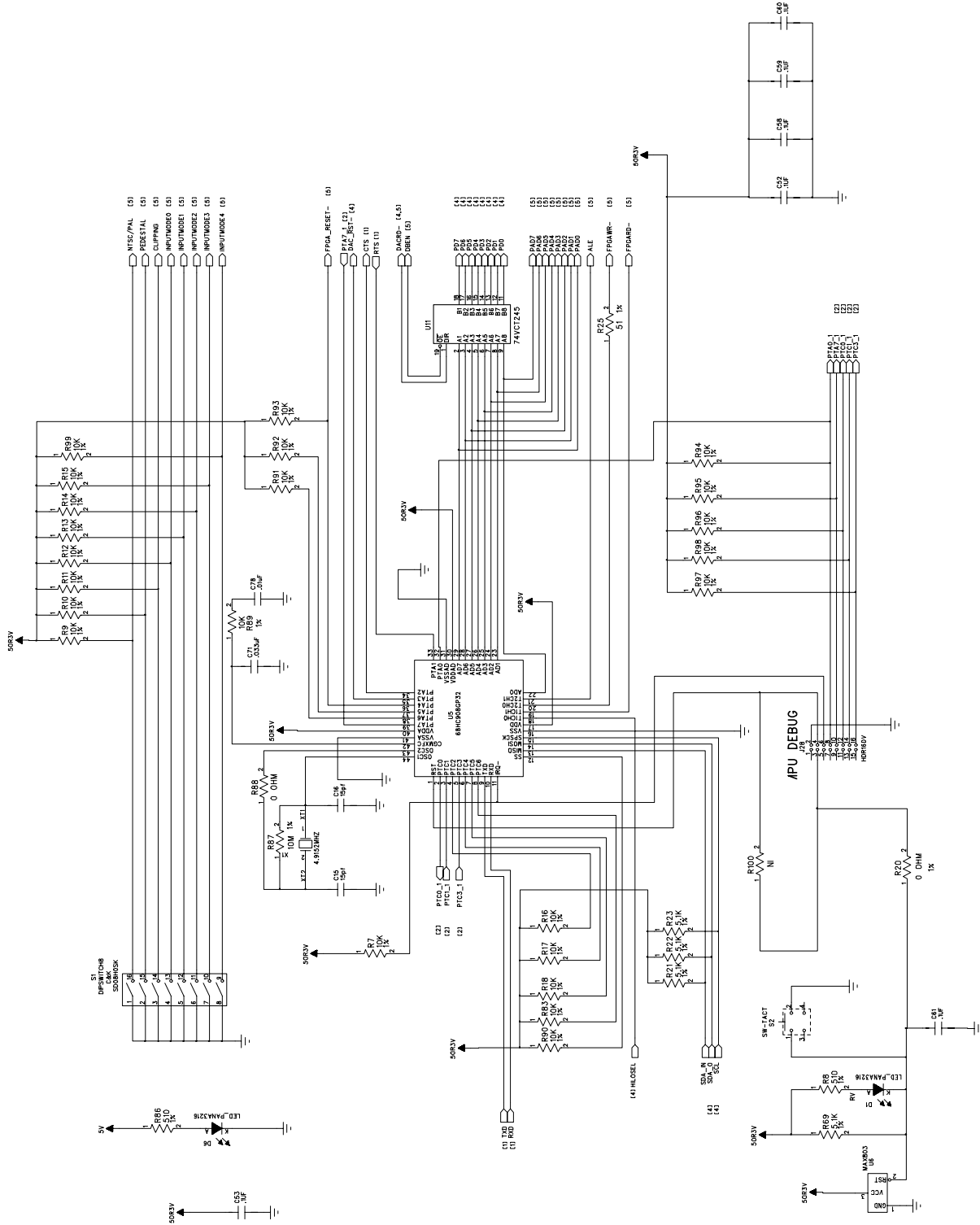

Figure 8. Microprocessor

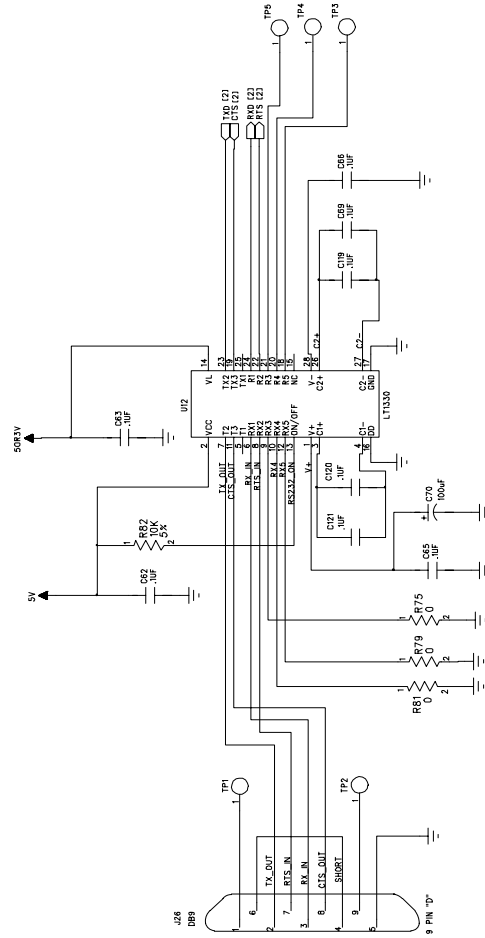
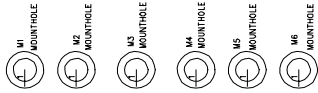
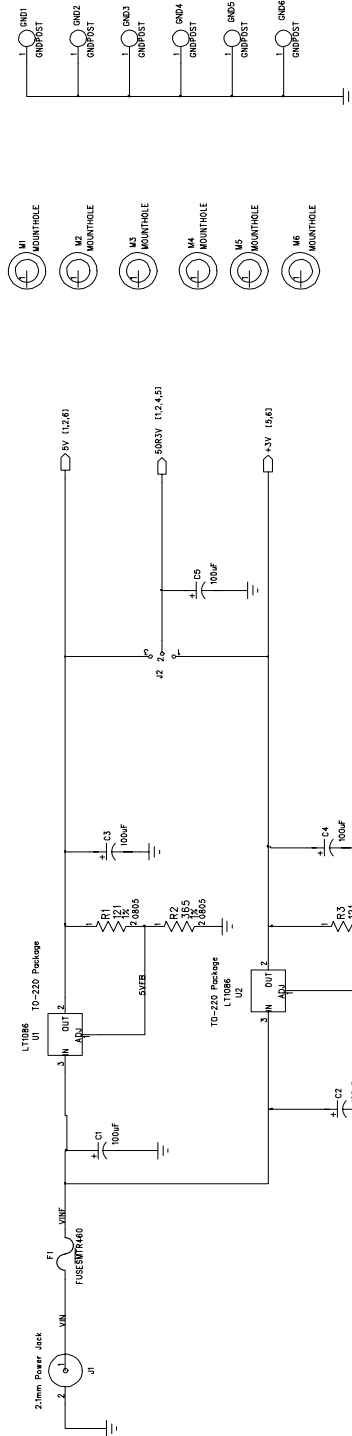
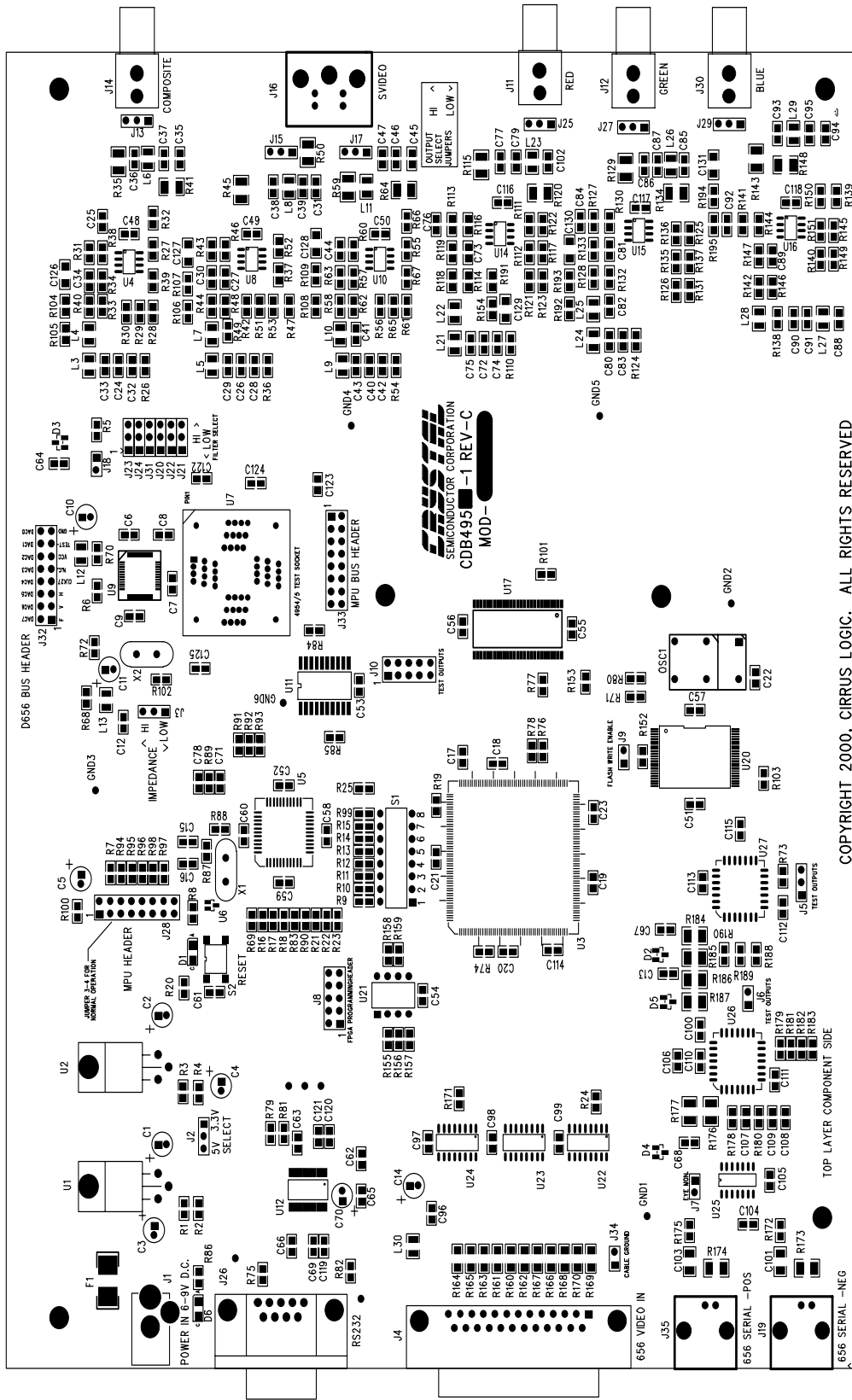

Figure 10. Power/RS232 Interface

CDB4954/5-1 REV.C



COPYRIGHT 2000, CIRRUS LOGIC. ALL RIGHTS RESERVED

TOP SIDE SILKSCREEN TOP

Figure 11. Silkscreen Top

CDB4954 / 5-1 REV.C

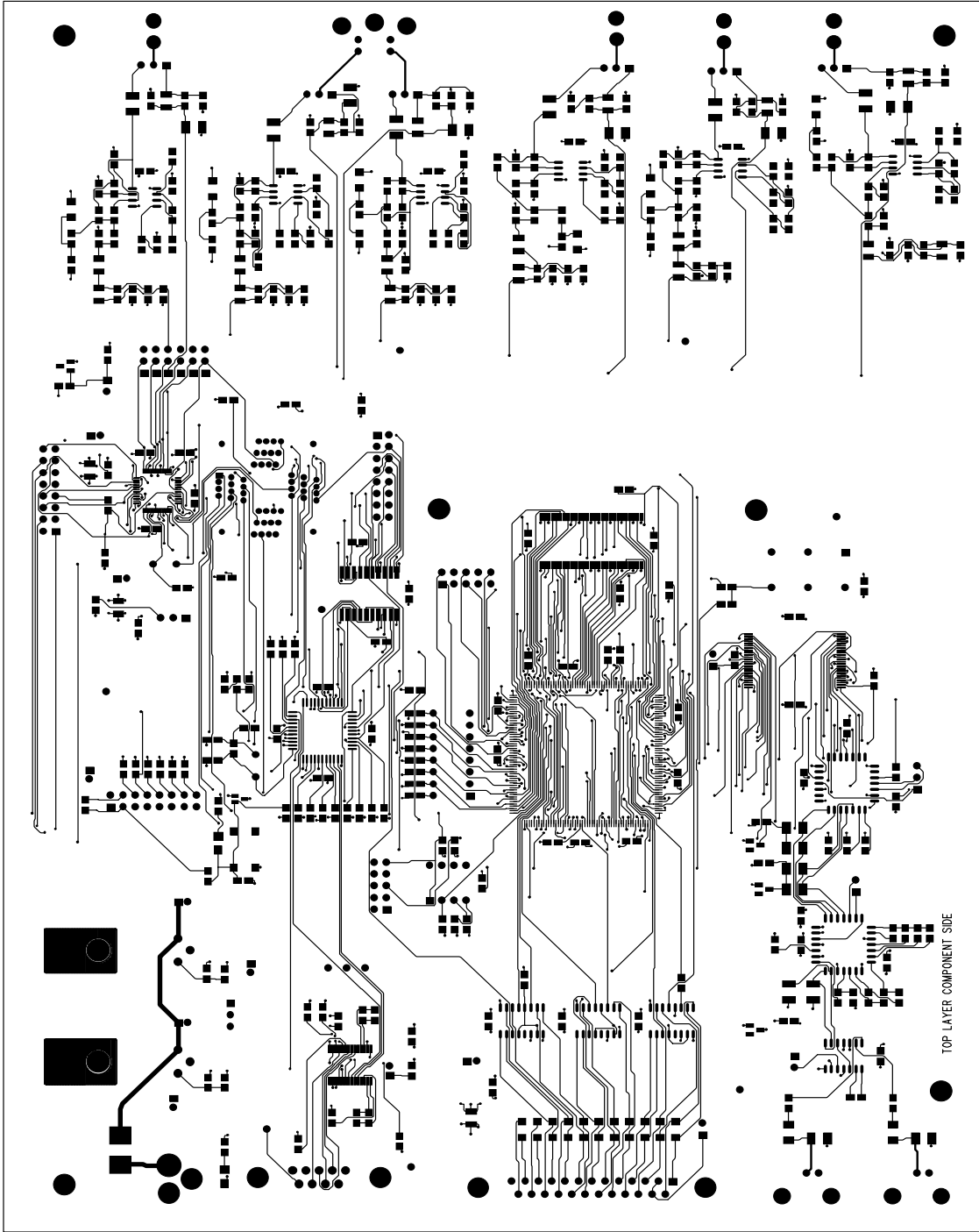

Figure 12. Top Side

CDB4954/5-1 REV.C

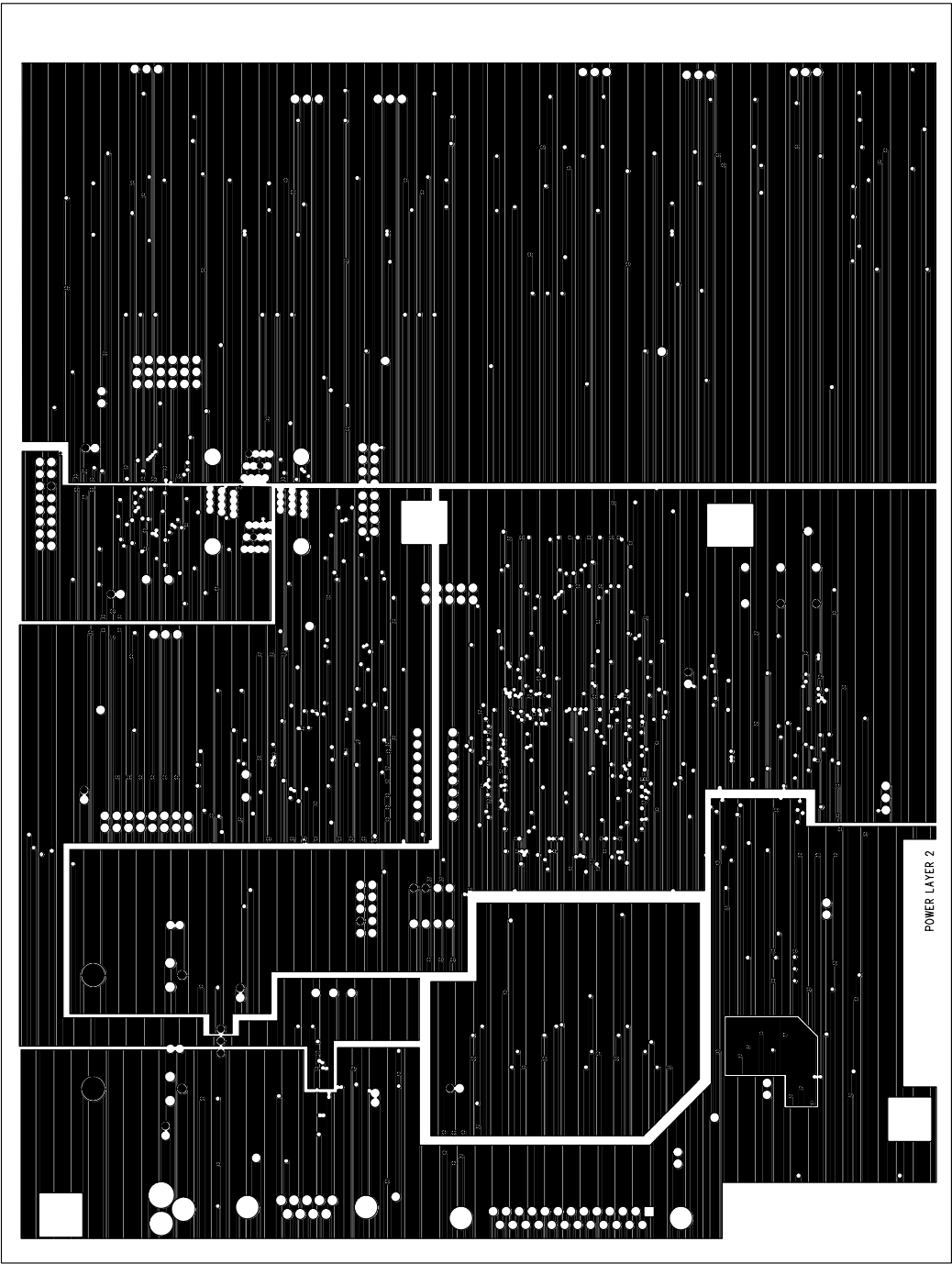

Figure 13. Power Layer

CDB4954/5-1 REV.C

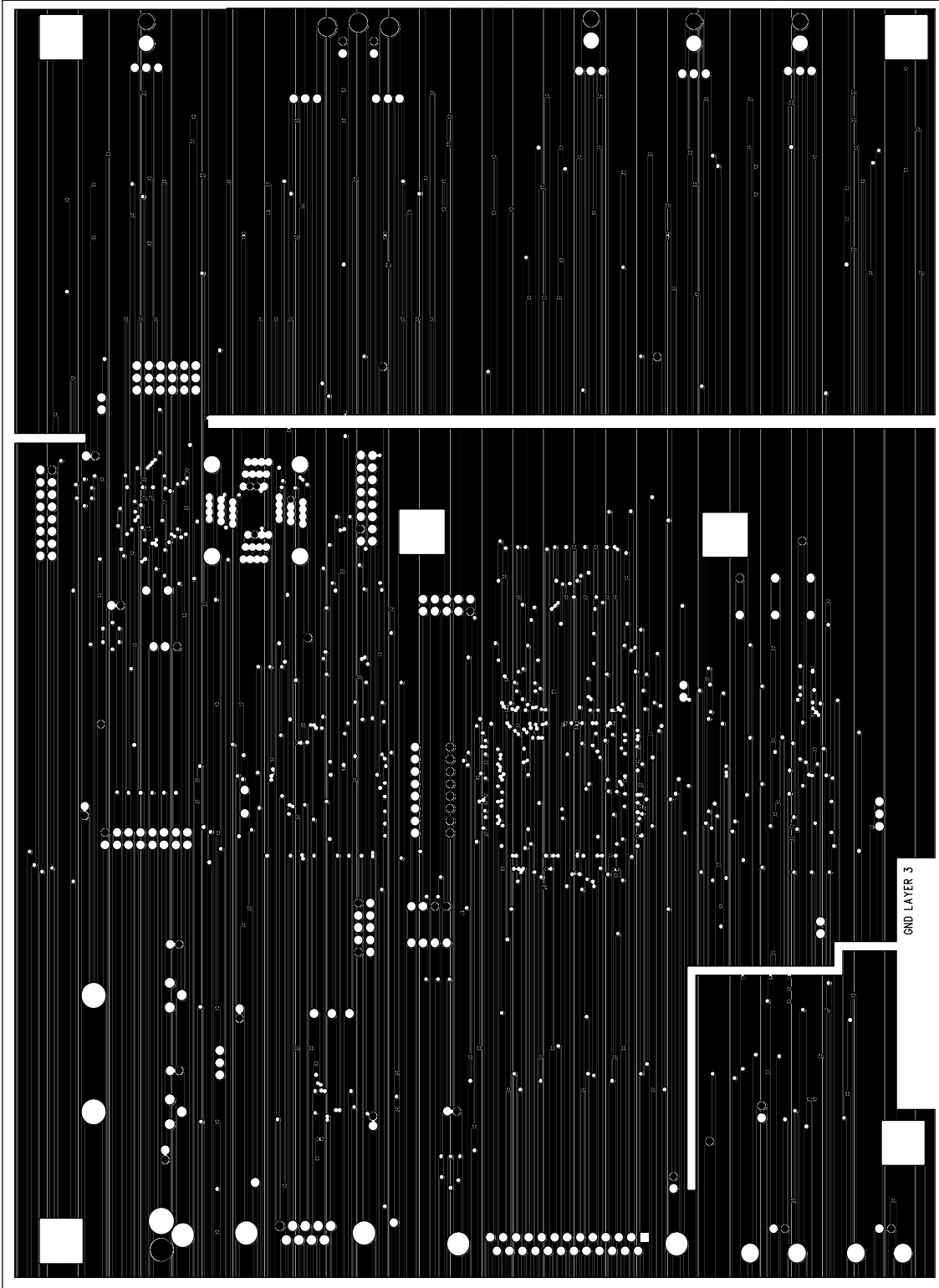
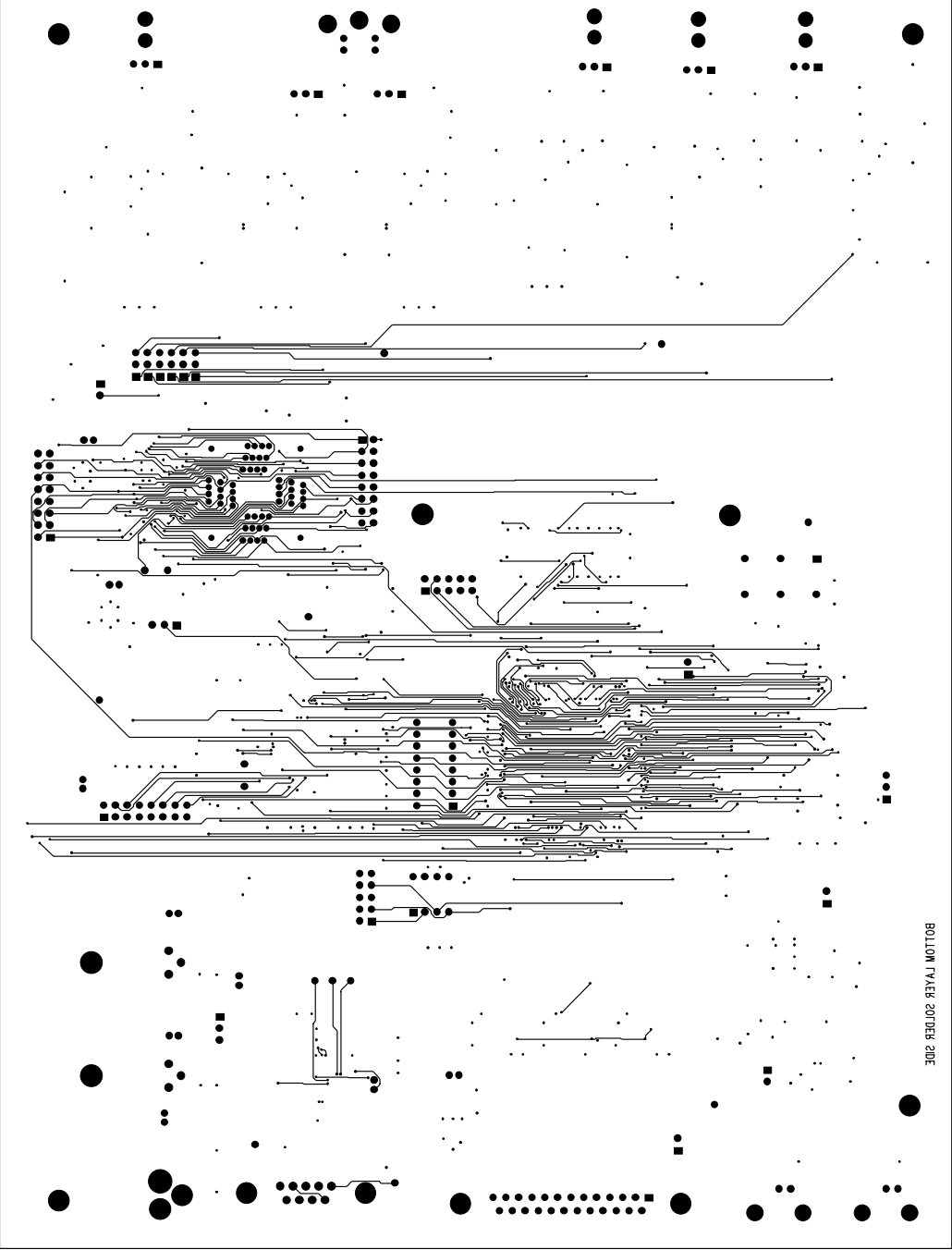

Figure 14. Ground Layer

CDB4954/5-1 REV.C



BOTTOM SIDE

Figure 15. Bottom Side

SMART
Analog™