

NCV74300V1GEVB

NCV7430 LIN RGB LED Driver Evaluation Board User's Manual

Introduction

The NCV74300V1GEVB is an evaluation board for single-chip RGB driver NCV7430, intended for dedicated multicolor LED applications. The RGB LED driver contains a LIN interface (slave) for parametric programming of LED color and intensity.

The device receives instructions through the LIN bus and subsequently drives the LEDs independently.

The NCV7430 acts as a slave on the LIN bus and the master can request specific status information (parameter values and error flags). The LIN address of the NCV7430 can be programmed in the internal memory of the device.

The design incorporates the lowest bill of materials, minimized board size and allows easy interconnection in case of multiple nodes network.

Features

- Small Size of PCB
- Two Parallelized Connectors for Easy Daisy-chain Connection

Applications

- Automotive Interior Lighting

Board Hardware

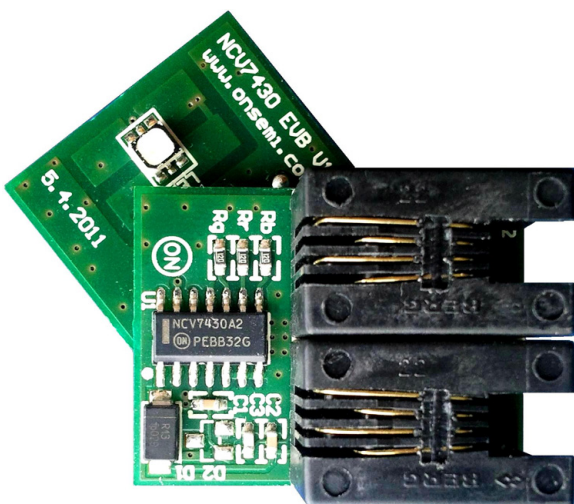

ON Semiconductor®

<http://onsemi.com>

EVAL BOARD USER'S MANUAL

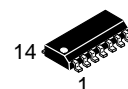

SOIC-14
D2 SUFFIX
CASE 751A

PIN ASSIGNMENT

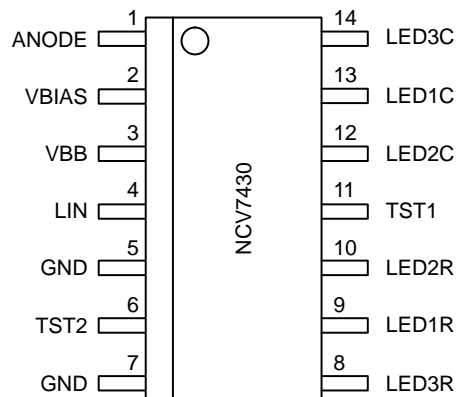

MARKING DIAGRAM

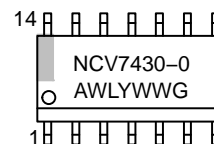

NCV7430 = Specific Device Code
A = Assembly Location
WL = Wafer Lot
Y = Year
WW = Work Week
G = Pb-Free Package

NCV74300V1GEVB

ABSOLUTE MAXIMUM RATINGS AND OPERATING RANGES

Table 1. ABSOLUTE MAXIMUM RATINGS

(The operation of the NCV7430 evaluation board works with the custom made ON Semiconductor LIN Interface in combination with the custom GUI interface. No additional power supply is needed other than the supplied 12 V AC/DC adapter which powers the LIN Interface through DC Power Input connector.)

Symbol	Parameter	Min	Max	Unit
LIN INTERFACE				
V _{BUS}	USB Supply Voltage	-0.3	5.5	V
V _{BAT}	External Supply Voltage	-0.3	42	V
I _{BAT}	Maximum Supply Current	-	2	A
V _{LIN}	Maximum Voltage at LIN Bus Pin	-45	45	V
T _A	Ambient Temperature	-40	85	°C

NCV7430 EVB

V _{BAT}	Supply Voltage	-0.3	43	V
V _{LIN}	Maximum Voltage at LIN Bus Pin	-45	45	V
T _J	NCV7430 Junction Temperature	-40	150	°C
T _A	Ambient Temperature	-40	125	°C

Stresses exceeding Maximum Ratings may damage the device. Maximum Ratings are stress ratings only. Functional operation above the Recommended Operating Conditions is not implied. Extended exposure to stresses above the Recommended Operating Conditions may affect device reliability.

Table 2. RECOMMENDED OPERATING RANGES

Symbol	Parameter	Min	Max	Unit
LIN INTERFACE				
V _{BUS}	USB Supply Voltage	4.75	5.25	V
V _{BAT}	External Supply Voltage	5.5	18	V
V _{LIN}	Operating Voltage at LIN Bus Pin	5.5	18	V
T _A	Ambient Temperature	-40	85	°C

NCV7430 EVB

V _{BAT}	Supply Voltage	5.5	18	V
V _{LIN}	Operating Voltage at LIN Bus Pin	5.5	18	V
T _J	NCV7430 Junction Temperature	-40	125	°C
T _A	Ambient Temperature	-40	105	°C

NCV74300V1GEVB

Table 3. PIN FUNCTION DESCRIPTION

Connector	Pin	Pin Name	Description
LIN INTERFACE			
Power			V _{BAT} External Power Supply Input (LIN Interface + NCV7430 EVB Supply)
LIN (RJ11)	1	V _{BAT}	V _{BAT} Supply Voltage Output/Input (LIN Interface can be supplied through this pin)
	2	LIN	LIN Bus Line
	3	GND	Ground Connection
	4	NC	Not Connected
USB			USB Connector
NCV7430 EVB			
RJ11 (J1, J2) (Note 1)	1	V _{BAT}	Battery Supply Input/Output (Note 2)
	2	LIN	LIN Bus Line
	3	GND	Ground Connection
	4	NC	Not Connected

- Both connectors pinout is identical.
- Connectors J1 and J2 are connected in parallel. Typically, J1 is a supply input while J2 is a supply output, which supplies the next board in the serial chain.

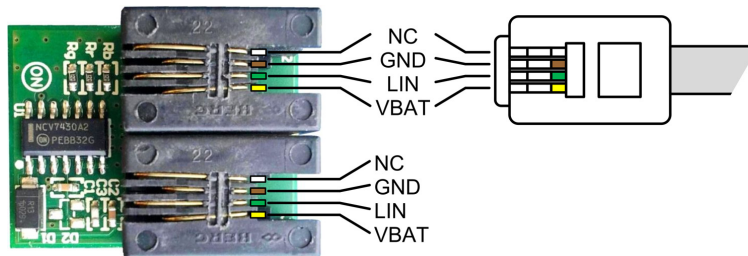

Figure 1. NCV7430 EVB Pins Connections

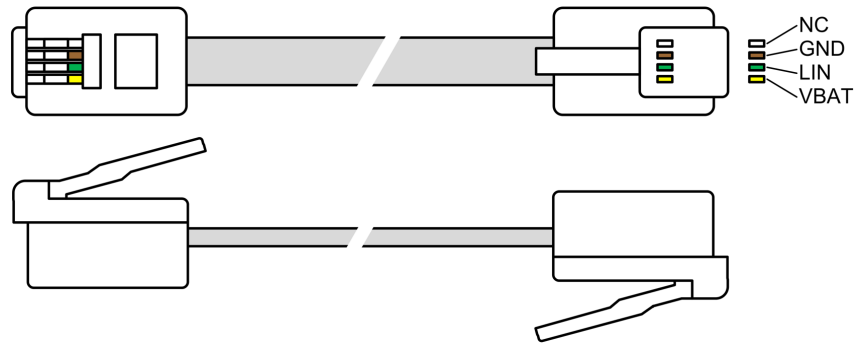

Figure 2. LIN Cable with RJ11 4P4C Connectors (Top View and Side View)

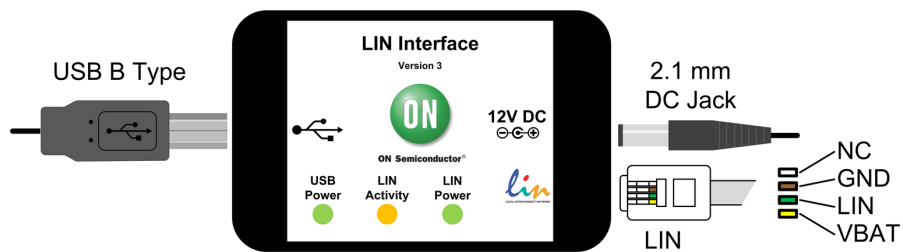

Figure 3. USB-LIN Interface Connectors

NCV7430V1GEVB

GETTING STARTED

This section contains instructions for the NCV7430 setup configuration and first connection. Only a few steps need be proceeded to get fully working simple LIN RGB LED network.

Please take the following steps to get a functional setup:

1. Install the NCV7430 Evaluation Software (see the NCV7430 Evaluation Software section for details). The USB drivers are included in the installation package. This installation requires administrator rights.

2. Connect LIN Interface to USB and wait until the device is installed. This step requires administrator rights.
3. Connect the boards according to figure below. Initially all the nodes have address set to default value 0. In case the node addresses haven't been set previously, connect only one node to USB-LIN interface to avoid having two nodes with same address connected to the network.

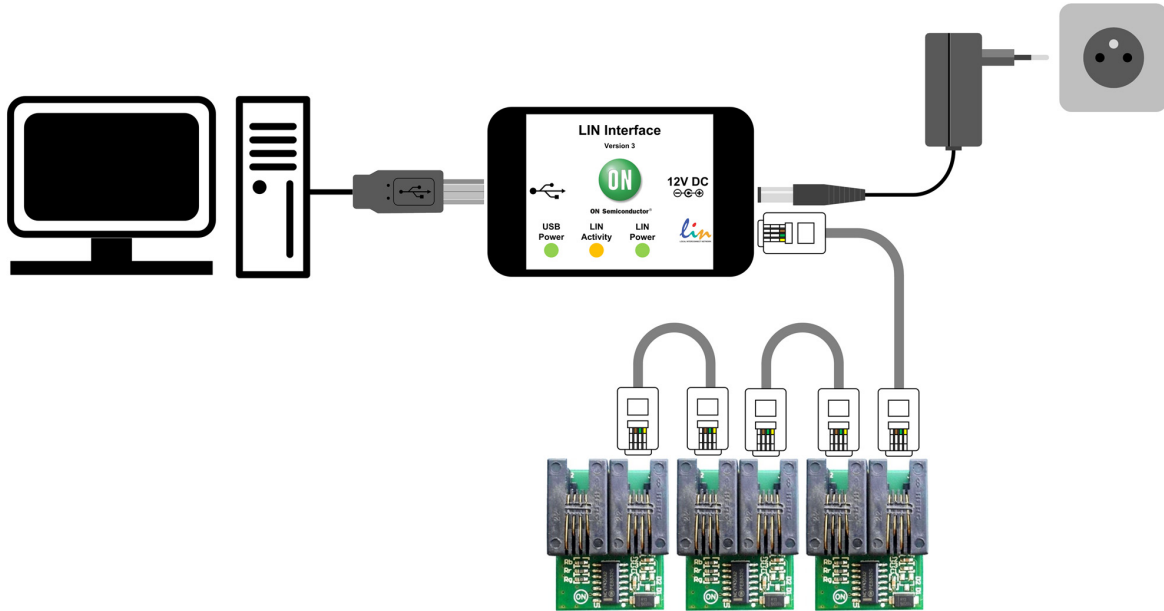

Figure 4. NCV7430 Evaluation Setup Connection (Configuration 1)

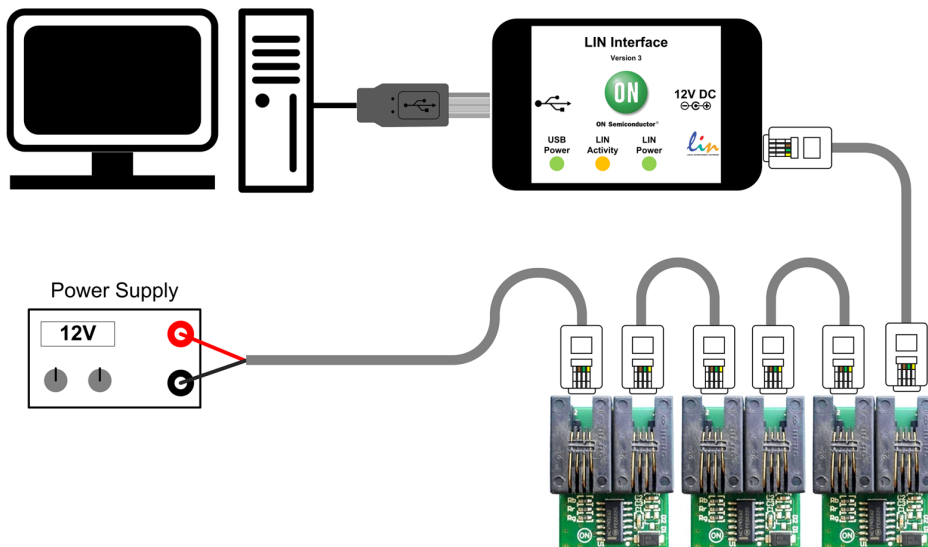

Figure 5. NCV7430 Evaluation Setup Connection (Configuration 2)

NCV7430V1GEVB

4. Run the NCV7430 Evaluation Software.

5. Select one of the nodes from “Nodes” table (detected nodes are highlighted in yellow).

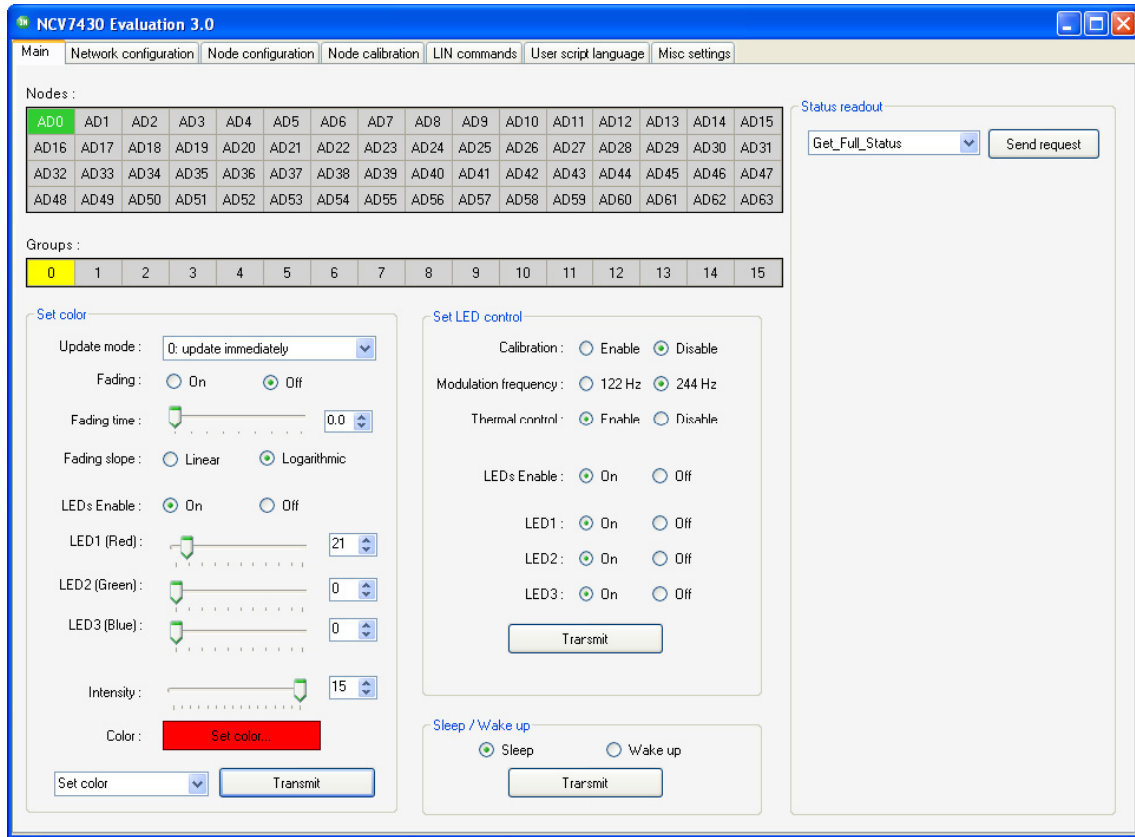

Figure 6. NCV7430 Evaluation Software Preview

6. To switch the LED to On state set the parameters in Set Color group box according to picture below and select Transmit. The color setting can be freely modified. Then set the parameters in Set LED Control group box and select Transmit. These two commands can be sent in any order.

7. LED should be turned on with preset color.

NCV7430 EVALUATION SOFTWARE

Minimum Requirements

Operating system

- Windows XP, SP3 (32/64-bit)
- Windows Vista, SP1 (32/64-bit)
- Windows 7 (32/64-bit)
- Microsoft .NET Framework 4.0

Hardware requirements

- Processor: 1 GHz
- RAM: 512 MB
- Disk Space: 850 MB (32-bit system)
2 GB (64-bit system)

- Monitor resolution: minimum 800x600 pixels
- USB port

(The minimum disk space requirement is based on Microsoft .NET Framework 4.0 system requirements)

Installation Procedure

1. Please check if Microsoft .NET Framework 4.0 is installed on your computer. If not, run **dotNetFx40_Full_setup.exe** prior to the NCV7430 Evaluation software installation.
2. Run **NCV7430 Evaluation Setup.exe** and follow the installation wizard instructions.

NCV7430V1GEVB

Driver Setup

USB drivers should be installed automatically with the software. Once installed, you can plug the LIN Interface into the USB port. The hardware should be installed automatically and following message should be displayed:

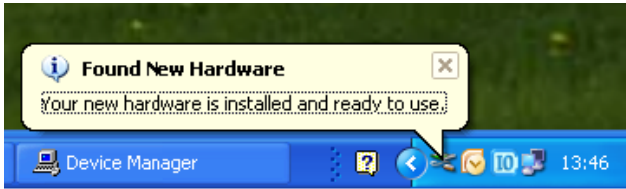

The installation can be checked in Device Manager. When the hardware is connected, you should be able to find *USB Serial Converter A* and *B* in *Universal Serial Bus controllers* group.

In case you encounter any problem with the drivers, try installing the drivers manually. The drivers can be found on <http://www.ftdichip.com/Drivers/D2XX.htm> – D2XX drivers – also available as executable file.

NCV7430 SOFTWARE OVERVIEW

NCV7430 Evaluation is a graphical user interface (GUI) for NCV7430 RGB LED driver. The software provide several screens organized in tab layout.

- Main
- Network Configuration
- Node Configuration
- Node Calibration
- LIN Commands
- User Script Language (USL)

Main Tab

Main tab provides following frames:

Writing Frame	Reading Frame
Set_Color	Get_Full_Status
Set_LED_Control	Get_Status
	Get_LED_Control
	Get_Color
	Get_Actual_Param1
	Get_Actual_Param2

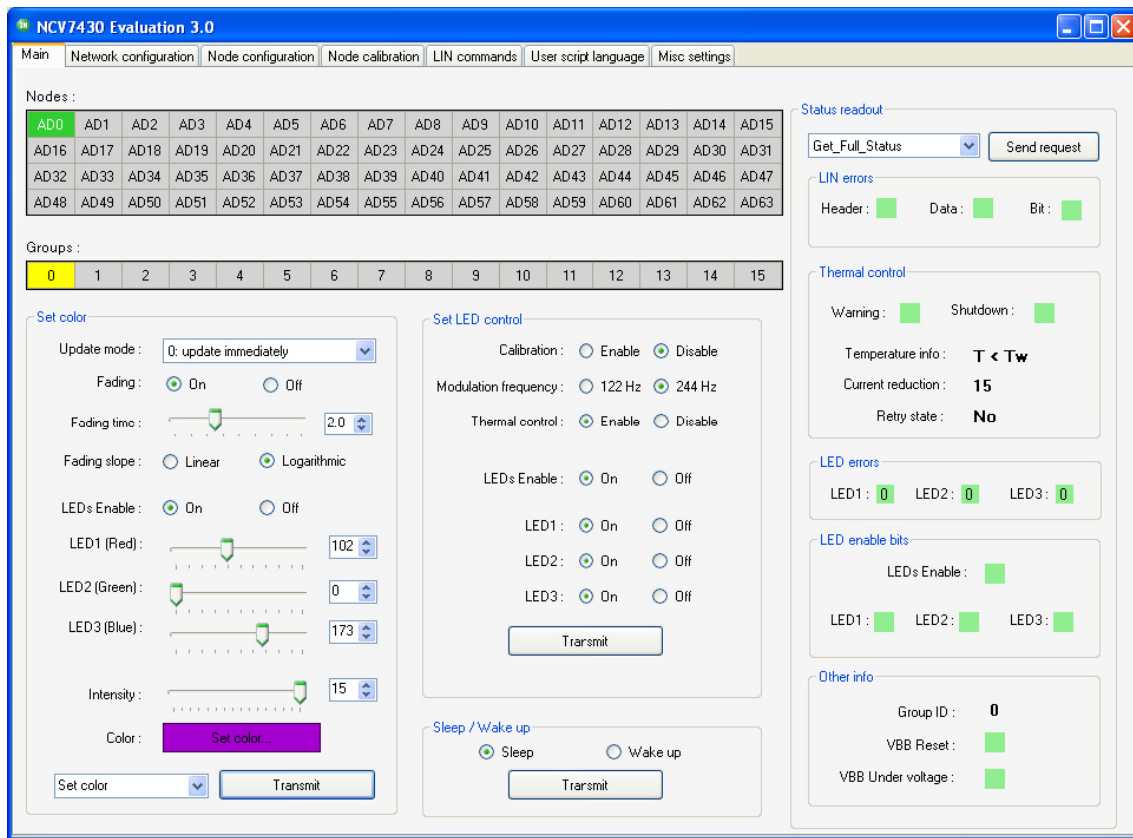

Figure 7. NCV7430 Evaluation – Main Tab

NCV74300V1GEVB

The first step is to select the node, then configure respective frame and click Transmit, or Send Request.

Selecting the Node

The node you want to use can be selected by clicking on its node address (ADx) in the nodes table. You can also select

one of the 16 groups instead of specific node. Only writing frames can be sent to a Group. All the reading frames need to be sent to one specific node.

Nodes :

AD0	AD1	AD2	AD3	AD4	AD5	AD6	AD7	AD8	AD9	AD10	AD11	AD12	AD13	AD14	AD15
AD16	AD17	AD18	AD19	AD20	AD21	AD22	AD23	AD24	AD25	AD26	AD27	AD28	AD29	AD30	AD31
AD32	AD33	AD34	AD35	AD36	AD37	AD38	AD39	AD40	AD41	AD42	AD43	AD44	AD45	AD46	AD47
AD48	AD49	AD50	AD51	AD52	AD53	AD54	AD55	AD56	AD57	AD58	AD59	AD60	AD61	AD62	AD63

Groups :

0	1	2	3	4	5	6	7	8	9	10	11	12	13	14	15
---	---	---	---	---	---	---	---	---	---	----	----	----	----	----	----

Figure 8. Selecting the Node

Enabling the LEDs

The LEDs can be enabled by sending Set_LED_Control command with LEDs Enabled and all the individual LED1, LED2 and LED3 set to On.

Figure 9. Enabling the LEDs

When LEDs Enable is set to On, the individual LED's can be enabled and disabled independently by setting LED1 – LED3 to On/Off. LED Enable status can be checked by sending *Get_Full_Status* frame. Please note that even with LED correctly enabled, you can see no output light in case the LED modulation registers are set to 0.

Setting the Color

LED output color can be set either by Set_Color or Set_Color_Short command.

Once the LED's are enabled, in Set Color Group box:

1. Select Set Color command. (see Figure 10)
2. Set LED's Enable to On.
3. Select any color by setting LED1, LED2 and LED3 modulation values.
4. Select any Intensity.
5. Click on Transmit button.

or

1. Select Set Color Short command. (see Figure 11)
2. Select any color by setting LED1, LED2 and LED3 modulation values.
3. Click on Transmit button.

The required color can be also chosen in a Color dialog (see Figure 12). To open the CIE Color Diagram click on the colored "Set color..." field in Set Color group box.

Figure 10. Set Color Command

Figure 11. Set Color Short Command

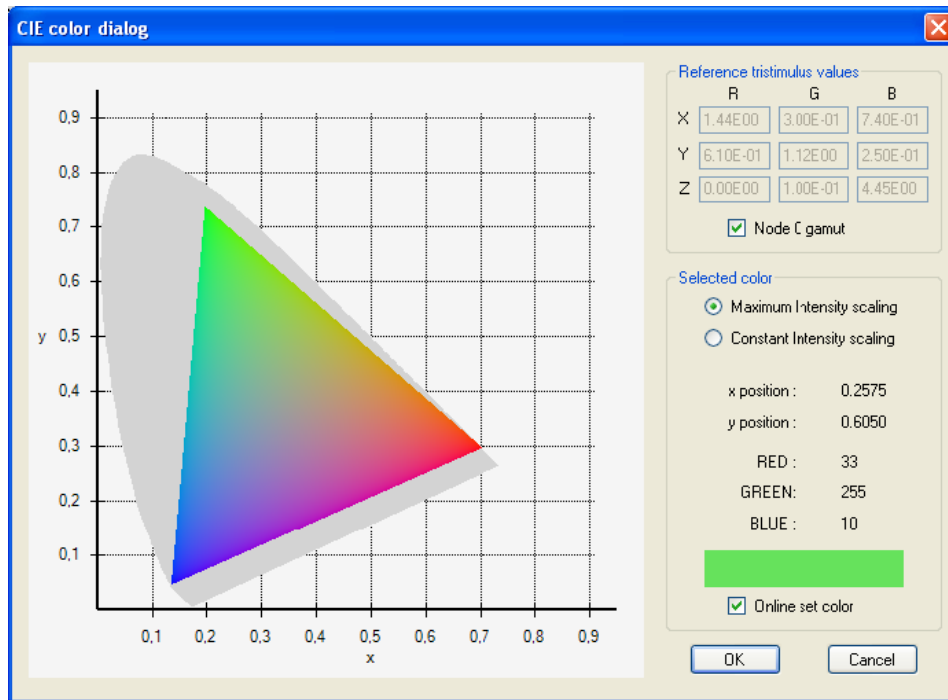

NOTE: With selecting "Online set color", the LED module follows the color chosen in the diagram.

Figure 12. Color Dialog

Setting the Intensity

The overall intensity of the LEDs is programmable with a four bit scaling factor that is applied over the LED modulation. The scaling is linear (factor $n/16$, $n = 15$ is mapped to 1.0). LED intensity can be set either by Set_Color or Set_Intensity command.

In Set Color Group box:

1. Select Set Color Command or Set intensity command.
2. Set Intensity level.
3. Click to Transmit.

Theatre Dimming Function

The NCV7430 has a fading function to give a theater dimming effect when changing color and/or intensity settings. The effect presents itself as a smooth transition between colors, or increases or decreases in intensity.

The fading effect can be enabled by setting Set_Color command (see Figure 13):

In Set Color Group box:

1. Set Fading to On.
2. Select any Fading Time.
3. Choose Linear or Logarithmic fading.
4. Click on Transmit.
5. With enabled fading function, Change Color or intensity.

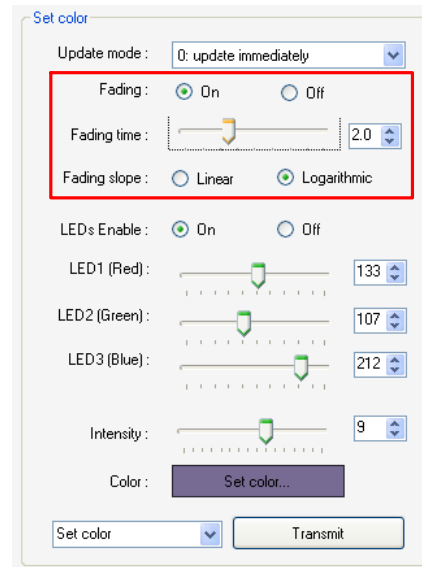

Figure 13. Set_Color Command

The fading time can be also set by Set_intensity command (see Figure 14).

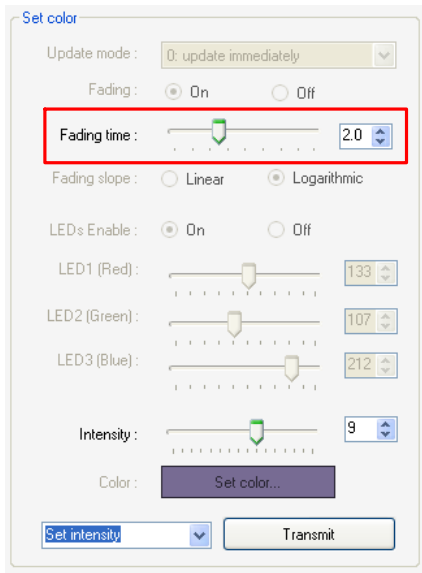

Figure 14. Set_Intensity Command

LED Modulation Frequency

The LED modulation frequency can be chosen to be 122 Hz or 244 Hz.

In Set LED Control Group box

1. Select 122 Hz or 244 Hz PWM Frequency and Click Transmit.
2. The PWM frequency can be measured by oscilloscope on LEDxC or LEDxR pin.



Figure 15. LED Modulation Frequency

LED Update Modes

The Set_Color Command can be sent in following update modes:

- Immediate Update
- Store and Do Not Update
- Update to the Already Stored Values
- Discard

When “Immediate update” mode is selected, the changed are applied right after the Set_Color command is sent.

In “Store and do not update” mode, the values selected in Set Color Group box are stored in internal memory and are applied only when the Set_Color Command is sent in “Update to the already stored values” mode.

Sleep Mode and Wakeup

In sleep mode, LEDs are turned OFF and the VBIAS output is brought to 0 V, turning OFF the optional bypass transistor. The internal circuitry of the NCV7430, including the band gap reference, internal oscillator and current

sources are put in low power mode and the internal registers are reset. In Sleep mode the total battery current consumption is reduced.

To bring the NCV7430 to the Sleep mode, select Sleep in the Sleep/Wakeup Group box and click Transmit.

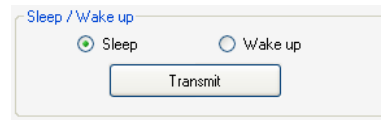

Figure 16. Sleep/Wakeup Mode

The NCV7430 wakes up from sleep after detection of a transition of LIN recessive state to dominant state followed by a dominant level for a time period of t_{wake} and again a rising edge from dominant to recessive. Select Wake-up in the Sleep/Wakeup Group box and click Transmit. As internal register are reset after entering Sleep mode, the LED’s are not enabled after Wake-up. Set_Color and Set_LED_Control frames are required after Wakeup to set LED’s on again.

Network Configuration Tab

This screen provides network scanning function and Groups configuration.

Scan Network

Whenever new node is connected to the network, the network scan should be perform in order to detect all the available node addresses.

Use the Scan Network button to perform the network scan. It can take few seconds to complete this action. Once completed, all the detected nodes are listed in the Nodes table.

Groups Configuration – Group Address

Each node can be added to one specific Group. Choose the desired group with right mouse button click, select *Add nodes* menu and select the node you want to add to this group or simply select one of the nodes and then click the new group. The changes are not applied immediately, but will appear in the *List of Changes* on the right side. User can cancel any prepared change by clicking with right mouse button in the List of changes table and selecting *Cancel Change*. Once all the needed changes are prepared, click on the Apply changes button to program the Group Address OTP’s.

In the Figure 17, three nodes are attached to the network. AD0 and AD2 belongs to Group0 and AD3 belongs to Group3.

To add Node AD2 to Group 5:

1. Select Node AD2.
2. Click the Group 5.
3. The modification will appear in the List of changes.
4. Click the *Apply changes* button to write the new setting to the device.

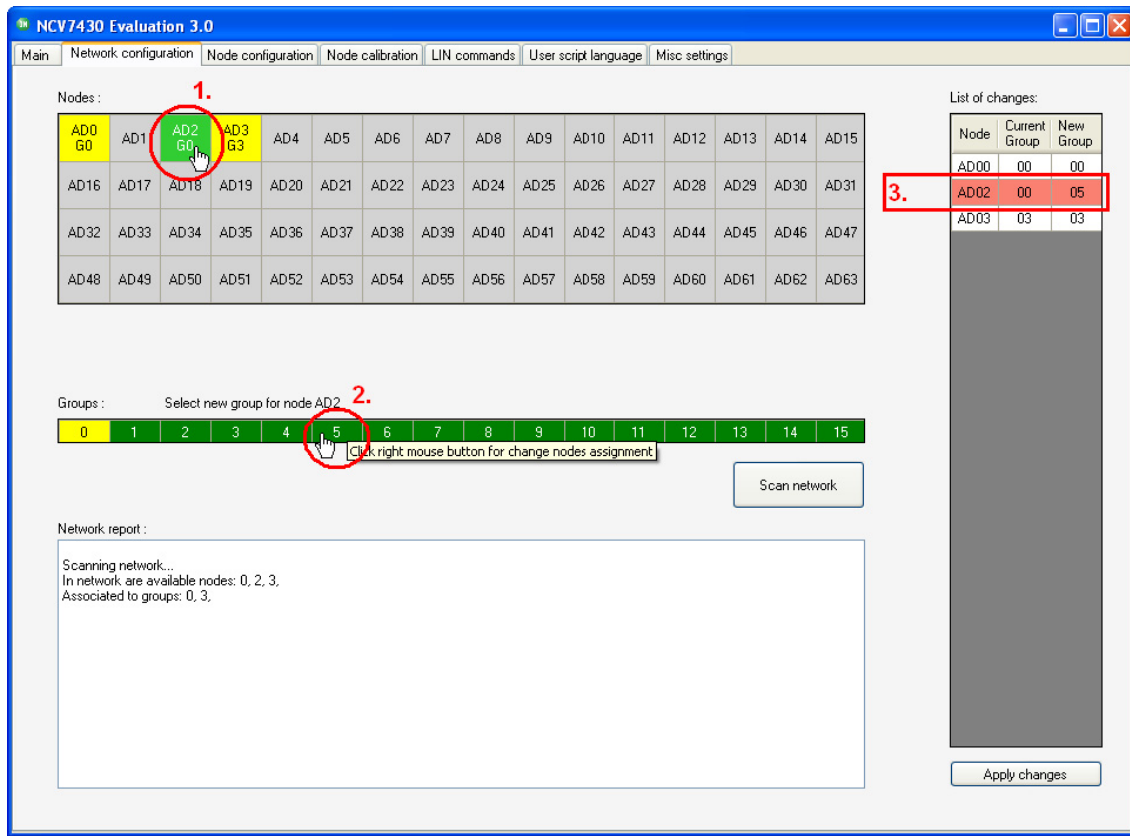

Figure 17. NCV7430 Evaluation – Network Configuration Tab

Node Configuration Tab

OTP's Programming

All OTP's except Group Address can be zapped from Node Configuration Tab. Group Address OTP can be zapped from Network Configuration tab.

Node Address (NAD)

Node Address can be set by Node Address Programming command on Node Configuration (see Figure 18).

To change the node default address:

1. Select appropriate node from the list.
2. Select the new NAD address in "Node address programming" Groupbox. The valid addresses are marked in green. (New address AD4 selected to be programmed to Node AD0 in the picture below)
3. Click Program New Address.

After programming, the network is automatically updated.

Node Address programming can be repeated while LockBit1 is not zapped. Each bit can be programmed only once (programming means setting from 1 to 0). E.g. it is possible to change address from 1 to 3 but not to 2.

Group Address

Group Address can be configured in *Network Configuration* Tab.

Node Calibration Tab

This part can be used to calculate the reference matrix and calibration factors and to write these factors to OTP shadow registers (see Figure 19).

1. Measure LED's.
2. Find the smallest triangle.
3. Calculate calibration factors.
4. Select node for calibration.
5. Set Calibration factors according to calculated values.
6. Click Write.
7. Enable calibration in "Main" tab.

For LED color calibration a measurement of XYZ tristimulus value for each individual LED is needed.

Use NCV7430 Calibration Calculator Excel file to calculate the calibration constants or to calculate the Reference Tristimulus values (the smallest triangle).

Then set the Calibration Factors in Node Calibration tab according to calculated values and click Write. The Calibration Factors can be also calculated from Reference and measured values if these are available. The Calibration values are stored in Shadow Registers and result of the calibration can be checked by enabling calibration by Set_LED_Control command.

NCV7430V1GEVB

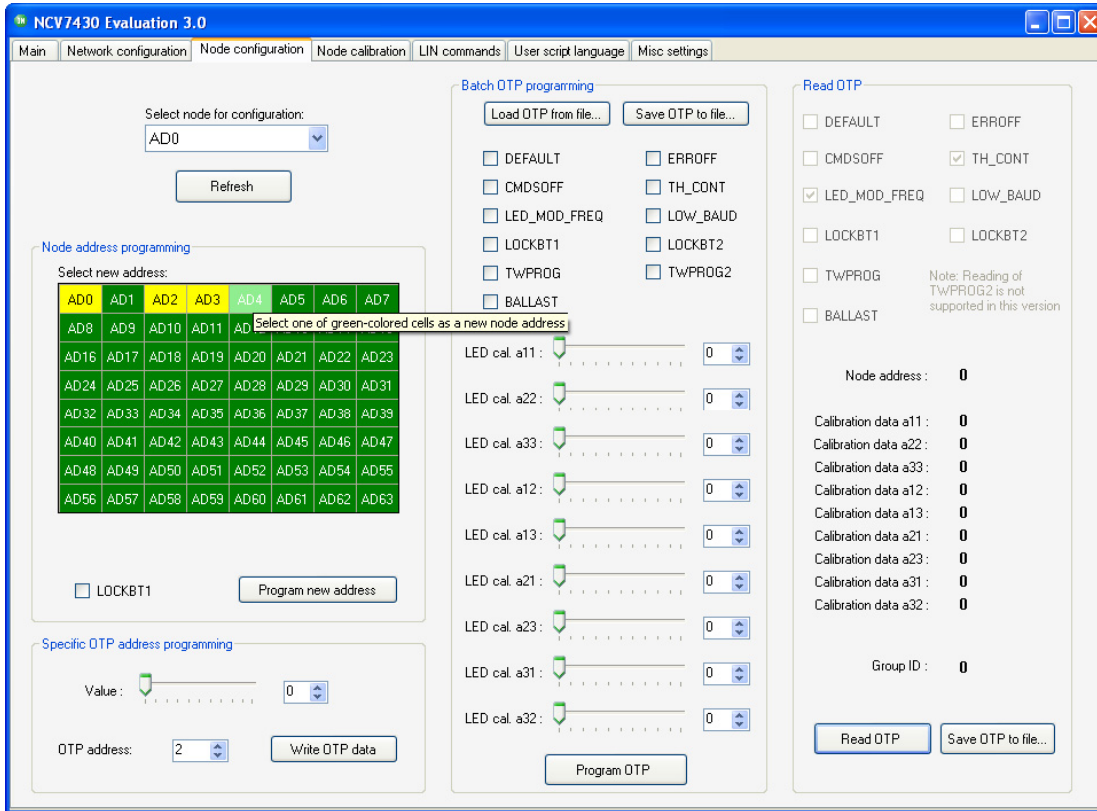

Figure 18. NCV7430 Evaluation – Node Configuration Tab

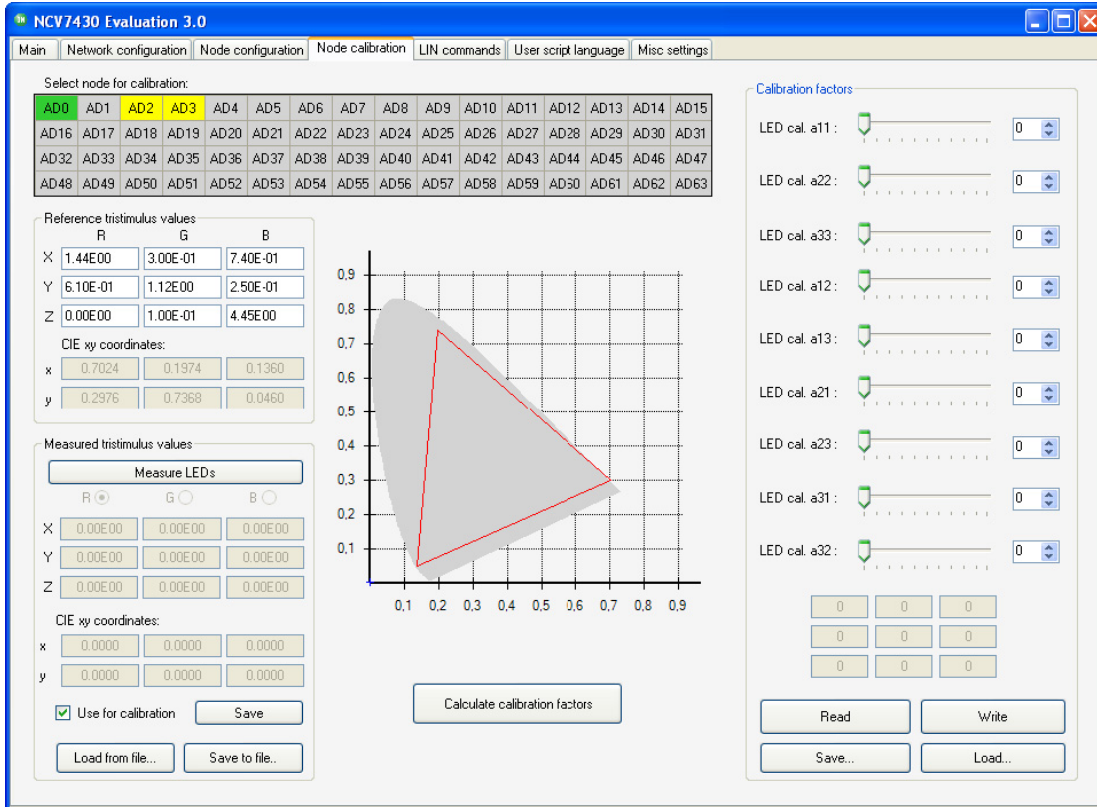

Figure 19. NCV7430 Evaluation – Node Calibration Tab

NCV7430V1GEVB

LIN Commands Tab

The LIN commands tab has two functions. It monitors all the LIN bus traffic and allows sending a custom frame. Transmitted or received commands are listed in a table together with a time stamp and description of the frame.

In the Frame Creator group box, fill all the necessary fields and click the Data transfer button to send the custom frame.

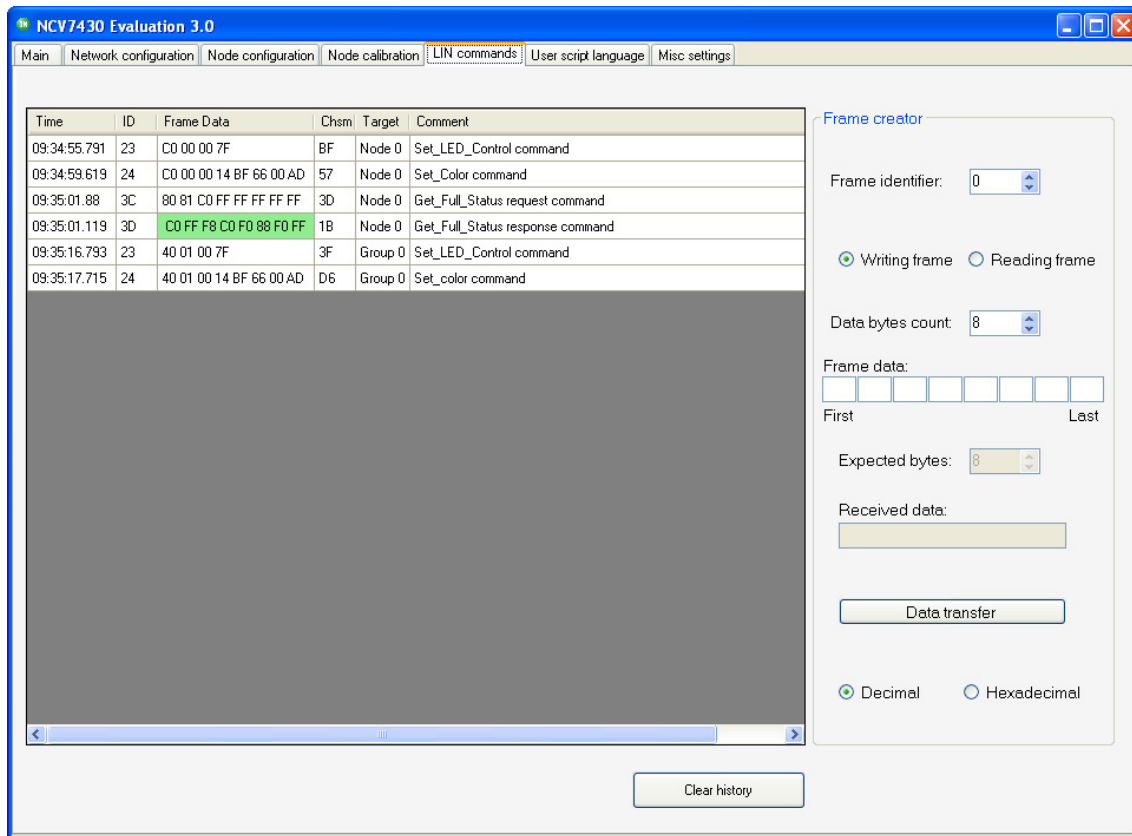

Figure 20. NCV7430 Evaluation – LIN Commands Tab

NCV7430V1GEVB

User Script Language Tab

User Script Language is a simple tool for automatic execution of basic functions of NCV7430 LED Driver. You can create your own script in built-in editor using supported functions, and one-row comments starting with `"/"`. This USL is not case-sensitive. For correct syntax please see description of supported functions or code example.

The cripts can be saved or opened to/from text file. Files created in built-in editor are saved with `*.usl` extension.

Supported Functions

- **Set_Color** function – To send writing frame Set_Color
- **Set_LED_Control** function – To send writing frame Set_LED_Control
- **Delay** function – To define time space between two commands
- **Custom Frame** function – To send arbitrary Lin frame
- **Repeat** function – Allows to create loops

```

/*****
/* Delay(d)
/*   d - time delay in milliseconds
/*****
Delay(3000)    // time delay of 3 seconds
/*****
/* Set_Color(target,R,G,B,[intensity],[fading enable],[fading slope],[LEDs enable],[fading time],[update mode])
/*   target      - node address "Nxx" (0 < xx < 64)
/*               - group ID "Gxx" (0 < xx < 16)
/*               - group mask "GM0xXXXX" (Hex number 0x0000 - 0xFFFF)
/*   R,G,B       - color modulation values, integer number (0 - 255)
/*   intensity   - intensity factor, integer number (0-15), optional (default: 15)
/*   fading enable - Boolean value (true or false), optional (default: false)
/*   fading slope - Boolean value (true or false), optional (default: false)
/*   LEDs enable - Boolean value (true or false), optional (default: true)
/*   fading time  - fading time in seconds, double number (0.0 - 6.3), optional (default: 0.0)
/*   update mode  - update mode, integer number (0-3), optional (default: 0)
/*****
Set_Color(n15,10,200,220,15,true,false,true,2.0,0)    // set color applied on node 15
Set_Color(gm0xFF00,10,200,220,15,true,false,true,2.0,0) // set color applied to groups 8 to 15
/*****
/* Set_LED_Control(target, LEDs enable,[LED1 enable],[LED2 enable],[LED3 enable],[cal. enable])
/*   target      - node address "Nxx" (0 < xx < 64)
/*               - group ID "Gxx" (0 < xx < 16)
/*               - group mask "GM0xXXXX" (Hex number 0x0000 - 0xFFFF)
/*   LEDs enable - Boolean value (true or false)
/*   LED1 enable - Boolean value (true or false), optional (default: true)
/*   LED2 enable - Boolean value (true or false), optional (default: true)
/*   LED3 enable - Boolean value (true or false), optional (default: true)
/*   cal. enable - Boolean value (true or false), optional (default: false)
/*****
Set_LED_Control(g10,true)    // set LED control applied on group 10
Set_LED_Control(gm0x00FF,true) // set LED control applied on groups 0 to 7
/*****
/* Custom_Frame(Frame ID, Frame data)
/*   Frame ID   - Frame ID without parity in decimal format (0-63)
/*   Frame data - 2 to 8 comma-separated decimal values as a frame bytes in range (0-255)
/*****
Custom_Frame(25,100,255,0,10) // Frame with ID= 25 and four data bytes
/*****
/* Repeat(n) - end
/*   n - number of repetitions (Set n = -1 for infinite loop)
/*****
Repeat(-1)    // start of infinite loop
  Set_LED_Control(g10,true)
  Repeat(5)    // repeat 5 times following code
    Set_Color(n5,100,0,0)
    Delay(1000)
    Set_Color(n5,0,100,0)
    Delay(1000)
  end    // end of inner repeat section
  Set_LED_Control(g10,false)
  Delay(500)
end    // end of infinite loop

```

NOTE: The built-in text editor supports Find (CTRL+F) and Replace (CTRL+H) functions.

NCV74300V1GEVB

Misc Settings Tab

The last Misc settings tab is used to set LIN baud-rate and additional OTP programming actions:

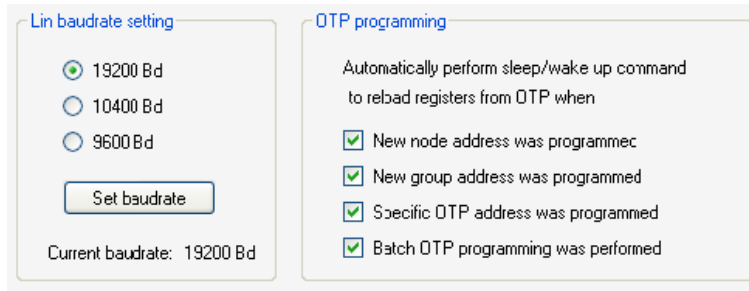

Figure 21. Misc Settings

SCHEMATIC

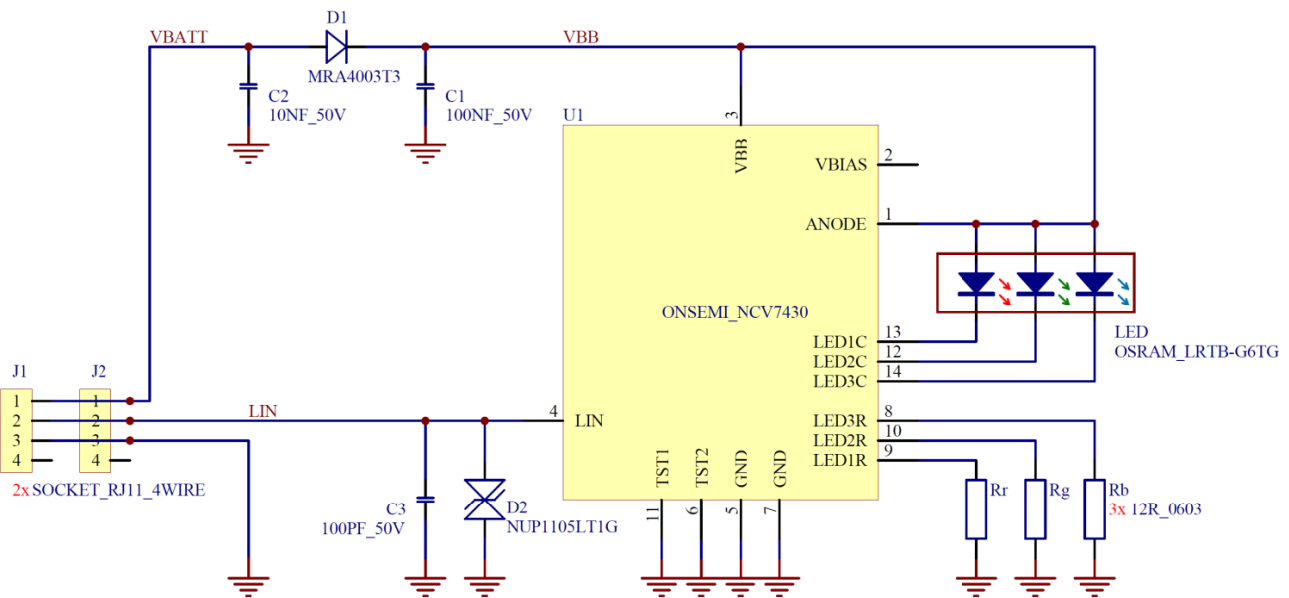

Figure 22. NCV7430 Schematic

Table 4. NCV74300V1GEVB BILL OF MATERIALS

Designator	Qty.	Description	Value	Tolerance	Footprint	Manufacturer	Manufacturer Part Number	Substitution Allowed
C1	1	VBB Filter Capacitor	100 nF, 50 V	±10%	0603	Murata	GCM188R71H104KA57D	Yes
C2	1	VBAT Filter Capacitor	10 nF, 50 V	±10%	0603	Murata	GCM188R71H103KA37D	Yes
C3	1	LIN Filter Capacitor	100 pF, 50 V	±5%	0603	Murata	GCM1885C1H101JA16D	Yes
D1	1	Reverse Battery Diode			SMA	ON Semiconductor	MRA4003T3G	Yes
D2	1	LIN Bus Protector			SOT23	ON Semiconductor	NUP1105L	Yes
J1, J2	2	RJ11 RIGHT ANGLE SOCKET			FCL_87180-044LF	FCI	87180-044LF	Yes
LED	1	RGB LED			LRTB_G6TG	OSRAM	LRTBG6TG	Yes
Rr, Rg, Rb	3	LED Current Programming Resistors	12 Ω	±1%	0603	MULTICOMP	MC 0.063W 0603 1% 12R	Yes
U1	1	NCV7430 SOIC-14			SOIC-14	ON Semiconductor	NCV7430D20G	No

NCV7430V1GEVB

PCB DRAWINGS

Assembly Drawings

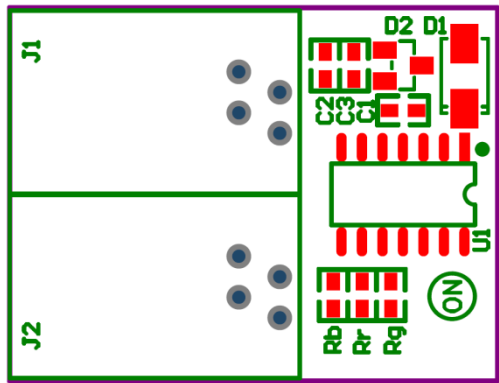

Figure 23. NCV7430 EVB PCB Top Assembly Drawing

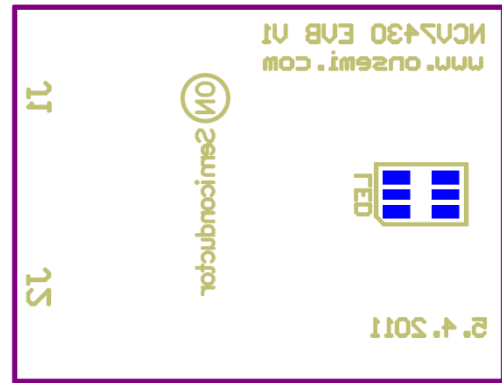
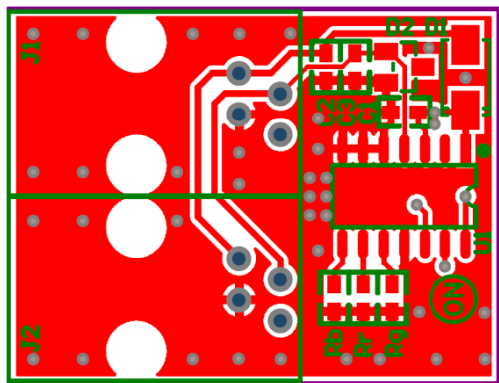



Figure 24. NCV7430 EVB PCB Bottom Assembly Drawing

Composite Drawings



ON Semiconductor and  are registered trademarks of Semiconductor Components Industries, LLC (SCILLC). SCILLC owns the rights to a number of patents, trademarks, copyrights, trade secrets, and other intellectual property. A listing of SCILLC's product/patent coverage may be accessed at www.onsemi.com/site/pdf/Patent-Marking.pdf. SCILLC reserves the right to make changes without further notice to any products herein. SCILLC makes no warranty, representation or guarantee regarding the suitability of its products for any particular purpose, nor does SCILLC assume any liability arising out of the application or use of any product or circuit, and specifically disclaims any and all liability, including without limitation special, consequential or incidental damages. "Typical" parameters which may be provided in SCILLC data sheets and/or specifications can and do vary in different applications and actual performance may vary over time. All operating parameters, including "Typicals" must be validated for each customer application by customer's technical experts. SCILLC does not convey any license under its patent rights nor the rights of others. SCILLC products are not designed, intended, or authorized for use as components in systems intended for surgical implant into the body, or other applications intended to support or sustain life, or for any other application in which the failure of the SCILLC product could create a situation where personal injury or death may occur. Should Buyer purchase or use SCILLC products for any such unintended or unauthorized application, Buyer shall indemnify and hold SCILLC and its officers, employees, subsidiaries, affiliates, and distributors harmless against all claims, costs, damages, and expenses, and reasonable attorney fees arising out of, directly or indirectly, any claim of personal injury or death associated with such unintended or unauthorized use, even if such claim alleges that SCILLC was negligent regarding the design or manufacture of the part. SCILLC is an Equal Opportunity/Affirmative Action Employer. This literature is subject to all applicable copyright laws and is not for resale in any manner.

PUBLICATION ORDERING INFORMATION

LITERATURE FULFILLMENT:

Literature Distribution Center for ON Semiconductor
P.O. Box 5163, Denver, Colorado 80217 USA
Phone: 303-675-2175 or 800-344-3860 Toll Free USA/Canada
Fax: 303-675-2176 or 800-344-3867 Toll Free USA/Canada
Email: orderlit@onsemi.com

N. American Technical Support: 800-282-9855 Toll Free
USA/Canada
Europe, Middle East and Africa Technical Support:
Phone: 421 33 790 2910
Japan Customer Focus Center
Phone: 81-3-5817-1050

ON Semiconductor Website: www.onsemi.com

Order Literature: <http://www.onsemi.com/orderlit>

For additional information, please contact your local
Sales Representative