

MSR860G, MSRF860G

Switch-mode Soft Recovery Power Rectifiers Plastic TO-220 Package

These state-of-the-art devices are designed for use as free wheeling diodes in variable speed motor control applications and switching power supplies.

Features

- Soft Recovery with Guaranteed Low Reverse Recovery Charge (Q_{RR}) and Peak Reverse Recovery Current (I_{RRM})
- 150°C Operating Junction Temperature
- Epoxy meets UL 94 V-0 @ 0.125 in
- Low Forward Voltage
- Low Leakage Current
- These are Pb-Free Devices

Mechanical Characteristics:

- Case: Epoxy, Molded
- Weight: 1.9 Grams (Approximately)
- Finish: All External Surfaces Corrosion Resistant and Terminal Leads Readily Solderable
- Lead Temperature for Soldering Purposes: 260°C Max. for 10 Seconds

MAXIMUM RATINGS

Rating	Symbol	Value	Unit
Peak Repetitive Reverse Voltage Working Peak Reverse Voltage DC Blocking Voltage	V_{RRM} V_{RWM} V_R	600	V
Average Rectified Forward Current (Rated V_R , $T_C = 125^\circ\text{C}$)	I_O	8.0	A
Peak Repetitive Forward Current (Rated V_R , Square Wave, 20 kHz, $T_C = 125^\circ\text{C}$)	I_{FRM}	16	A
Non-Repetitive Peak Surge Current (Surge Applied at Rated Load Conditions Halfwave, Single Phase, 60 Hz)	I_{FSM}	100	A
Storage/Operating Case Temperature	T_{stg} , T_C	-65 to +150	°C
Operating Junction Temperature	T_J	-65 to +150	°C

THERMAL CHARACTERISTICS

Parameter	Symbol	Value	Unit
MSR860G Thermal Resistance, Junction-to-Case Thermal Resistance, Junction-to-Ambient	$R_{\theta JC}$ $R_{\theta JA}$	1.6 72.8	°C/W
MSRF860G Thermal Resistance, Junction-to-Case Thermal Resistance, Junction-to-Ambient	$R_{\theta JC}$ $R_{\theta JA}$	4.75 75	°C/W

Stresses exceeding those listed in the Maximum Ratings table may damage the device. If any of these limits are exceeded, device functionality should not be assumed, damage may occur and reliability may be affected.



ON Semiconductor®

<http://onsemi.com>

SOFT RECOVERY POWER RECTIFIER 8.0 AMPERES, 600 VOLTS

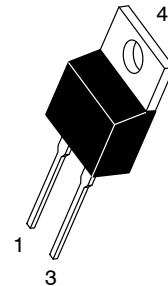
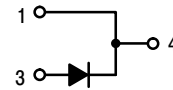

TO-220AC
CASE 221B
STYLE 1

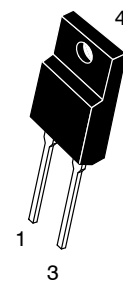

TO-220 FULLPAK
CASE 221AG
STYLE 1

MARKING DIAGRAMS

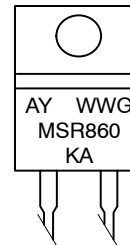

- A = Assembly Location
- Y = Year
- WW = Work Week
- G = Pb-Free Package
- KA = Diode Polarity

ORDERING INFORMATION

Device	Package	Shipping
MSR860G	TO-220AC (Pb-Free)	50 Units / Rail
MSRF860G	TO-220FP (Pb-Free)	50 Units / Rail

MSR860G, MSRF860G

ELECTRICAL CHARACTERISTICS

Characteristic	Symbol	Value		Unit
Maximum Instantaneous Forward Voltage ($I_F = 8.0\text{ A}$) (Note 1) Maximum Typical	V_F	$T_J = 25^\circ\text{C}$	$T_J = 150^\circ\text{C}$	V
		1.7 1.4	1.3 1.1	
Maximum Instantaneous Reverse Current ($V_R = 600\text{ V}$) Maximum Typical	I_R	$T_J = 25^\circ\text{C}$	$T_J = 150^\circ\text{C}$	μA
		10 2.0	1000 80	
Maximum Reverse Recovery Time (Note 2) ($V_R = 400\text{ V}$, $I_F = 8.0\text{ A}$, $di/dt = 200\text{ A}/\mu\text{s}$) Maximum Typical	t_{rr}	$T_J = 25^\circ\text{C}$	$T_J = 125^\circ\text{C}$	ns
		120 95	190 125	
Typical Recovery Softness Factor ($V_R = 400\text{ V}$, $I_F = 8.0\text{ A}$, $di/dt = 200\text{ A}/\mu\text{s}$)	$s = t_b/t_a$	2.5	3.0	
Maximum Peak Reverse Recovery Current ($V_R = 400\text{ V}$, $I_F = 8.0\text{ A}$, $di/dt = 200\text{ A}/\mu\text{s}$)	I_{RRM}	5.8	8.3	A
Maximum Reverse Recovery Charge ($V_R = 400\text{ V}$, $I_F = 8.0\text{ A}$, $di/dt = 200\text{ A}/\mu\text{s}$)	Q_{RR}	350	700	nC

Product parametric performance is indicated in the Electrical Characteristics for the listed test conditions, unless otherwise noted. Product performance may not be indicated by the Electrical Characteristics if operated under different conditions.

1. Pulse Test: Pulse Width $\leq 380\ \mu\text{s}$, Duty Cycle $\leq 2\%$
2. T_{RR} measured projecting from 25% of I_{RRM} to zero current

TYPICAL ELECTRICAL CHARACTERISTICS

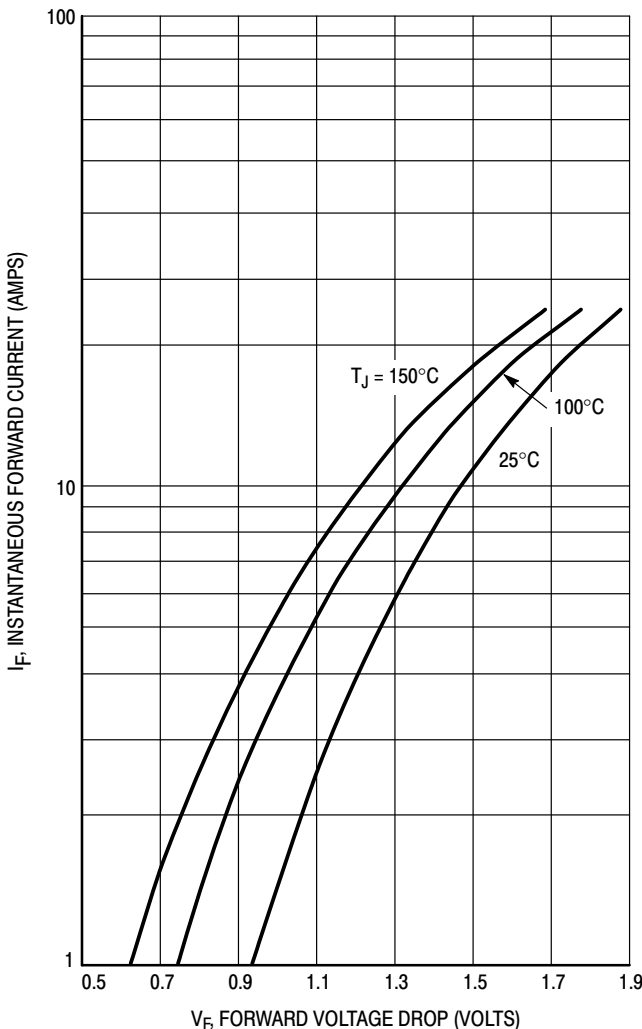

Figure 1. Typical Forward Voltage

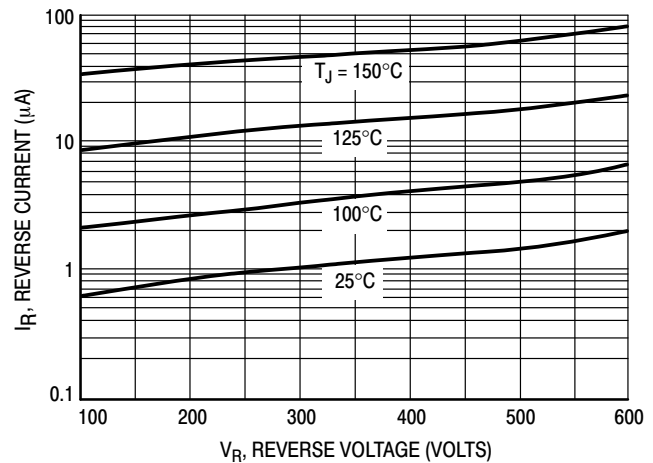

Figure 2. Typical Reverse Current

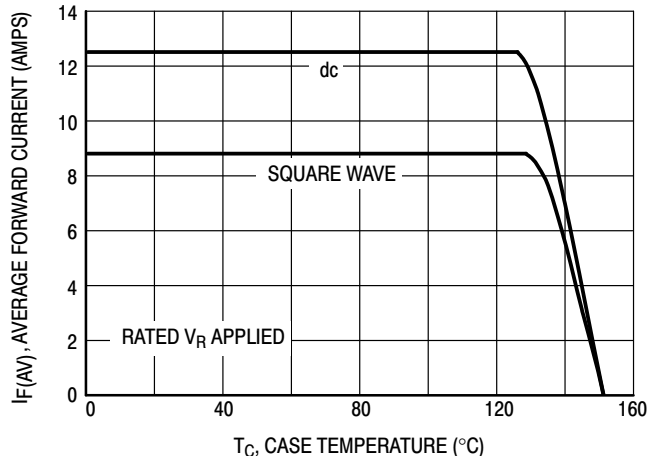

Figure 3. Current Derating, Case

MSR860G, MSRF860G

TYPICAL ELECTRICAL CHARACTERISTICS

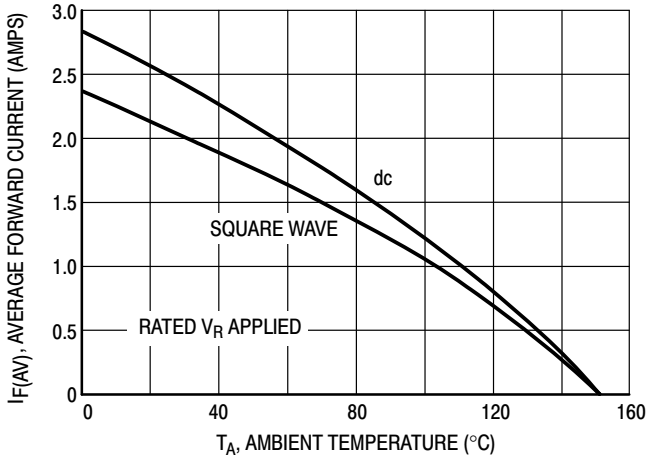

Figure 4. Current Derating, Ambient

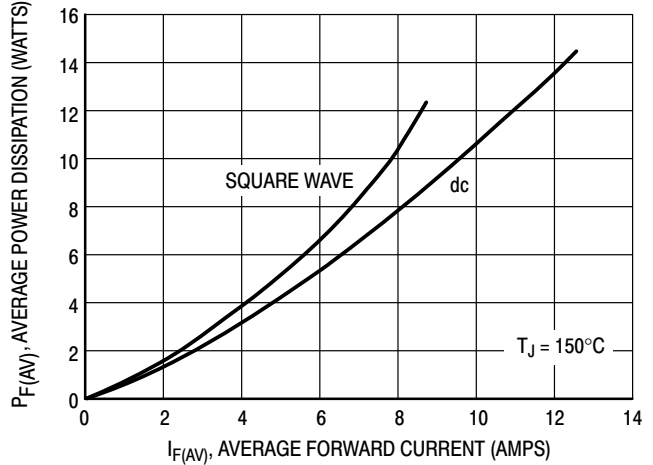

Figure 5. Power Dissipation

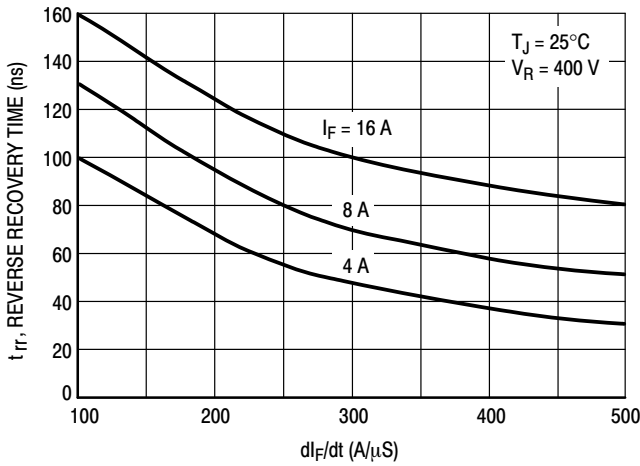

Figure 6. Typical Reverse Recovery Time

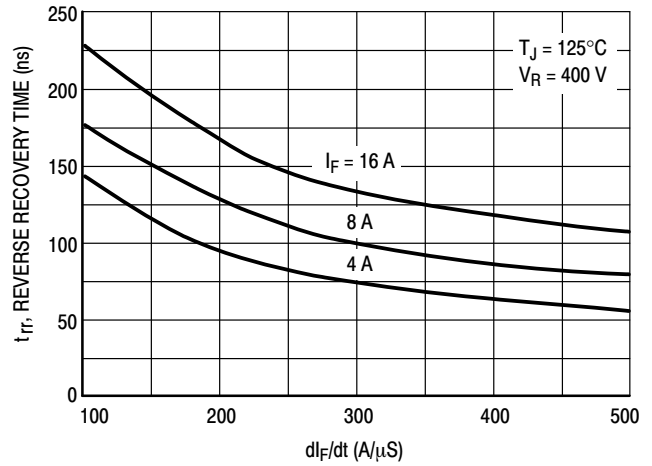

Figure 7. Typical Reverse Recovery Time

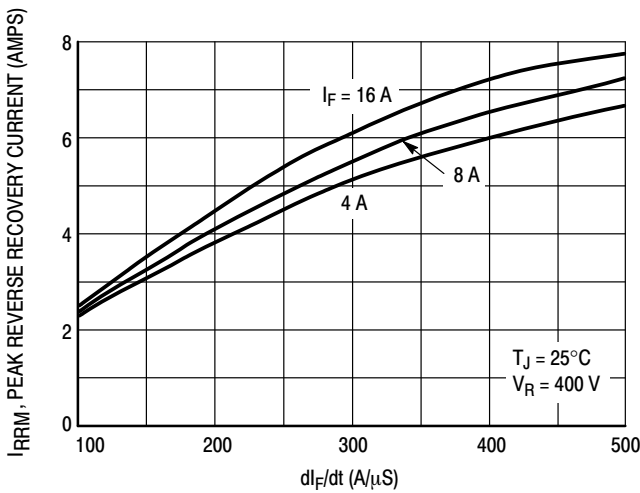

Figure 8. Typical Peak Reverse Recovery Current

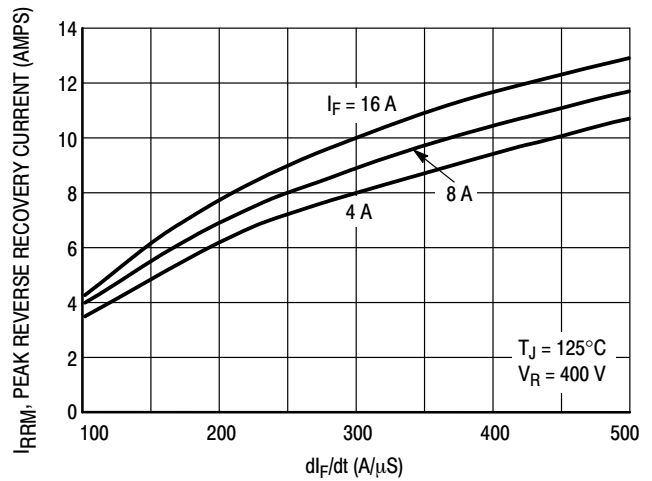

Figure 9. Typical Peak Reverse Recovery Current

MSR860G, MSRF860G

TYPICAL ELECTRICAL CHARACTERISTICS

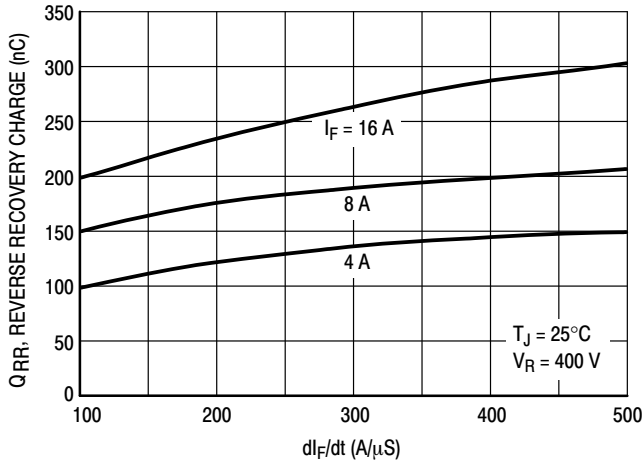

Figure 10. Typical Reverse Recovery Charge

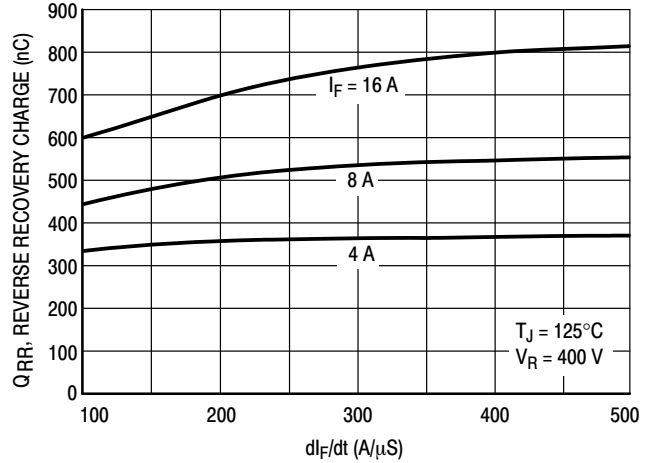

Figure 11. Typical Reverse Recovery Charge

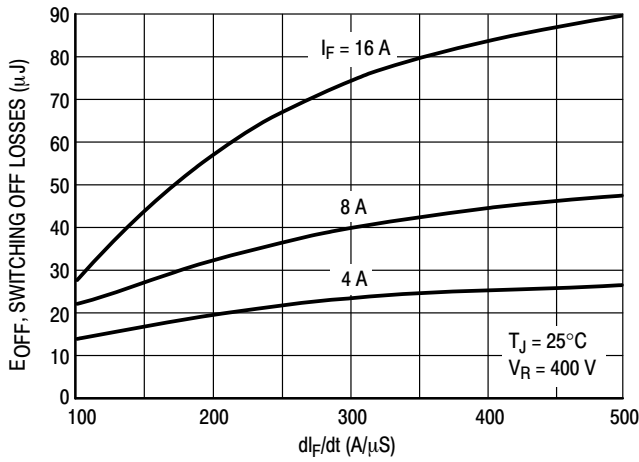

Figure 12. Typical Switching Off Losses

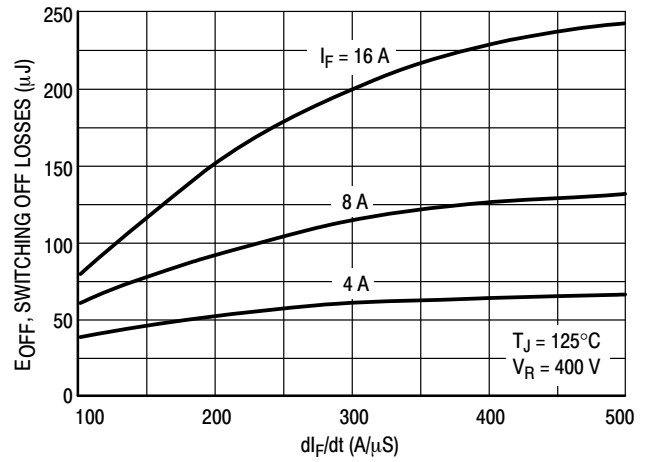

Figure 13. Typical Switching Off Losses

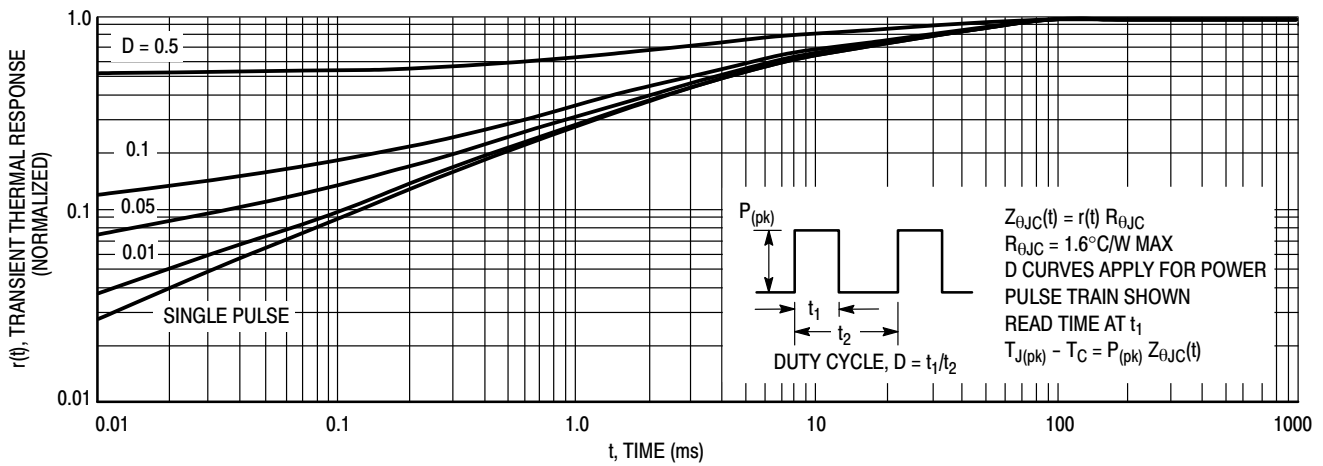

Figure 14. Thermal Response (MSR860)

MSR860G, MSRF860G

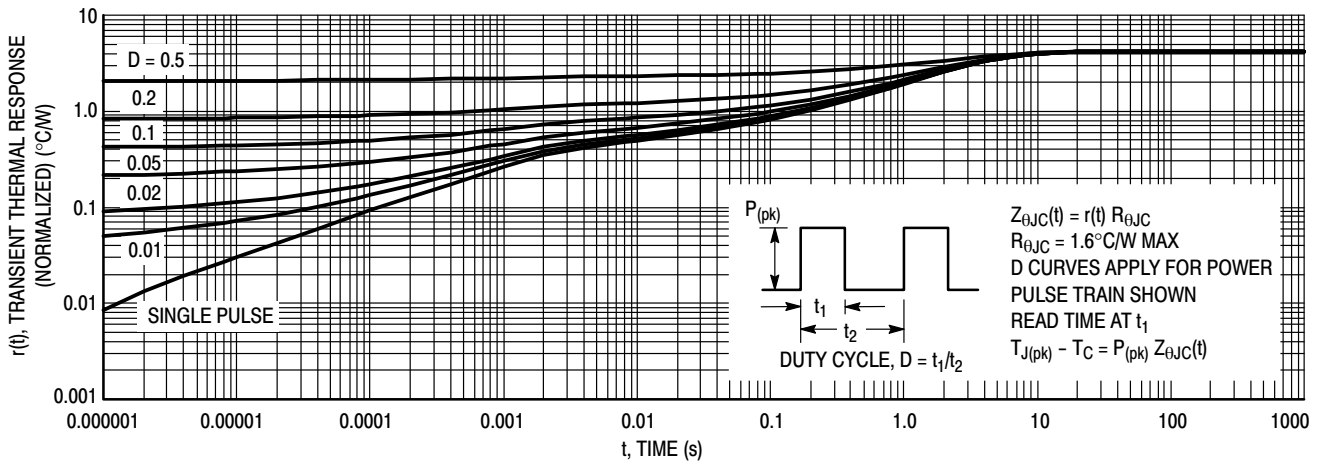

Figure 15. Thermal Response, (MSRF860) Junction-to-Case ($R_{\theta JC}$)

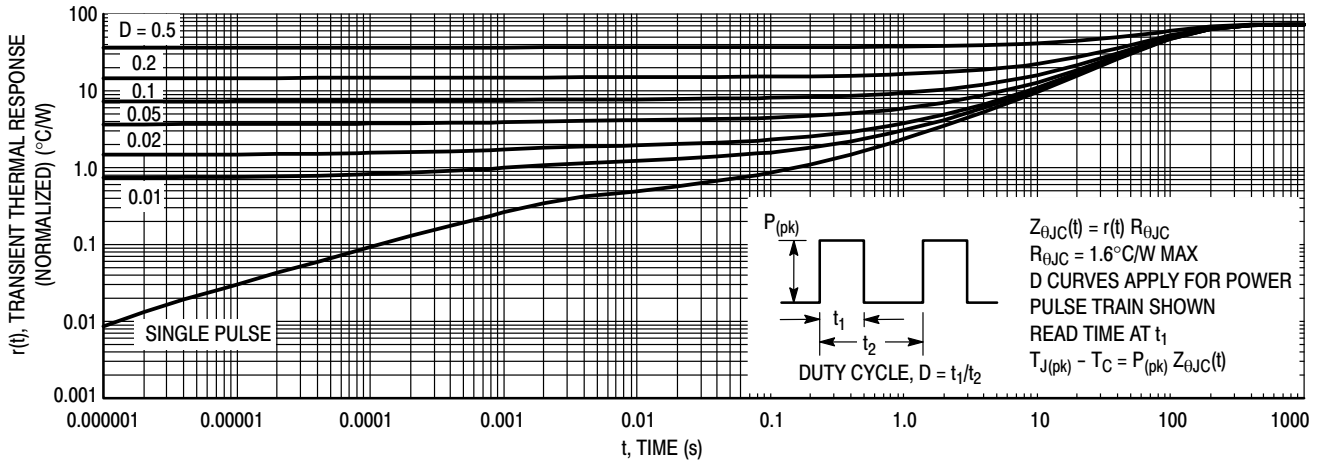
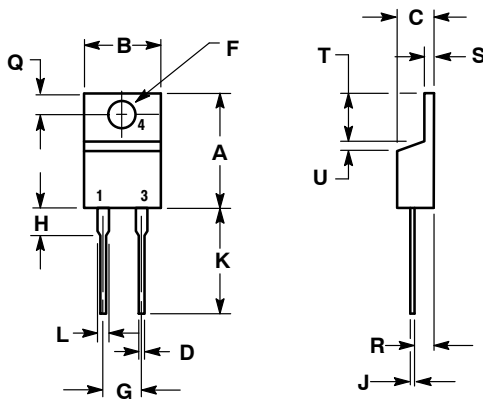

Figure 16. Thermal Response, (MSRF860) Junction-to-Ambient ($R_{\theta JA}$)

MSR860G, MSRF860G

PACKAGE DIMENSIONS

TO-220 TWO-LEAD CASE 221B-04 ISSUE F



- NOTES:
1. DIMENSIONING AND TOLERANCING PER ANSI Y14.5M, 1982.
2. CONTROLLING DIMENSION: INCH.

DIM	INCHES		MILLIMETERS	
	MIN	MAX	MIN	MAX
A	0.595	0.620	15.11	15.75
B	0.380	0.405	9.65	10.29
C	0.160	0.190	4.06	4.82
D	0.025	0.039	0.64	1.00
F	0.142	0.161	3.61	4.09
G	0.190	0.210	4.83	5.33
H	0.110	0.130	2.79	3.30
J	0.014	0.025	0.36	0.64
K	0.500	0.562	12.70	14.27
L	0.045	0.060	1.14	1.52
Q	0.100	0.120	2.54	3.04
R	0.080	0.110	2.04	2.79
S	0.045	0.055	1.14	1.39
T	0.235	0.255	5.97	6.48
U	0.000	0.050	0.000	1.27

- STYLE 1:
PIN 1. CATHODE
2. N/A
3. ANODE
4. CATHODE

TO-220 FULLPAK, 2-LEAD CASE 221AG ISSUE A

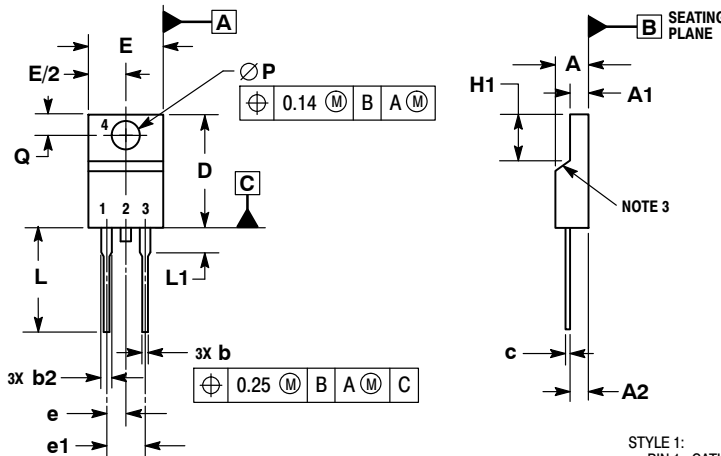

- NOTES:
1. DIMENSIONING AND TOLERANCING PER ASME Y14.5M, 1994.
2. CONTROLLING DIMENSION: MILLIMETERS.
3. CONTOUR UNCONTROLLED IN THIS AREA.
4. DIMENSIONS D AND E DO NOT INCLUDE MOLD FLASH AND GATE PROTRUSIONS. MOLD FLASH AND GATE PROTRUSIONS NOT TO EXCEED 0.13 PER SIDE. THESE DIMENSIONS ARE TO BE MEASURED AT OUTERMOST EXTREME OF THE PLASTIC BODY.
5. DIMENSION b2 DOES NOT INCLUDE DAMBAR PROTRUSION. LEAD WIDTH INCLUDING PROTRUSION SHALL NOT EXCEED 2.00.

DIM	MILLIMETERS	
	MIN	MAX
A	4.30	4.70
A1	2.50	2.90
A2	2.50	2.90
b	0.54	0.84
b2	1.10	1.40
c	0.49	0.79
D	14.22	15.88
E	9.65	10.67
e	2.54 BSC	
e1	5.08 BSC	
H1	5.97	6.48
L	12.70	14.73
L1	---	2.80
P	3.00	3.40
Q	2.80	3.20

- STYLE 1:
PIN 1. CATHODE
2. N/A
3. ANODE

ON Semiconductor and are registered trademarks of Semiconductor Components Industries, LLC (SCILLC). SCILLC owns the rights to a number of patents, trademarks, copyrights, trade secrets, and other intellectual property. A listing of SCILLC's product/patent coverage may be accessed at www.onsemi.com/site/pdf/Patent-Marking.pdf. SCILLC reserves the right to make changes without further notice to any products herein. SCILLC makes no warranty, representation or guarantee regarding the suitability of its products for any particular purpose, nor does SCILLC assume any liability arising out of the application or use of any product or circuit, and specifically disclaims any and all liability, including without limitation special, consequential or incidental damages. "Typical" parameters which may be provided in SCILLC data sheets and/or specifications can and do vary in different applications and actual performance may vary over time. All operating parameters, including "Typicals" must be validated for each customer application by customer's technical experts. SCILLC does not convey any license under its patent rights nor the rights of others. SCILLC products are not designed, intended, or authorized for use as components in systems intended for surgical implant into the body, or other applications intended to support or sustain life, or for any other application in which the failure of the SCILLC product could create a situation where personal injury or death may occur. Should Buyer purchase or use SCILLC products for any such unintended or unauthorized application, Buyer shall indemnify and hold SCILLC and its officers, employees, subsidiaries, affiliates, and distributors harmless against all claims, costs, damages, and expenses, and reasonable attorney fees arising out of, directly or indirectly, any claim of personal injury or death associated with such unintended or unauthorized use, even if such claim alleges that SCILLC was negligent regarding the design or manufacture of the part. SCILLC is an Equal Opportunity/Affirmative Action Employer. This literature is subject to all applicable copyright laws and is not for resale in any manner.

PUBLICATION ORDERING INFORMATION

LITERATURE FULFILLMENT:
Literature Distribution Center for ON Semiconductor
P.O. Box 5163, Denver, Colorado 80217 USA
Phone: 303-675-2175 or 800-344-3860 Toll Free USA/Canada
Fax: 303-675-2176 or 800-344-3867 Toll Free USA/Canada
Email: orderlit@onsemi.com

N. American Technical Support: 800-282-9855 Toll Free
USA/Canada
Europe, Middle East and Africa Technical Support:
Phone: 421 33 790 2910
Japan Customer Focus Center
Phone: 81-3-5817-1050

ON Semiconductor Website: www.onsemi.com
Order Literature: <http://www.onsemi.com/orderlit>
For additional information, please contact your local Sales Representative