

SHARP

SPEC. No. DG-045008

CONPOUND SEMICONDUCTOR DEVICES DIVISION

ISSUE May-20-04
Reference

ELECTRONIC COMPONENTS GROUP

SHARP CORPORATION

Technical literature

DEVICE SPECIFICATION FOR
LIGHT EMITTING DIODE

MODEL No.

GM5BW01300A

Specified for

CUSTOMERS' APPROVAL

Date _____

By _____

PRESENTED

Date May 21, 2004

By M. Katoh

M.Katoh,
Department General Manager of
Electronic Components Group
SHARP CORPORATION

SHARP

SPEC. No. DG-045008

ISSUE May-20-04
Reference

CONPOUND SEMICONDUCTOR DEVICES DIVISION

ELECTRONIC COMPONENTS GROUP

SHARP CORPORATION

Technical literature

DEVICE SPECIFICATION FOR
LIGHT EMITTING DIODE

MODEL No.

GM5BW01300A

Specified for

CUSTOMERS' APPROVAL

Date _____

By _____

PRESENTED

Date _____

By _____

M.Katoh,
Department General Manager of
Electronic Components Group
SHARP CORPORATION

PRODUCT NAME	Light Emitting Diode
MODEL No.	GM5BW01300A

1. These specification sheets include materials protected under the copyright of Sharp Corporation ("Sharp"). Please do not reproduce or cause anyone to reproduce them without Sharp's consent.
2. When using this product, please observe the absolute maximum ratings and the instructions for use outlined in these specification sheets, as well as the precautions mentioned below. Sharp assumes no responsibility for any damage resulting from use of the product which does not comply with the absolute maximum ratings and the instructions included in these specification sheets, and the precautions mentioned below.

(Precautions)

 - (1) This products is designed for use in the following application areas:

<ul style="list-style-type: none"> * OA equipment * Audio visual equipment * Home appliance * Telecommunication equipment (Terminal) * Measuring equipment * Tooling machines * Computers
--

If the use of the product in the above application areas is for equipment listed in paragraphs (2) or (3), please be sure to observe the precautions given in those respective paragraphs.
 - (2) Appropriate measures, such as fail-safe design and redundant design considering the safety design of the overall system and equipment, should be taken to ensure reliability and safety when this product is used for equipment which demands high reliability and safety in function and precision, such as ;

<ul style="list-style-type: none"> * Transportation control and safety equipment (aircraft, train, automobile etc.) * Traffic signals * Gas leakage sensor breakers * Rescue and security equipment * Other safety equipment

 - (3) Please do not use this product for equipment which require extremely high reliability and safety in function and precision, such as ;

<ul style="list-style-type: none"> * Space equipment * Telecommunication equipment (for trunk lines) * Nuclear power control equipment * Medical equipment
--
 - (4) Please contact and consult with a Sharp sales representative if there are any questions regarding interpretation of the above three paragraphs.
3. Please contact and consult with a Sharp sales representative for any questions about this product.

SHARP**Reference**GM5BW01300A specification

1. Application

This specification applies to the light emitting diode device Model No. GM5BW01300A
[InGaN/SiC Blue chip + Phosper LED device]

2. Outline dimensions and terminal connections ----- Refer to the attached sheet Page 3.

3. Ratings and characteristics ----- Refer to the attached sheet Page 4 ~ 6.

- 3-1. Absolute maximum ratings
- 3-2. Electro-optical characteristics
- 3-3. Derating Curve
- 3-4. Characteristics Diagram

4. Reliability ----- Refer to the attached sheet Page 7.

- 4-1. Test items and test conditions
- 4-2. Failure judgement criteria

5. Supplement----- Refer to the attached sheet Page 9 ~ 11

- 5-1. Taping
- 5-2. Packing Specification
- 5-3. Label
- 5-4. Environment

6. Precautions for use ----- Refer to the attached sheet Page 12 ~ 13

- 6-1. Precautions matters for designing circuit
- 6-2. Soldering
- 6-3. Cleaning method

SHARP

Reference

2. Outline dimensions and terminal connections

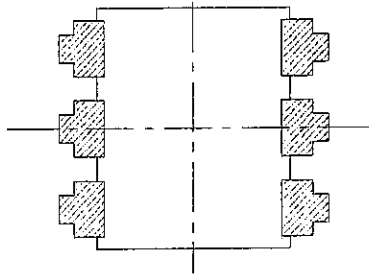
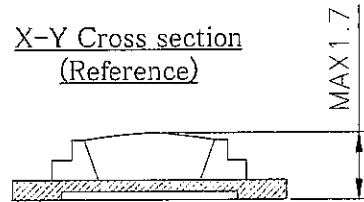
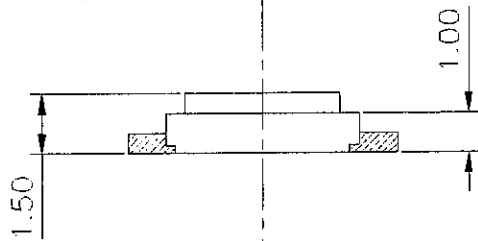
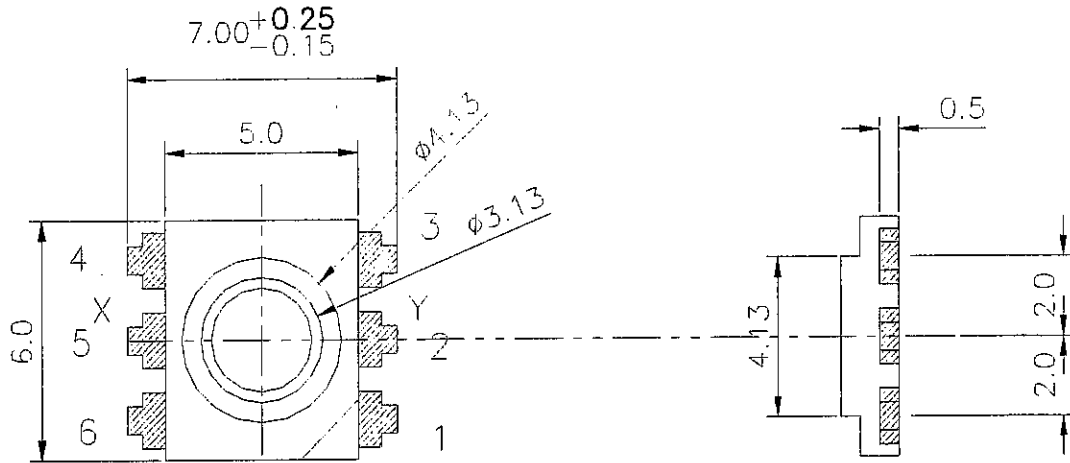

Internal connection diagram

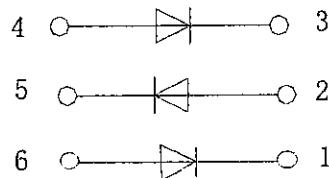

Note.

- 1. Unspecified tolerance to be ± 0.3
- 2. Dimensions in () are Values that is design of the mold.

unit	Material	Finish	
mm			51510003-1

SHARP**Reference**

3. Ratings and characteristics

3-1. Absolute maximum ratings

(Ta=25 °C)

Parameter	Symbol	Rating	Unit
Power dissipation	P	400	mW
Continuous forward current(*1)	I _F	50	mA
Peak forward current(*2)	I _{FM}	120	mA
Derating factor	DC	0.83	mA/°C
	Pulse	2.00	mA/°C
Reverse voltage	V _R	5	V
Operating temperature	Topr	-30 to +85	°C
Storage temperature	Tstg	-40to +85	°C
Soldering temperature (*3) Electrostatic Discharge	Tsol	295	°C
Threshold (Humanbody mode)	HBM	1000	V

(*1) Rating of each chip. Using plural chips, within power dissipation.

(*2) Duty ratio = 1/20, Pulse width = 0.1 s

(*3) Manual Soldering Max. 3 seconds.

3-2. Electro-optical characteristics

(Ta=25 °C)

Parameter	Symbol	Condition	MIN.	TYP.	MAX.	Unit
Forward Voltage*4	V _F		-	3.4	4.5	V
Luminous intensity*5 (3 chips lit on)	I _V	I _F =35 mA	-	4	-	cd
			chromaticity*6 (typ.)	region	x	y
			0.31	0.31		
Reverse Current*4	I _R	V _R =4V	-	-	100	μA

(*4) Rating of each chip

(*5) Measured by EG&G MODEL550(Radiometer/Photometersystem) after 20ms drive
(Tolerance : ±15%)(*6) Measured by Ohtsuka electronics MODEL MCPD-2000 after 9.6ms drive
(Tolerance : x,y:±0.02)



Reference

3-3. Derating Curve

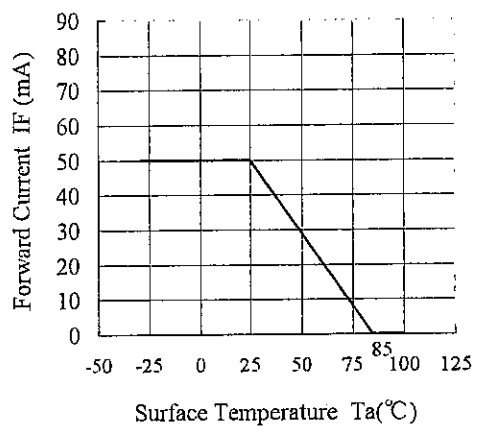

Forward Current Derating Curve

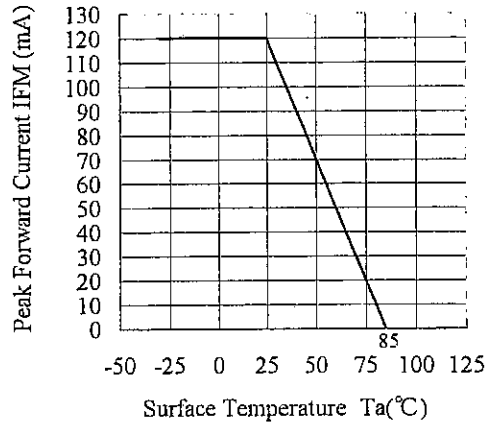

Peak Forward Current Derating Curve

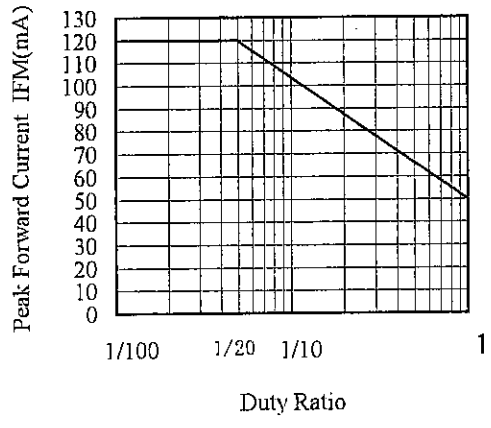

Peak Forward Current vs. Duty Ratio ($T_a = 25^\circ\text{C}$)

*Each curve shows lighting each chip.

SHARP

Reference

3-4. Characteristics Diagram (TYP.) (*1)

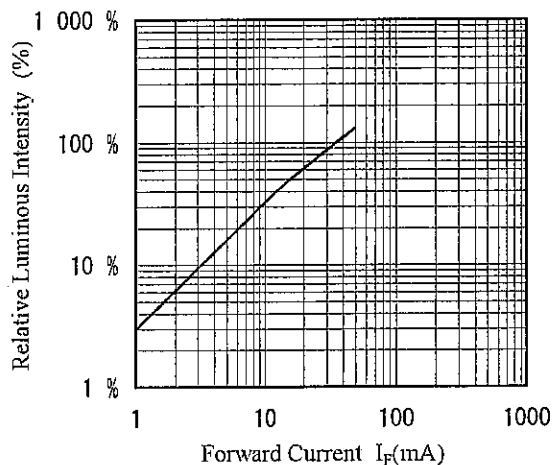

Relative Luminous Intensity vs. Forward Current ($T_a=25^\circ\text{C}$)

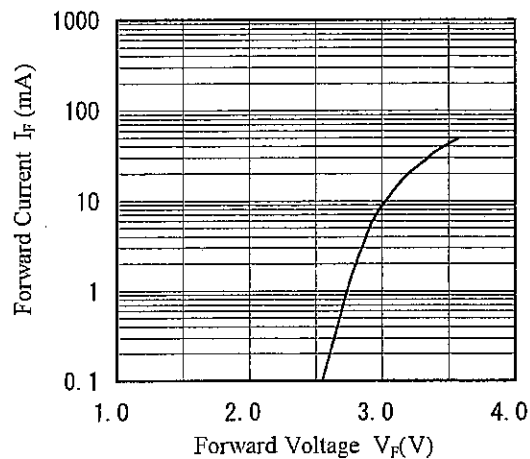

Forward Current vs. Forward Voltage ($T_a=25^\circ\text{C}$)

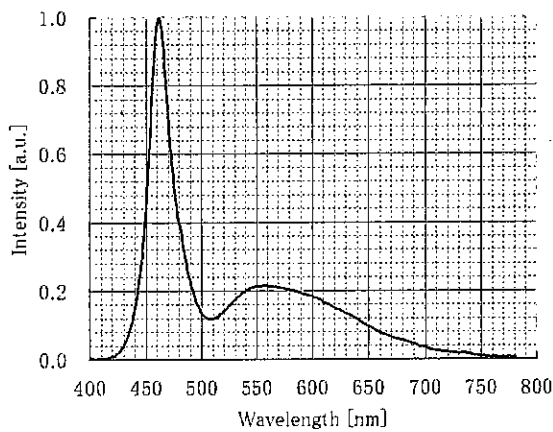

Spectrum

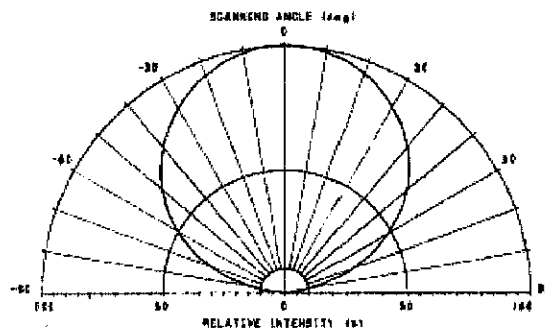

Directivity

(*1) Above characteristics data are typical data and not a guaranteed data

SHARP

Reference

4. Reliability

The reliability of products shall be satisfied with items listed below.

4-1. Test items and test conditions

Confidence level: 90%

No.	Test items	Test conditions	Samples n	Defective C	LTPD (%)
1	Temperature cycle	-40 °C(30 min)~+85 °C(30 min),30 times	22	0	10
2	High temp and high humidity storage	Ta=+60 °C, RH=90 %, t=1 000 h	22	0	10
3	High temperature storage	Ta=85°C, t=1 000 h	22	0	10
4	Low temperature storage	Ta=-40°C, t=1 000 h	22	0	10
5	Operating test	Ta=25 °C, IF=35mA, t=1 000 h	22	0	10
6	Mechanical shock test	15 000 m/s ² , 0.5 ms ± X · ± Y · ± Z direction, 3 times	11	0	20
7	Variable frequency vibration	200 m/s ² , 100~2 000~100 Hz / sweep for 4 min. X · Y · Z direction, 4 times	11	0	20
8	Soldering heat	Refer to the attached sheet, Page 12/13, 2 times	11	0	20
9	Solder ability (Dip Method)	240 ± 5°C, 5s Prior disposition : Dip in login flux.	11	0	20

4-2. Failure judgement criteria (*1)

4-2-1 Temperature cycle , High temp and high humidity storage , High temperature storage ,
Low temperature storage , Operating test , Mechanical shock test , Variable frequency vibration ,
Soldering heat

No.	Parameter	Symbol	Failure judgement criteria (*2)
1	Forward voltage	V _F	V _F > U.S.L × 1.2
2	Reverse current	I _R	I _R > U.S.L × 2.0
3	Luminous intensity	I _V	I _v < Initial value × 0.5, I _v > Initial value × 2.0

*1 : Measuring condition is accordance with specification.

*2 : U.S.L. is shown by Upper Specification Limit.

4-2-2 Solder ability

Solder shall be adhere at the area (The slant line part and back of the lead) of 95% or more of dipped portion.

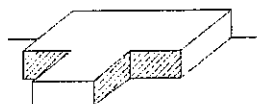

SHARP

Reference

5. Supplement

5-1. Taping

5-1-1. Shape and dimension of tape (Ref.)

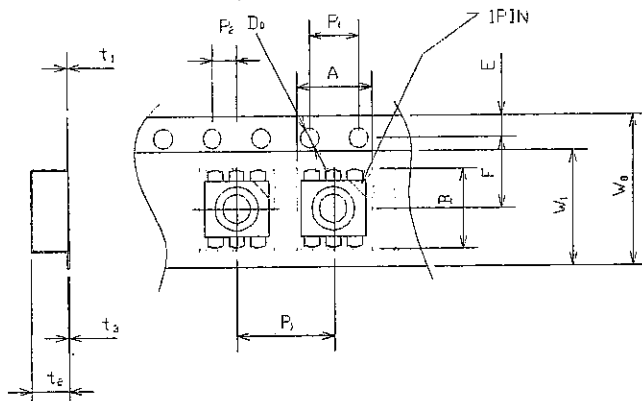

Parameter	Symbol	Dimension [mm] (Ref.)	Remarks	
Concave square hole for part insertion	Vertical	A	6.4	Dimension exclude a corner R at inside bottom
	Horizontal	B	7.4	
	Pitch	P_1	8.0	
Round sprocket hole	Diameter	D_0	1.55	Accumulated error $\pm 0.5\text{mm}/10$ pitch
	Pitch	P_0	4.0	
	Position	E	1.75	
Center to center distance	Vertical	P_2	2.0	Center line of the concave square hole and round sprocket hole
	Horizontal	F	7.5	
Cover tape	Width	W_1	14.0	
	Thickness	t_3	0.1	
Carrier tape	Width	W_0	16.0	
	Thickness	t_1	0.3	
Thickness of entire unit	t_2	1.75	With cover tape and carrier tape combined	

5-1-2. Shape and dimension of reel (Ref.)

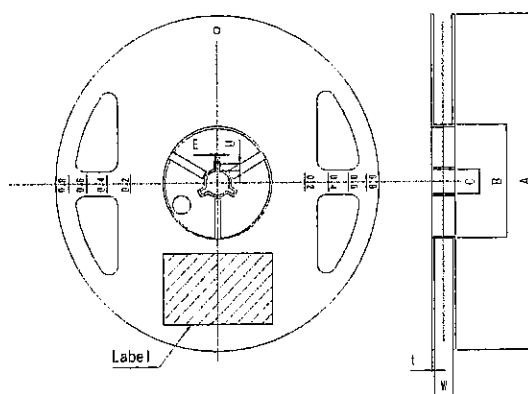

Parameter	Symbol	Dimension [mm](Ref.)	Remarks	
Frange	Diameter	A	ϕ 178	
	Thickness	t	1.5	
	Inner space direction	W	17.5	Dimension of shaft core
Hub	External diameter	B	ϕ 60	
	Spindle hole diameter	C	ϕ 13	
	Key slit	Width	E	2.0
		Depth	U	4.5
Notation for part name etc.		Labeling on the side of the frange.(part name, quantity, lot No.)		

※Material: polystyrene

SHARP

5-1-3. Taping specification

(1) Lead tape:

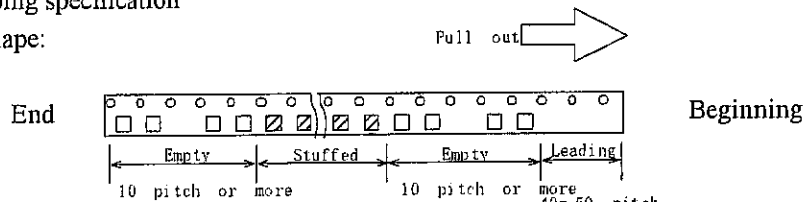

(2) Cover tape strength against peeling: $F=0.1\sim 0.8N$ ($\theta = 10^\circ$ or less)

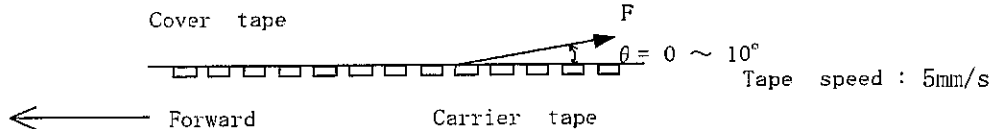

(3) Tape strength against bending:

The radius of bending circle should be 30mm or more.

If it is less than 30mm, the cover may peel.

(4) Jointing of tape: There should not be joint of cover tape or carrier tape.

(5) Quantity per reel: Average 800pcs. per reel

(6) Packing mass: 230g(One packing/Typ.)

(7) Product mass: 0.14g(One product/Typ.)

- (8) Others:
- ① There should not be missing above continuous three products.
 - ② Products should be easily taken out.
 - ③ Products should not be attached to the cover tape at peeling.

5-2. Packing specification

5-2-1. Dampproof package

In other to avoid the absorption of humidity in transport and storage, the device s are packed in aluminum sleeve.

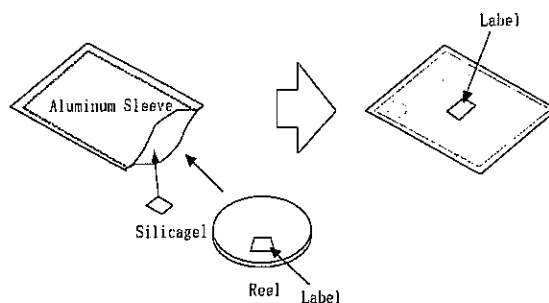

5-2-2. Strage conditions

Temperature : 5 to 30°C Humidity : less than 60%RH

5-2-3. Treatment after opening

(1) Please make a soldering within 7 days after opening under following condition;

Temperature : 5 to 30°C Humidity : less than 60%RH

(2) In case the devices are not used for a long time after opening ,the storage in dry box is recommendable. Or it is better to repack the devices with a desiccative by the sealer and put them in the some storage conditions as 4-2-2.

(3) Please make a soldering after a following baking treatment if unused term should be over the conditions of (2)

*Recommendable conditions:

- ① in taping
Temperature:60°C to 65°C,Time:36 to 48 hours 1time
- ② in individual (on PWB or metallic tray)
Temperature:100°Cto120°C .Time:more than 12 hours

SHARP**Reference**

5-3. Label

5-3. Label

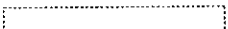
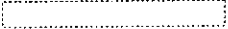
SHARP CORPORATION		
PART No.	GM5BW13200A	← Model number
QUANTITY	1000	← Quantity of products
		← EIAJ C-3 Bar code
		← EIAJ C-3 Bar code
LOT No.	KA01A01	← Lot number
(EIAJ C-3)	MADE IN JAPAN	← Production country

Lot Number

K A 0 1 A 0 1

① ② ③ ④ ⑤

- ① Production plant code(to be indicated alphabetically)
- ② Production lot(single or double figures)
- ③ Year of production(the last two figures of the year)
- ④ Month of production
(to be indicated alphabetically with January corresponding to 1)
- ⑤ Date of production(01~31)

5-4. Environment

5-4-1. Ozonosphere destructive chemicals.

- (1) The device doesn't contain following chemicals.
- (2) The device doesn't have a production line whose process requires following chemicals.
Banned chemicals : CFCs,halones,CCl₄,Trichloroethane(Methylchloroform)

5-4-2. Bromic non-burning materials

The device doesn't contain bromic non-burning materials(PBBOs,PBBs)

SHARP**Reference**

6. Precautions for use

6-1. Precautions matters for designing circuit

- When designing a circuit, please make sure that not to give a reverse voltage to the LED.
- There is a case that LED to be damaged with external stresses since the device is very small.
Please make sure that not to give any shock to the LED after assembling.
- Blue chip LED and fluorescent materials are used as luminescent materials.
Please note there is possibility to have color change in some degree depended on applied current.
- Please note there is possibility to damage your eyes when person look LED in face for long time.

6-2. Soldering

7-2-1. Reflow soldering

- (1) It is not recommended to exceed the soldering temperature and time shown below.
Caused by substrate bend or the other mechanical stress during reflow soldering may happen gold wire disconnection etc. Therefore please check and study your solder reflow machine's best condition.
- (2) In case of 2 times reflow process, 2nd reflow process should be done within 8 hours after 1st reflow process. (Storage condition ; at 30°C, RH less than 60%RH)
- (3) Reflow soldering temperature profile to be done under the following condition.

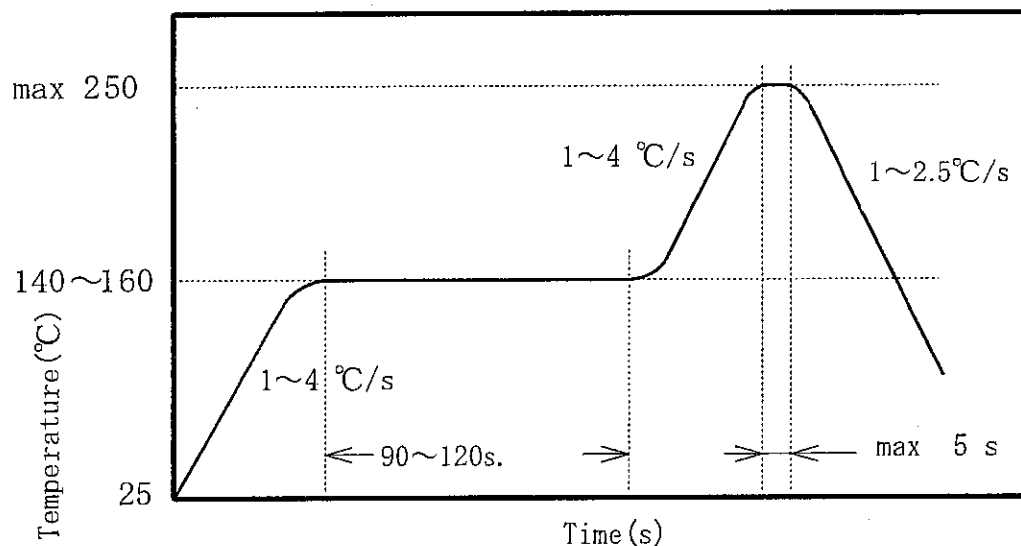

Fig. Reflow soldering temperature profile

SHARP**Reference**

6-2-2. Precaution for use

(1) Recommendable Metal Mask pattern for screen print

Recommend 0.15mm thickness metal mask for screen print. Caused by solder reflow condition, solder paste, substrate and the other material etc., may change solderability.

Please check and study actual solderability before usage.

Solder resist

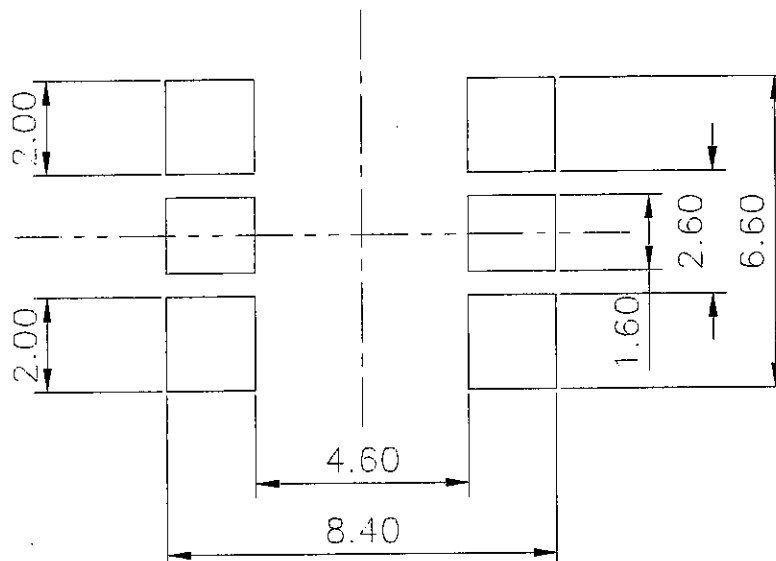

Note

- 1) Please do not mount any heating unit (resistor etc) on the rear surface of LED.
- 2) Heating unit should be located far from LED as much as possible.
- 3) In order to have enough heat radiation, please make pattern thick as much as possible. (Especially, against the lead of NO.2, 4, 6 → attached page 3)

6-3. Cleaning method

(1) Ultrasonic cleaning

The affect on the device from ultrasonic bath, ultrasonic output, duration, board size and device mounting method.

Test the cleaning method under actual conditions and check for abnormalities before actual use.

(2) Solvents

Use only the following types of solvent. And dry it rapidly after cleaning.

water, ethyl alcohol, isopropyl alcohol

Recommend conditions: R.T. 40kHz, 30W/l, 3 to 4 minutes